



ICD-PX470

4-595-544-13(1)



使用产品前请仔细阅读本使用说明书，并请妥善保管。

参阅帮助指南

您可以通过本使用说明书获取有关IC录音机的基本操作说明。帮助指南为在线手册。如果您希望了解进一步详情、操作方法以及遇到问题时可能的解决办法，请参阅帮助指南。

http://rd1.sony.net/help/icd/p47/h_cn/



检查附件

- IC录音机 (1)
- LR03 (7号) 碱性电池 (2)
- 使用说明书 (本页)
- 保修卡

部件和控制按钮

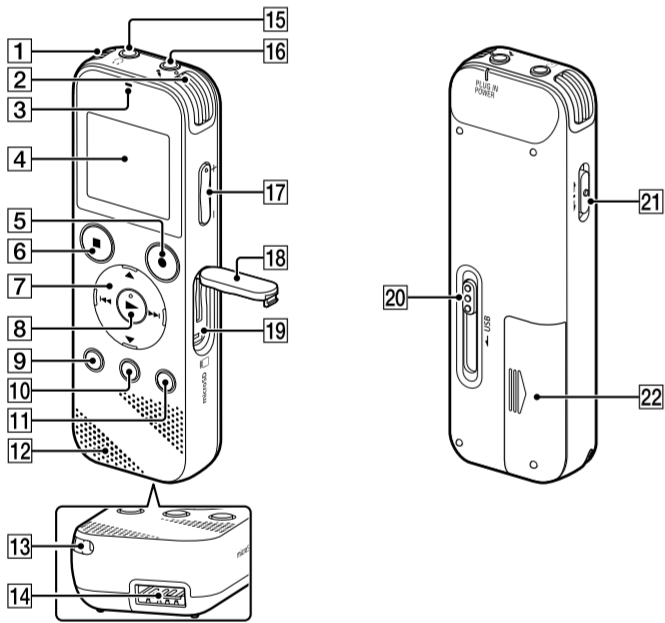

- 1 内置话筒 (立体声) (左)
- 2 内置话筒 (立体声) (右)
- 3 操作指示灯
- 4 显示窗口
- 5 ●REC/PAUSE (录音/暂停) 按钮
- 6 ■STOP按钮
- 7 控制按钮 (▲ DPC (Digital Pitch Control)、▼ A-B (重复A-B) / ◀ (回放/快退)、▶▶ (提示/快进))
- 8 ▶▶ (播放/确认) 按钮*
- 9 • BACK / ◀ HOME按钮 (• : 按下; •- : 按住)
- 10 T-MARK (曲目标记) 按钮
- 11 OPTION按钮
- 12 内置扬声器
- 13 腕带孔 (本IC录音机未随腕带。)
- 14 USB接口舱
- 15 ◯ (耳机) 插孔
- 16 ◯ (话筒) (PLUG IN POWER) 插孔*
- 17 VOL -/+ (音量 -/+) 按钮*
- 18 槽盖
- 19 microSD卡槽 (卡槽位于槽盖下面。)
- 20 USB滑杆
- 21 HOLD+POWER开关
- 22 电池仓

* ▶▶ (播放/确认) 按钮、VOL -/+ (音量 -/+) 按钮及 ◯ (话筒) (PLUG IN POWER) 插孔带有触觉点。可将这些触觉点用作操作IC录音机时的参考点。

让我们来试用您的新IC录音机

打开电源

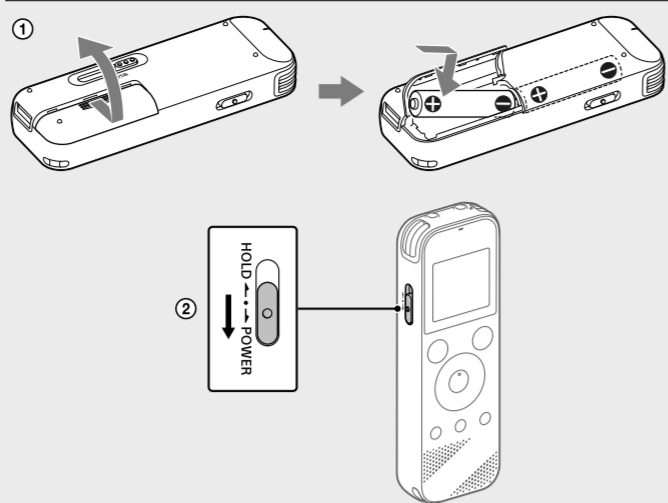

- ① 滑动并上提电池仓盖，按照正确的极性插入LR03 (7号) 碱性电池，然后盖上电池仓盖。

- ② 打开电源。

打开电源朝“POWER”方向滑动并按住HOLD+POWER开关，直到出现窗口显示为止。若要关闭电源，请朝“POWER”方向滑动并按住HOLD+POWER开关，直到显示窗口中出现“关机”为止。

防止误操作 (HOLD)朝“HOLD”方向滑动HOLD+POWER开关。

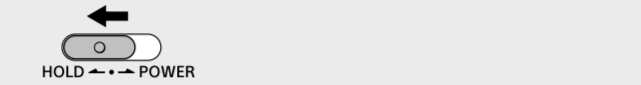

若要释放IC录音机的HOLD状态，请朝中心位置滑动HOLD+POWER开关。

进行初始设置

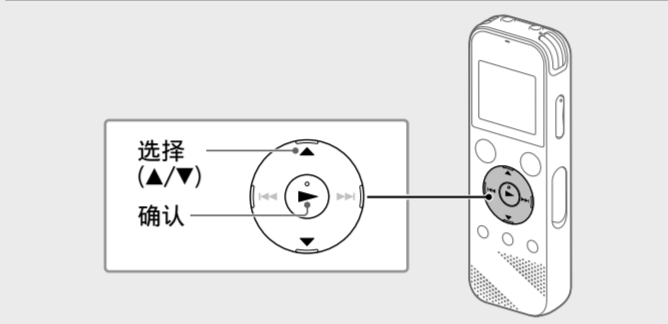

当您首次打开IC录音机电源时，显示窗口中会出现“配置初始设置”画面。然后，您就可以选择显示语言、设置时钟及开启/关闭提示音。

- ① 选择“是”开始初始设置。

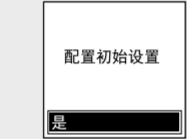

- ② 选择显示语言。可从以下语言中进行选择：简体中文*，English

* 默认设置

- ③ 设置当前年份、月份、日期、小时和分钟

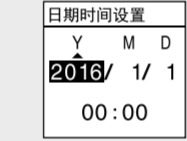

若要返回上一时钟设置项，请按BACK/HOME。

- ④ 选择“下一步”。

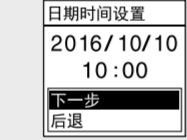

- ⑤ 选择“开”或“关”，开启或关闭提示音。完成初始设置后，将显示完成消息，随即显示HOME菜单画面。

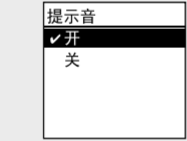

您可以稍后在任意时间更改初始设置。有关详细说明，请参阅帮助指南。

- 重新插入电池或更换新的电池时，将出现时钟设置显示窗口，同时显示在取出电池之前最后一次操作IC录音机时的大致日期和时间。请重新将时钟设为当前时间。
- 若要在初始设置之后检查当前时间，请朝“HOLD”方向滑动HOLD+POWER开关。

录音

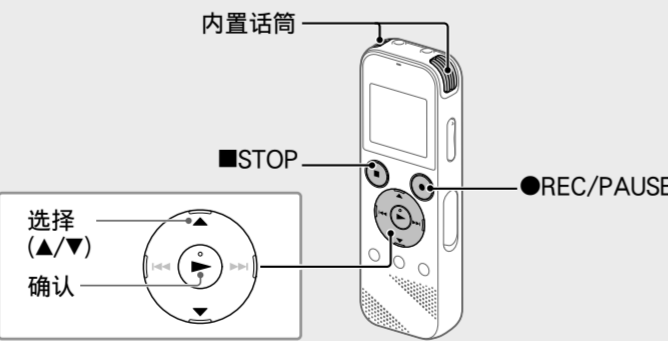

使用IC录音机之前，确保HOLD+POWER开关位于中心点位置。

- 通过在OPTION菜单中选择“场景选择”，可以选择适合各种环境的录音场景。

默认情况下，录制的音频文件存储在“□ 录音文件”下的“FOLDER01”中。

- ① 从HOME菜单中选择“♀ 录音”。

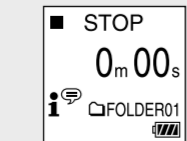

- ② 选择用于存储录音文件的文件夹。若要将音频文件存储到“FOLDER01”之外的文件夹中，请创建新的文件夹，然后将文件存储目的地更改为该新文件夹。有关详细说明，请参阅帮助指南。

- ③ 调整IC录音机的方向，使其内置话筒指向录制源的方向。

- ④ 按●REC/PAUSE。录音开始，显示窗口中出现“REC”，且操作指示灯呈红色亮起。若要定位音乐文件，请选择“所有歌曲”、“专辑”、“演出者”或“文件夹”。

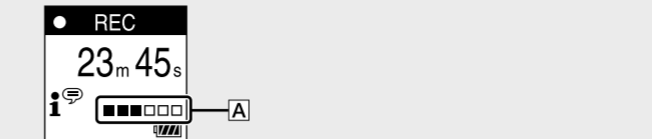

可选择用一个IC录音机录制的文件并进行播放。若要定位录音文件，请选择“最新录音”、“按录音日期搜索”、“按录音场景搜索”或“文件夹”。

- ⑤ 按■STOP停止录音。显示窗口中出现“正在保存...”，随即返回录音待机画面。

在停止录音之后，通过按▶▶可播放刚录制的文件。

聆听

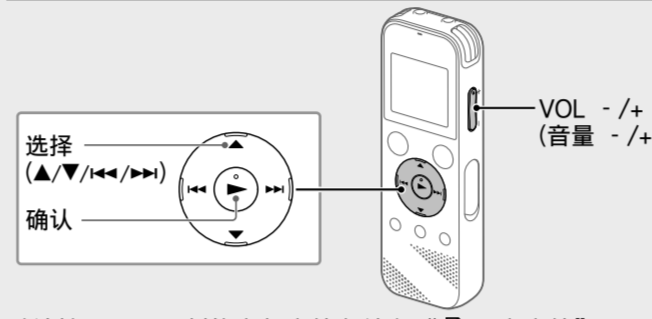

默认情况下，录制的音频文件存储在“□ 录音文件”下的“FOLDER01”中。

- ① 从HOME菜单中选择“□ 录音文件”。

- ② 选择“文件夹”-“内置内存”-“FOLDER01”，然后按▶▶。

- ③ 选择所需的文件。播放开始。



- ④ 按■STOP停止播放。

- 按VOL -/+调整音量。
- 内置扬声器主要用于检查录制的音频文件。如果发现音量不够大或难以听清录音内容，请使用耳机 (未附带)。
- 当选择“□ 录音文件”时，显示窗口中将出现所保存文件的文件搜索类别。您可以从“最新录音”、“按录音日期搜索”、“按录音场景搜索”或“文件夹”中选择一种搜索类别。

添加曲目标记
您可在稍后想要分割文件或确定播放位置的点添加曲目标记。每个文件最多可以添加98个曲目标记。也可在录音过程中添加曲目标记。

删除

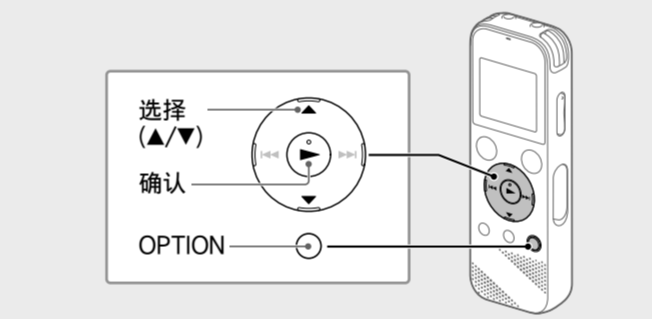

- 注
文件一旦删除，则无法恢复。

- ① 从录音文件列表中选择要删除的文件或播放要删除的文件。

- ② 从OPTION菜单中选择“删除文件”。

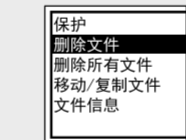

屏幕出现“要删除吗？”，同时播放选中的文件以供确认。

- ③ 选择“是”。

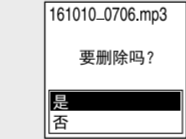

屏幕出现“请稍候”，直到选中的文件被删除。

使用HOME菜单

您可使用HOME菜单进行多种操作，包括定位和播放录音文件以及更改IC录音机的设置。

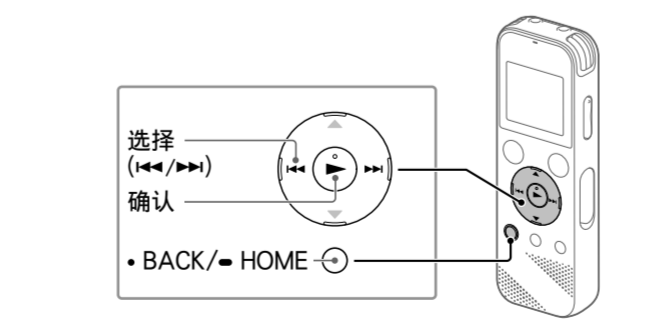

- ① 按住BACK/HOME。出现HOME菜单画面。



HOME菜单项按以下顺序排列。

音乐 ◀▶ □ ♀ ⚙ 设置 返回XX*

* 当前正在使用的功能显示在“XX”中。

- ② 请选择以下所需的功能：

♪ 音乐	可选择从一个从电脑导入的文件并进行播放。若要定位音乐文件，请选择“所有歌曲”、“专辑”、“演出者”或“文件夹”。
□ 录音文件	可选择用一个IC录音机录制的文件并进行播放。若要定位录音文件，请选择“最新录音”、“按录音日期搜索”、“按录音场景搜索”或“文件夹”。
♀ 录音	可显示录音待机画面，然后开始录音。
⚙ 设置	可显示设置菜单画面并更改IC录音机上的各种设置。
返回XX*	可返回到在HOME菜单画面之前所显示的画面。 * 当前正在使用的功能显示在“XX”中。

- 按■STOP将返回到进入HOME菜单之前所显示的画面。

使用OPTION菜单

您可使用OPTION菜单执行多种功能，包括更改IC录音机的设置。实际可用的项目因环境而异。

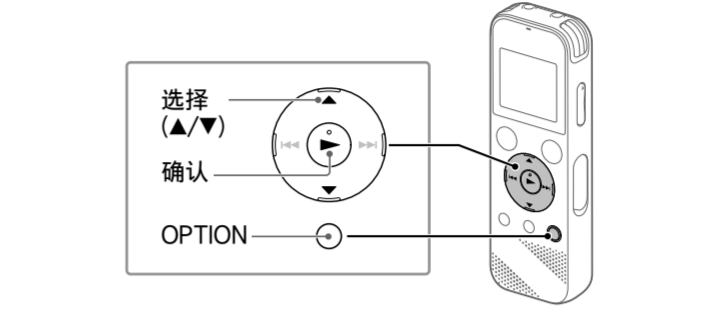

- ① 从HOME菜单选择所需的功能，然后按OPTION。

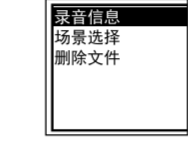

- ② 选择要更改其设置的菜单项。

- ③ 选择所需的设置选项。

将文件从IC录音机复制到电脑

可以将IC录音机的文件和文件夹复制到电脑上进行保存。

- ① 按箭头方向滑动USB滑杆，将USB接口插入正在运行的电脑的USB端口。

- ② 将要复制的文件或文件夹从“IC RECORDER”或“MEMORY CARD”拖放到电脑的本地磁盘上。

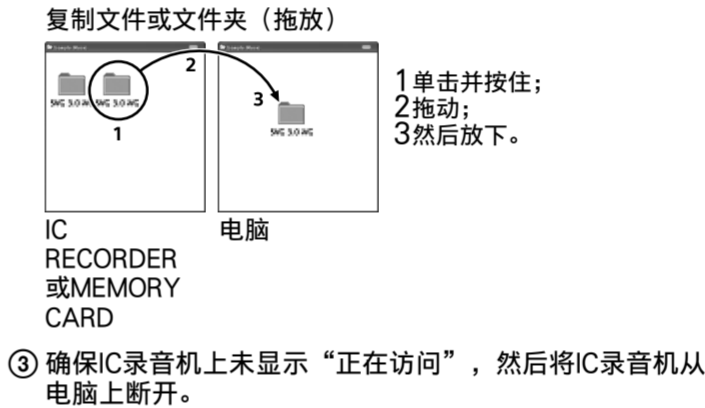

- ③ 确保IC录音机上未显示“正在访问”，然后将IC录音机从电脑上断开。

安装Sound Organizer 2

在电脑上安装Sound Organizer。Sound Organizer允许您在IC录音机和电脑之间交换文件。还可以播放从音乐CD或其他介质导入的歌曲、导入到电脑中的MP3及其他音频文件，并将其传输到IC录音机上。

- 注
• Sound Organizer仅支持Windows电脑。它不支持Mac。
- 本IC录音机仅支持Sound Organizer 2。

安装Sound Organizer时，需用具有管理员权限的帐户登录。

- ① 从您的电脑访问以下Sony服务网站：
<http://service.sony.com.cn/>

- ② 在上面的网站中，在搜索框中输入“Sound Organizer 2”查找Sound Organizer下载页面。

- ③ 按照下载页面上的指示下载并安装Sound Organizer。

注意事项

电源
直流 3.0 V：使用两节LR03 (7号) 碱性电池
直流 2.4 V：使用两节NH-AAA可充电电池
直流 5.0 V：额定输入电流 500 mA (USB供电时)

安全
驾车、骑车或操作任何机动车时请勿操作本机。

- 操作管理
- 请勿将本机靠近热源，或放置于阳光直射、灰尘很多或有机机械振动的地方。
 - 若有任何固体或液体落入本机，在进一步操作前，请取出电池并请有资格的人员进行检查。
 - 当使用IC录音机时，为了避免引起外壳翘曲或IC录音机故障，请遵守以下注意事项。
 - 请取出裤子后袋中的IC录音机后再坐下。
 - 将IC录音机放入袋中时，切勿将耳机线缠绕在播放器上并让袋子受到强烈冲击。
 - 小心不要让水溅洒到本机上。本机无防水功能。在以下情况下应特别注意。
 - 将本机放入口袋并使用洗手间等设施时。
 - 如果弯腰，机器可能会落入水中并可能受潮。
 - 在易受雨雪、湿气侵袭的环境中使用本机。
 - 在闷热出汗的环境中。如果用湿手触摸本机或将本机置于汗湿的口袋中，可能会使本机受潮。
 - 以高音量收听可能会影响您的听力。为了交通安全，请勿在驾车或骑车时使用本机。
 - 在周围空气非常干燥的情况下使用耳机可能会感到耳痛。这不是耳机问题，而是由于身体中积累的静电所致。可以身着防止产生静电的非合成纤维类衣物减少静电。

噪音
• 当本机放置于AC电源、荧光灯或手机旁进行录音或播放时，可能听到噪音。
- 当手指等物体在录音期间擦刮本机时，可能会录下噪音。

维护
清洁本机外表面时，请使用稍微蘸水的软布。然后用干燥的软布擦拭外表面。请勿使用酒精、汽油或稀释剂。

如果对本机有任何疑问或问题，请向最近的Sony经销商咨询。

警告

请勿将电池 (已安装的电池组或电池) 长时间暴露于例如阳光、火等极热的地方。

注意

如果使用不正确的电池类型更换电池有爆炸的危险。请按按照规定处理使用过的电池。

制造商：索尼 (中国) 有限公司
地址：北京市朝阳区太阳宫中路12号楼冠城大厦701
产地：广东省东莞市
产品标准：Q/CYSN00109
出版日期：2017年3月

规格

容量 (用户可用容量)*1*2)
4 GB (约3.20 GB=3435973837字节)

最长录音时间 (内置存储器)	
所有文件夹的最长录音时间如下。	
LPCM 44.1 kHz/16 bit	5小时20分钟
MP3 192 kbps*3	39小时45分钟
MP3 128 kbps	59小时35分钟
MP3 48 kbps (MONO)	159小时

■ 注
如果要长时间连续录音，您可能需要在录音期间更换新的电池。有关电池使用寿命的详情，请参阅“电池使用寿命”。本文中的最长录音时间仅供参考。

电池使用寿命			
使用Sony LR03 (SG) (7号) 碱性电池时 (JEITA) *4*5			
REC Mode	录音	用内置扬声器播放*6	用耳机播放
LPCM 44.1 kHz/16 bit	约40小时	约16小时	约37小时
MP3 192 kbps	约55小时	约18小时	约43小时

使用NH-AAA可充电电池时 (JEITA) *4*5			
REC Mode	录音	用内置扬声器播放*6	用耳机播放
LPCM 44.1 kHz/16 bit	约34小时	约12小时	约29小时
MP3 192 kbps	约40小时	约14小时	约34小时

尺寸 (宽/高/深) (不包括突起部分和控制按钮) (JEITA) *4
约38.3 mm × 114.1 mm × 19.3 mm

质量 (JEITA) *4

约74 g (含两节LR03 (7号) 碱性电池)

温度/湿度			
操作温度		5°C - 35°C	
操作湿度		25% - 75%	
贮藏温度		-10°C - +45°C	
贮藏湿度		25% - 75%	

支持的存储卡

从4 GB至32 GB的microSDHC卡

- 注
microSDXC卡与本IC录音机不兼容。

- *1少量内置存储器被用于文件管理，因此不能被作用用户存储。
- *2当用IC录音机格式化内置存储器时。
- *3录音场景的默认设置。
- *4测量值依据JEITA (Japan Electronics and Information Technology Industries Association) 标准测得
- *5电池使用寿命可能会缩短，视IC录音机的操作方式而定。
- *6当将音量设为27且以内置扬声器播放音乐时。

产品中有害物质的名称及含量

部件名称	有害物质					
	铅 (Pb)	汞 (Hg)	镉 (Cd)	六价铬 (Cr (VI))	多溴联苯 (PBB)	多溴二苯醚 (PBDE)
内置线路板	×	○	○	○	○	○
外壳	×	○	○	○	○	○
显示器	×	○	○	○	○	○
扬声器	×	○	○	○	○	○
电池	×	○	×	○	○	○
附件	○	○	○	○	○	○

本表格依据SJ/T 11364 的规定编制。
○：表示该有害物质在该部件所有均质材料中的含量均在GB/T 26572规定的限量要求以下。
×：表示该有害物质至少在该部件的某一均质材料中的含量超出GB/T 26572规定的限量要求。

商标

- Microsoft、Windows、Windows Vista和Windows Media是Microsoft Corporation在美国和/或其他国家的注册商标或商标。
- Mac OS是Apple Inc.在美国和其他国家的注册商标。
- MPEG Layer-3 音频编解码技术及Fraunhofer IIS和Thomson许可的专利。
- microSD、microSDHC和microSDXC徽标是SD-3C, LLC的商标。



所有其他商标和注册商标是其各自所有者的商标或注册商标。此外，本帮助指南并非在所有情况下均指明“™”和“®”。

This product is protected by certain intellectual property rights of Microsoft Corporation. Use or distribution of such technology outside of this product is prohibited without a license from Microsoft or an authorized Microsoft subsidiary.

“Sound Organizer 2” 使用说明：
Windows Media Format Runtime

许可

有关许可注意事项
本IC录音机随附的软件基于与软件所有者的许可协议的规定使用。根据这些软件程序版权所有者的要求，我们有义务告知用户下列事项。请阅读下列章节。
许可证 (英语) 记录在本IC录音机的内部存储器中。在IC录音机和电脑之间建立Mass Storage连接以阅读“LICENSE”文件夹中的许可证。

关于GNU GPL/LGPL的适用软件
本IC录音机中包含有符合下列GNU General Public License (在下文中称之为“GPL”) 或GNU Lesser General Public License (在下文中称之为“LGPL”) 规定的软件。该信息显示在附带的GPL/LGPL条款下，您有权访问、修改以及重新发布这些软件程序的源代码。
网上提供源代码。可通过下列网址下载源代码。
<http://www.sony.net/Products/Linux/>
有关源代码的内容问题，请不要与我们联系。
许可证 (英语) 记录在本IC录音机的内部存储器中。在IC录音机和电脑之间建立Mass Storage连接以阅读“LICENSE”文件夹中的许可证。

Operating Instructions



ICD-PX470

Refer to the Help Guide

This is the Operating Instructions, which provides you with instructions on the basic operations of the IC recorder. The Help Guide is an online manual. Refer to the Help Guide when you would like to know further details, operations and possible solutions when a problem occurs.

http://rd1.sony.net/help/icd/p47/h_cn/



Check the supplied items

- IC Recorder (1)
- LR03 (size AAA) alkaline batteries (2)
- Operating Instructions (this sheet)
- Warranty card

Parts and controls

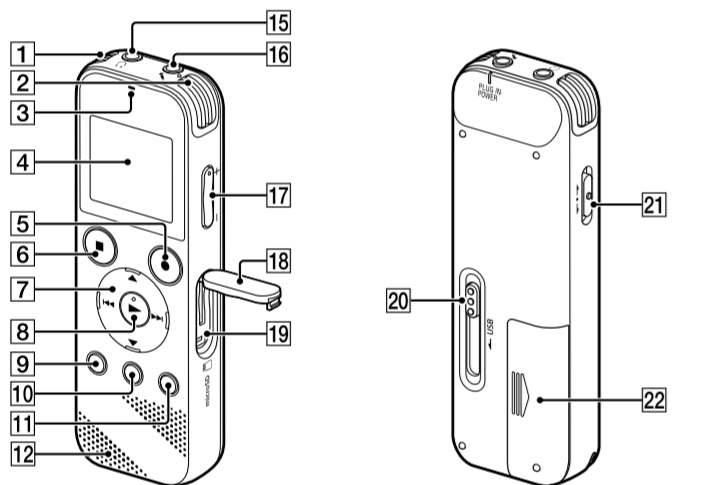

- Built-in microphones (stereo) (L)
- Built-in microphones (stereo) (R)
- Operation indicator
- Display window
- REC/PAUSE (record/pause) button
- STOP button
- Control button (▲ DPC (Digital Pitch Control), ▼◀ A-B (repeat A-B)/▶ (review/fast backward), ▶▶ (cue/fast forward))
- ▶ (play/enter) button*
- BACK/●HOME button (◦: press, ●: press and hold)
- T-MARK (track mark) button
- OPTION button
- Built-in speaker
- Strap hole (No strap is supplied with your IC recorder.)
- USB connector compartment
- 🎧 (headphones) jack
- 🎧 (microphone) (PLUG IN POWER) jack*
- VOL -/+ (volume -/+) button*
- Slot cover
- microSD card slot (The card slot is located under the cover.)
- USB slide lever
- HOLD+POWER switch
- Battery compartment

* The ▶ (play/enter) button, VOL -/+ (volume -/+) button, and 🎧 (microphone) (PLUG IN POWER) jack have a tactile dot. Use the tactile dot as a reference when operating the IC recorder.

Let's try out your new IC recorder

Power on

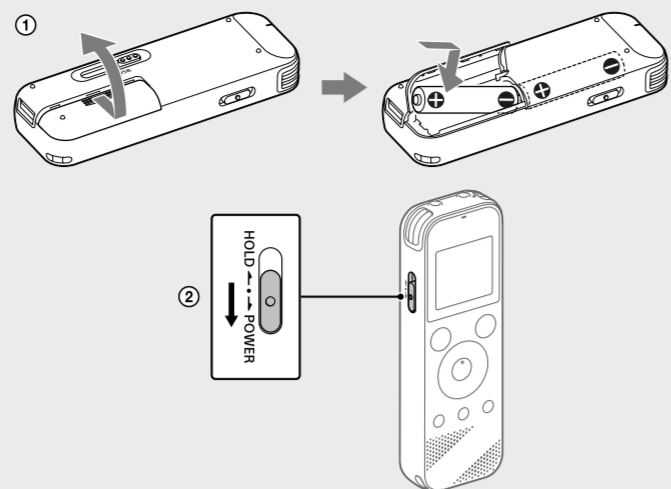

- Slide and lift the battery compartment lid, insert LR03 (size AAA) alkaline batteries with the correct polarity, and close the lid.
- Turn the power on.

To turn the power on
Slide and hold the HOLD+POWER switch in the direction of "POWER" until the window display appears.
To turn the power off, slide the HOLD+POWER switch to "POWER" and hold it until "关机" appears on the display window.

To prevent unintentional operations (HOLD)
Slide the HOLD+POWER switch in the direction of "HOLD."

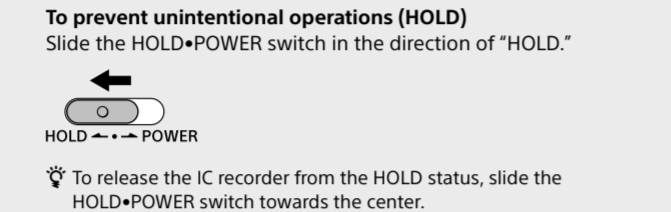

Initial settings

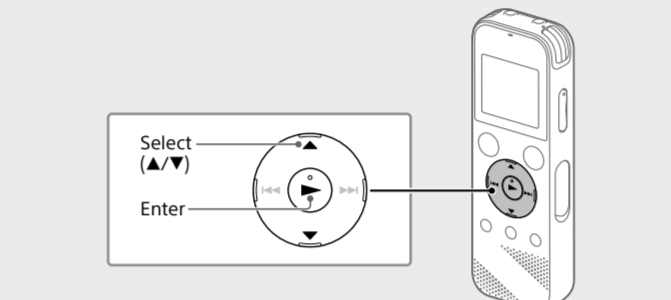

When you turn on your IC recorder for the first time, the "配置初始设置" screen appears on the display window. You can then select the display language, set the clock, and turn on/off the beep sound.

- Select "是" to start the initial settings.
- Select the display language. You can select from the following languages: 简体中文 (Simplified Chinese), English
* Default setting
- Set the current year, month, day, hour, and minute.
- Select "下一步".
- Select "开" or "关" to turn on or off the beep sound. When the initial settings finish, the completion message and then the HOME menu screen appears.

- You can change any of the initial settings at any time later. For detailed instructions, refer to the Help Guide.
- When you re-insert batteries, or when you replace batteries with new ones, the clock setting display appears, and the approximate date and time when you last operated the IC recorder before removing the batteries is displayed. Set the clock to the current time again.
- To check the current time after the initial settings, slide the HOLD+POWER switch in the direction of "HOLD."

Record

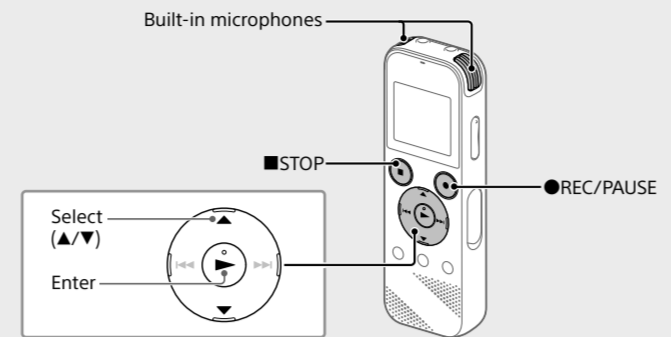

- Before you start using the IC recorder, make sure that the HOLD+POWER switch is at the center dot position.
 - You can select a recording scene for each situation by selecting "场景选择" in the OPTION menu.
- Recorded audio files are stored in "FOLDER01" under "录音文件" by default.

- Select "录音" from the HOME menu. The recording standby screen appears on the display window.
- Select the folder you want to store the recorded files. To store the audio files in a folder other than "FOLDER01," create a new folder and change the file storage destination folder to the new folder. For detailed instructions, refer to the Help Guide.
- Turn the IC recorder so that its built-in microphones point in the direction of the recording source.
- Press ●REC/PAUSE. Recording starts, "REC" appears on the display, and the operation indicator lights in red. Pressing and holding the ●REC/PAUSE does not start recording. Doing so makes your IC recorder pause for recording.

During recording, the recording level guide (A) is displayed. Adjust the orientation of the built-in microphones, the distance from the sound source, or the sensitivity setting of the microphones so that the input level indicated by ■ stays at 3/6 or 4/6, which fits within the optimum range, as illustrated above.

- Press ■STOP to stop recording. "正在保存..." appears on the display, and then the display returns to the record standby screen. After you stopped recording, you can press ▶ to play the file you have just recorded.

Listen

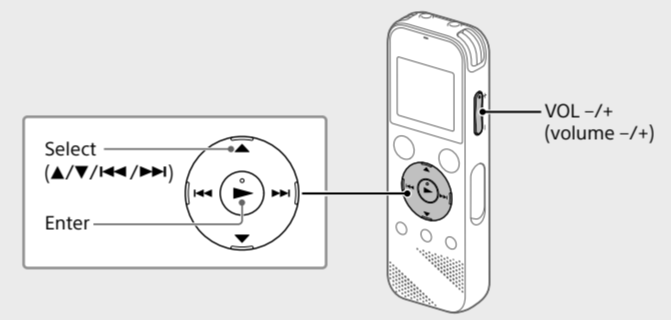

Recorded audio files are stored in "FOLDER01" under "录音文件" by default.

- Select "录音文件" from the HOME menu.
- Select "文件夹" - "内置内存" - "FOLDER01," and then press ▶. To listen to recorded audio files stored on a microSD card, select "文件夹" - "SD 卡."
- Select your desired file. Playback starts.
- Press ■STOP to stop playback.
 - Press VOL -/+ to adjust the volume.
 - The built-in speaker is provided mainly for checking recorded audio files. If you find the volume not loud enough or have difficulty in understanding what you hear, use headphones (not supplied).
 - When you select "录音文件," the file search categories of the stored files appear on the display window. You can select one of the search categories from "最新录音," "按录音日期搜索," "按录音场景搜索," or "文件夹."

To add a track mark
You can add a track mark at a point at which you want to divide a file later or locate during playback. You can add a maximum of 98 track marks to each file. You can also add track marks during a recording.

Delete

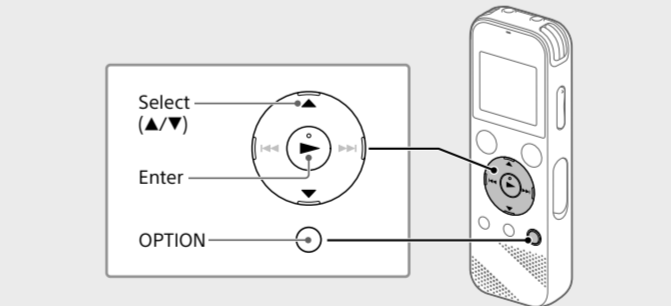

- Once a file is deleted, you cannot restore it.

- Select the file you want to delete from the list of recorded files or play back the file you want to delete.
- Select "删除文件" from the OPTION menu.

"要删除吗?" appears and the selected file starts playing for your confirmation.
- Select "是."

"请稍候" appears and stays until the selected file is deleted.

Using the HOME menu

You can use the HOME menu for a variety of operations, including locating and playing a recorded file and changing the settings of your IC recorder.

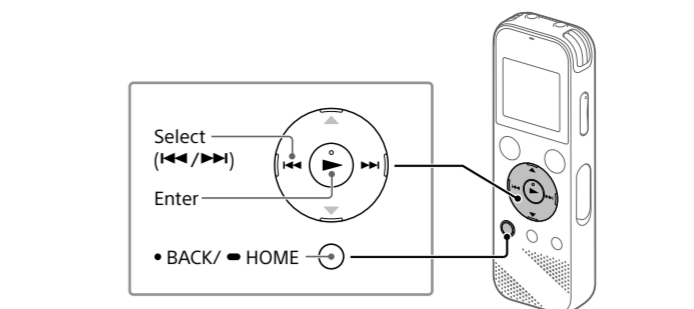

- Press and hold BACK/HOME. The HOME menu screen appears.

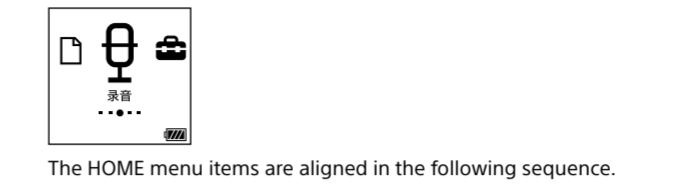

The HOME menu items are aligned in the following sequence.

- Select your desired function from the following:
 - 音乐: You can select and play one of the files you have imported from a computer. To locate a music file, select "所有歌曲," "专辑," "演出者" or "文件夹."
 - 录音文件: You can select and play one of the files you have recorded with your IC recorder. To locate a recorded file, select "最新录音," "按录音日期搜索," "按录音场景搜索," or "文件夹."
 - 录音: You can display the record standby screen, and then start recording.
 - 设置: You can display the 设置 menu screen and change various settings on the IC recorder.
 - 返回 XX*: You can go back to the screen that was displayed before the HOME menu screen. * The function you are currently using is displayed in "XX."

Press ■STOP to return to the screen displayed before you entered the HOME menu.

Using the OPTION menu

You can use the OPTION menu to perform a variety of functions, including changing the settings of your IC recorder. The available items differ depending on the situation.

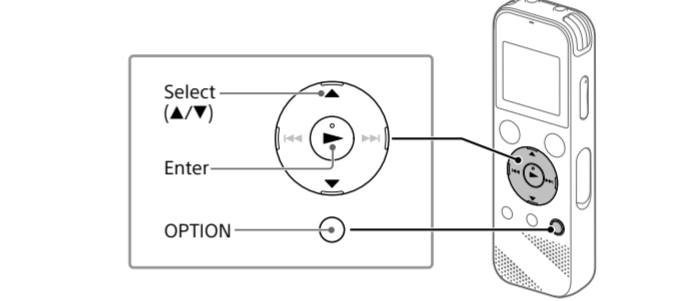

- Select your desired function from the HOME menu, and then press OPTION.
- Select the menu item for which you want to change the setting.
- Select your desired setting option.

Copying files from your IC recorder to a computer

You can copy the files and folders from your IC recorder to a computer to store them.

- Slide the USB slide lever in the direction of the arrow, and insert the USB connector into the USB port of a running computer.
- Drag and drop the files or folders you want to copy from "IC RECORDER" or "MEMORY CARD" to the local disk on the computer.

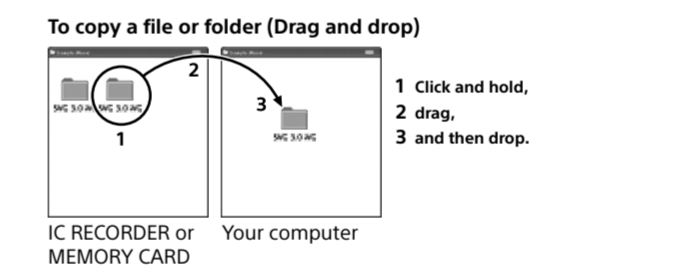

- Make sure that "正在访问" is not displayed on the display window of your IC recorder, and then disconnect the IC recorder from the computer.

Installing Sound Organizer 2

Install Sound Organizer on your computer. Sound Organizer allows you to exchange files between your IC recorder and your computer. Songs imported from music CDs and other media, MP3 and other audio files imported to a computer can also be played and transferred to the IC recorder.

- Sound Organizer is compatible with Windows computers only. It is not compatible with Mac.
- This IC recorder is compatible with Sound Organizer 2 only.

When installing Sound Organizer, log in to an account with administrator privileges.

- Access the following Sony Service web site from your computer: <http://service.sony.com.cn/>
- On the above web site, enter "Sound Organizer 2" in the search box to locate the Sound Organizer download page.
- Follow the procedures instructed on the download page to download and then install the Sound Organizer.

Precautions

- On power**
DC 3.0 V: Use two LR03 (size AAA) alkaline batteries
DC 2.4 V: Use two NH-AAA rechargeable batteries
DC 5.0 V: Rated current consumption 500 mA (powered by USB)

- On safety**
Do not operate the unit while driving, cycling or operating any motorized vehicle.

- On handling**
 - Do not leave the unit in a location near heat sources, or in a place subject to direct sunlight, excessive dust, or mechanical shock.
 - Should any solid object or liquid fall into the unit, remove the batteries and have the unit checked by qualified personnel before operating it any further.
 - When using your IC recorder, remember to follow the precautions below in order to avoid warping the cabinet or causing the IC recorder to malfunction.
 - Do not sit down with the IC recorder in your back pocket.
 - Do not put your IC recorder into a bag with the headphones/earphones cord wrapped around it and subject the bag to strong impact.
 - Be careful not to allow water to splash on the unit. The unit is not waterproof. In particular, be careful in the following situations.
 - When you have the unit in your pocket and go to the bathroom, etc. When you bend down, the unit may drop into the water and may get wet.
 - When you use the unit in an environment where the unit is exposed to rain, snow, or humidity.
 - In circumstances where you get sweaty. If you touch the unit with wet hands or if you put the unit in the pocket of sweaty clothes, the unit may get wet.
 - Listening with this unit at high volume may affect your hearing. For traffic safety, do not use this unit while driving or cycling.

- You may feel pain in your ears if you use the headphones when the ambient air is very dry.
- This is not because of a malfunction of the headphones, but because of static electricity accumulated in your body. You can reduce static electricity by wearing non-synthetic clothes that prevent the emergence of static electricity.

- On noise**
 - Noise may be heard when the unit is placed near an AC power source, a fluorescent lamp or a mobile phone during recording or playback.
 - Noise may be recorded when an object, such as your finger, etc., rubs or scratches the unit during recording.

- On maintenance**
To clean the exterior, use a soft cloth slightly moistened in water. Then use a soft dry cloth to wipe the exterior. Do not use alcohol, benzine or thinner.

If you have any questions or problems concerning your unit, please consult your nearest Sony dealer.

WARNING

Do not expose the batteries (battery pack or batteries installed) to excessive heat such as sunshine, fire or the like for a long time.

CAUTION

Risk of explosion if battery is replaced by an incorrect type. Dispose of used batteries according to the instructions.

Specifications

Capacity (User available capacity)2**
4 GB (approx. 3.20 GB = 3,435,973,837 Byte)

Maximum recording time (Built-in memory)		
The maximum recording time of all the folders is as follows.		
LPCM 44.1 kHz/16 bit	5 hours 20 minutes	
MP3 192 kbps*3	39 hours 45 minutes	
MP3 128 kbps	59 hours 35 minutes	
MP3 48 kbps (MONO)	159 hours	

Note
When you are going to record continuously for a long time, you may have to replace the batteries with new ones in the middle of recording. For details on the battery life, see Battery Life. The maximum recording time in this topic is for your reference only.

Battery Life
When using Sony LR03 (5G) (size AAA) alkaline batteries (JEITA)**4

REC Mode	Recording	Playback with the built-in speaker**6	Playback with the headphones
LPCM 44.1 kHz/16 bit	Approx. 40 hours	Approx. 12 hours	Approx. 37 hours
MP3 192 kbps	Approx. 55 hours	Approx. 18 hours	Approx. 43 hours

When using NH-AAA rechargeable batteries (JEITA)**4

REC Mode	Recording	Playback with the built-in speaker**6	Playback with the headphones
LPCM 44.1 kHz/16 bit	Approx. 34 hours	Approx. 12 hours	Approx. 29 hours
MP3 192 kbps	Approx. 40 hours	Approx. 14 hours	Approx. 34 hours

Dimensions (w/h/d) (not incl. projecting parts and controls) (JEITA)4**
Approx. 38.3 mm × 114.1 mm × 19.3 mm

Mass (JEITA)4**
Approx. 74 g (including two LR03 (size AAA) alkaline batteries)

Temperature/Humidity

Operating temperature	5°C - 35°C
Operating humidity	25% - 75%
Storage temperature	-10°C - +45°C
Storage humidity	25% - 75%

Compatible memory cards
microSDHC cards from 4 GB to 32 GB

Note
microSDXC cards are not compatible with your IC recorder.

*1 A small amount of the internal memory is used for file management and therefore not available for user storage.
*2 When the built-in memory is formatted with the IC recorder.
*3 Default settings for the recording scenes.
*4 Measured value by the standard of JEITA (Japan Electronics and Information Technology Industries Association).
*5 The battery life may shorten depending on how you operate the IC recorder.
*6 When playing back music with the built-in speaker with the volume level set to 27.

Trademarks

- Microsoft, Windows, Windows Vista and Windows Media are registered trademarks or trademarks of Microsoft Corporation in the United States and/or other countries.
- Mac OS is a trademark of Apple Inc., registered in the USA and other countries.
- MPEG Layer-3 audio coding technology and patents licensed from Fraunhofer IIS and Thomson.
- microSD, microSDHC and microSDXC logos are trademarks of SD-3C, LLC.



All other trademarks and registered trademarks are trademarks or registered trademarks of their respective holders. Furthermore, "TM" and "®" are not mentioned in each in this manual.

This product is protected by certain intellectual property rights of Microsoft Corporation. Use or distribution of such technology outside of this product is prohibited without a license from Microsoft or an authorized Microsoft subsidiary.

The "Sound Organizer 2" uses software modules as shown below: Windows Media Format Runtime

License

Notes on the License
This IC recorder comes with software that are used based on licensing agreements with the owners of that software. Based on requests by the owners of copyright of these software applications, we have an obligation to inform you of the following. Please read the following sections. Licenses (in English) are recorded in the internal memory of your IC recorder. Establish a Mass Storage connection between the IC recorder and a computer to read licenses in the "LICENSE" folder.

On GNU GPL/LGPL applied software
The software that is eligible for the following GNU General Public License (hereinafter referred to as "GPL") or GNU Lesser General Public License (hereinafter referred to as "LGPL") are included in the IC recorder. This informs you that you have a right to have access to, modify, and redistribute source code for these software programs under the conditions of the supplied GPL/LGPL. Source code is provided on the web. Use the following URL to download it. <http://www.sony.net/Products/Linux/> We would prefer you do not contact us about the contents of source code. Licenses (in English) are recorded in the internal memory of your IC recorder. Establish a Mass Storage connection between the IC recorder and a computer to read licenses in the "LICENSE" folder.