



# Multi Audio Player System

## Operating Instructions

Getting started

Listening to a CD

Listening to the radio

Listening to a file on a USB device

Listening to music of an iPhone/iPad/iPod

Listening to music with connected components

Listening to music through a BLUETOOTH connection

Listening to music via a wireless network

Additional information

About "SongPal"

Troubleshooting

Precautions/Specifications

## WARNING

To reduce the risk of fire, do not cover the ventilation opening of the appliance with newspapers, tablecloths, curtains, etc. Do not expose the appliance to naked flame sources (for example, lighted candles).

To reduce the risk of fire or electric shock, do not expose this appliance to dripping or splashing, and do not place objects filled with liquids, such as vases, on the appliance.

As the main plug is used to disconnect the unit from the mains, connect the unit to an easily accessible AC outlet. Should you notice an abnormality in the unit, disconnect the main plug from the AC outlet immediately.

Do not install the appliance in a confined space, such as a bookcase or built-in cabinet.

Do not expose batteries or appliances with battery-installed to excessive heat, such as sunshine and fire.

The unit is not disconnected from the mains as long as it is connected to the AC outlet, even if the unit itself has been turned off.

This equipment has been tested and found to comply with the limits set out in the EMC Directive using a connection cable shorter than 3 meters.

Excessive sound pressure from earphones and headphones can cause hearing loss.

## CAUTION

The use of optical instruments with this product will increase eye hazard.

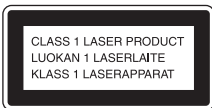

This appliance is classified as a CLASS 1 LASER product. This marking is located on the rear exterior.

For customers in Australia

This equipment should be installed and operated with at least 20 cm and more between the radiator and person's body (excluding extremities: hands, wrists, feet and ankles).

**Notice for customers: the following information is only applicable to equipment sold in countries applying EU directives.**

This product has been manufactured by or on behalf of Sony Corporation, 1-7-1 Konan Minato-ku Tokyo, 108-0075 Japan. Inquiries related to product

compliance based on European Union legislation shall be addressed to the authorized representative, Sony Deutschland GmbH, Hedelfinger Strasse 61, 70327 Stuttgart, Germany. For any service or guarantee matters, please refer to the addresses provided in the separate service or guarantee documents.

Hereby, Sony Corp., declares that this equipment is in compliance with the essential requirements and other relevant provisions of Directive 1999/5/EC. For details, please access the following URL: <http://www.compliance.sony.de/>



**Disposal of Old Electrical & Electronic Equipment (Applicable in the European Union and other European countries with separate collection systems)**

This symbol on the product or on its packaging indicates that this product shall not be treated as household waste. Instead it shall be handed over to the applicable collection point for the recycling of electrical and electronic equipment. By ensuring this product is disposed of correctly, you will help prevent potential negative consequences for the environment and human health, which could otherwise be caused by inappropriate waste handling of this product. The recycling of materials will help to conserve natural resources. For more detailed information about recycling of this product, please contact your local Civic Office, your household waste disposal service or the shop where you purchased the product.

## Europe Only



**Pb**

**Disposal of waste batteries (applicable in the European Union and other European countries with separate collection systems)**

This symbol on the battery or on the packaging indicates that the battery provided with this product shall not be treated as household waste. On certain batteries this symbol might be used in combination with a chemical symbol. The chemical symbols for mercury (Hg) or lead (Pb) are added if the battery contains more than 0.0005% mercury or 0.004% lead.

By ensuring these batteries are disposed of correctly, you will help prevent potentially negative consequences for the environment and human health which could otherwise be caused by inappropriate waste handling of the battery. The recycling of the materials will help to conserve natural resources.

In case of products that for safety, performance or data integrity reasons require a permanent

connection with an incorporated battery, this battery should be replaced by qualified service staff only.

To ensure that the battery will be treated properly, hand over the product at end-of-life to the applicable collection point for the recycling of electrical and electronic equipment.

For all other batteries, please view the section on how to remove the battery from the product safely. Hand the battery over to the applicable collection point for the recycling of waste batteries.

For more detailed information about recycling of this product or battery, please contact your local Civic Office, your household waste disposal service or the shop where you purchased the product.

---

## Before operating this system

Malfunctions that occur during the normal use of the system will be repaired by Sony in accordance with the conditions defined in the limited warranty for this system. However, Sony will not be liable for any consequences arising from a failure to play caused by a damaged or malfunctioning system.

### Music discs encoded with copyright protection technologies

This product is designed to playback discs that conform to the Compact Disc (CD) standard. Recently, various music discs encoded with copyright protection technologies are marketed by some record companies.

Please be aware that among those discs, there are some that do not conform to the CD standard and may not be playable by this product.

### Note on DualDiscs

A DualDisc is a two sided disc product which mates DVD recorded material on one side with digital audio material on the other side. However, since the audio material side does not conform to the Compact Disc (CD) standard, playback on this product is not guaranteed.

# Table of Contents

Before operating this system .....	3
------------------------------------	---

---

## Getting started

Location and Function of Controls .....	7
Inserting the batteries.....	10
Setting the clock.....	10

---

## Listening to a CD

Playing a CD-DA/MP3 disc .....	11
To change the play mode .....	11
Creating your own program (Program Play) .....	13

---

## Listening to the radio

Tuning in a radio station .....	14
Presetting radio stations .....	15
Running the DAB Automatic Scan manually .....	15

---

## Listening to a file on a USB device

Playing a file on a USB device.....	16
Connecting a USB device to the USB port on the front of the unit .....	16
Connecting a USB device to the USB port on the rear of the unit.....	17
Playable audio formats .....	17

---

## Listening to music of an iPhone/iPad/iPod

Playing an iPhone/iPad/iPod connected by USB .....	18
Playing back an iPhone/iPad/iPod over a wireless connection (AirPlay).....	18

---

## Listening to music with connected components

Playing back the music of connected components.....	19
---	----

---

## Listening to music through a BLUETOOTH connection

Pairing the system with a BLUETOOTH device and listening to music .....	20
Listening to music through a registered device .....	21
Listening to music by one-touch action (NFC).....	22
Playing with high quality sound codec (AAC/aptX).....	23

---

## Listening to music via a wireless network

Preparing: setting up for a network .....	24
Connecting with PC .....	24
Connecting with a wired network.....	25
Listening to music on an Xperia™/Xperia Tablet (WALKMAN® application) .....	26
Listening to music on iPhone, iPad, iPod or iTunes (AirPlay).....	27
Listening to music on Windows 8/Windows 7 (Home network).....	28
Using Internet music streaming (Music Services).....	29

---

## Additional information

Setting the Automatic Standby function .....	30
Setting the BLUETOOTH/Network Standby mode.....	31
Setting the wireless signal ON/OFF .....	31
Adjusting the sound .....	32
Using the timers .....	32
Setting the Sleep Timer.....	32
Setting the Play Timer.....	32
Updating the software .....	34

---

## About “SongPal” .....

35

---

## Troubleshooting

Troubleshooting .....	36
Messages .....	41

---

# Precautions/Specifications

Precautions .....	42
Compatible devices and versions .....	43
iPhone/iPad/iPod or iTunes .....	43
DLNA device .....	43
USB device .....	44
BLUETOOTH wireless technology.....	44
Specifications .....	46
Important information on software .....	50

# Location and Function of Controls

## Note

This manual mainly explains operations using the remote, but the same operations can also be performed using the buttons on the unit having the same or similar names.

## Unit (front)

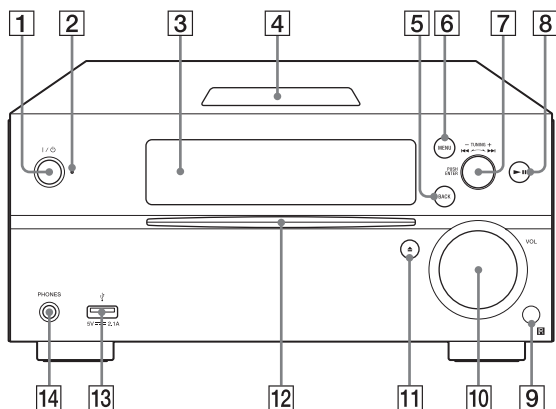

### 1 I/O (power) button

Use to turn the power on or off.

### 2 Standby indicator

Lights in yellow-green when the power is turned on. Lights in red when the power is turned off. The indicator flashes in red if the system detects an abnormality (page 36).

When the system in BLUETOOTH/Network Standby mode, the indicator lights up in orange.

### 3 Display window

#### 4 N-Mark

Place a smartphone/tablet equipped with the NFC function close to this mark to perform BLUETOOTH registration, connection or disconnection by a one-touch action (page 22).

### 5 BACK button

Use to go back to the previous display.

### 6 MENU button

Use to display the menu. Press ▲/▼ to select the items in the menu.

### 7 ◀▶ (previous/next) /TUNING +/- buttons

- Use to cue to the beginning of a track or file.
- Use to tune in a desired radio station.

#### PUSH ENTER button

Use to operate as the ENTER button.

### 8 ▶II (play/pause) button

Use to start or pause playback.

### 9 Remote sensor

### 10 VOL dial

Use to adjust the volume.

### 11 ▲ (eject) button

Use to eject a CD.

### 12 Disk slot

Insert a CD with the label side facing upward.

**13** **ψ (USB FRONT) port**  
Connect a USB device (page 16).

**14** **PHONES jack**  
Use to connect headphones.

## Remote

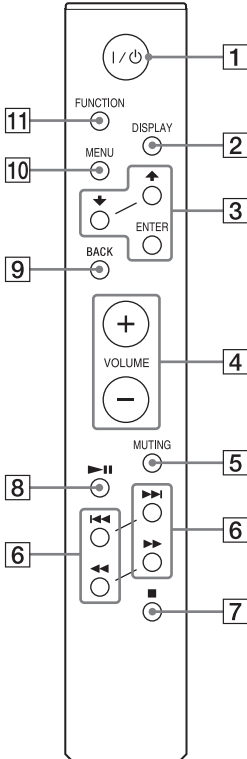

**1** **I/ψ (power) button**  
Use to turn the power on or off.

**2** **DISPLAY button**  
Use to change the information displayed in the display window when the power is on. An underscore “\_” is displayed in the place of an unrecognizable character. If you press this button when the power is turned off, the clock is displayed. However, if you press this button when the BLUETOOTH/Network Standby mode is on, the clock is not displayed.

**3** **▲/▼/ENTER button**  
Press ▲/▼ to select an item, then press ENTER to enter.  
Use ▲/▼ to select a folder (album) on an MP3 disc or USB device.

**4** **VOLUME +/- button**  
Use to adjust the volume.

**5** **MUTING button**  
Use to turn off the sound temporarily. Press the button again to restore the sound.

**6** **◀◀/▶▶ (previous/next, PRESET +/-) buttons**

- Use to cue to the beginning of a track or file.
- Use to select a preset number of the radio station tuned in.

**◀◀/▶▶ (fast-rewind/fast-forward, TUNING +/-) buttons**

- Use to fast-rewind or fast-forward a track or file.
- Use to tune-in a desired radio station.

**7** **■ (stop) button**  
Use to stop playback.

**8** **▶|| (play/pause) button**  
Use to start or pause playback.

**9** **BACK button**  
Use to return to the previous status.

**10** **MENU button**  
Use to display the menu. Press ▲/▼ to select the items in the menu.

**11** **FUNCTION button**  
Press to change the functions. Each press changes to the next function in the following sequence:  
CD → USB FRONT → USB REAR → BLUETOOTH → DAB → TUNER FM → TUNER AM → LINE IN → NETWORK



## Unit (back)

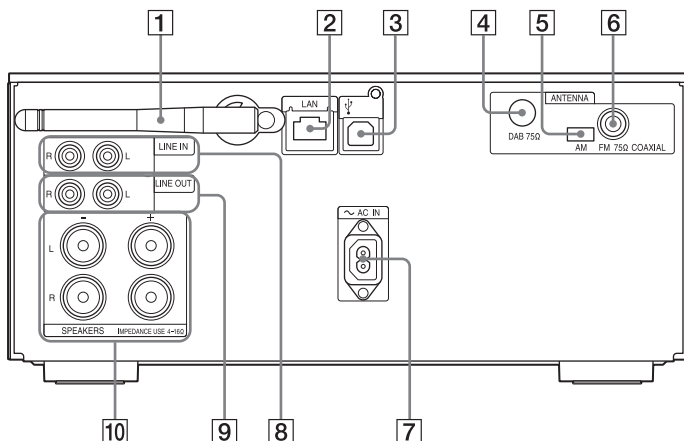

### 1 Wireless LAN antenna

If you use the wireless network function, set the antenna as shown in the illustration.

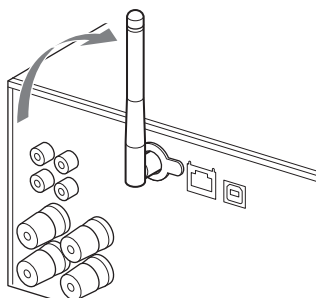

### 2 LAN connector

Connect network equipment with network cable (not supplied) (page 25).

### 3 USB REAR port

Connect a computer or WALKMAN® which is compatible with High-Resolution Audio. Use the USB cable (not supplied) (page 17). If you connect a WALKMAN® to the unit, use an optional High-Resolution Audio USB Adaptor WM-PORT Cable\* (not supplied) and the USB cable (not supplied).  
You can also use this as a USB-DAC.

\* Optional High-Resolution Audio USB Adaptor WM-PORT Cable can be ordered from your nearest Sony dealer.

### 4 DAB ANTENNA

Connect the DAB antenna.

### 5 AM ANTENNA

Connect the AM loop antenna.

### 6 FM ANTENNA

Connect the FM antenna.

#### Note

- Find a location and an orientation that provide good reception, and then fix the antennas to a stable surface (window, wall, etc.).
- Keep the antennas away from the unit, power cord and other AV components to avoid picking noise.
- Secure the end of the FM lead antenna with adhesive tape.

## To prepare the AM loop antenna

1 Fold the antenna stand as illustration.

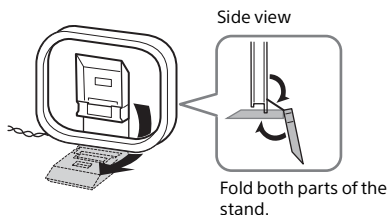

- 2 Attach the projecting part of the frame to the antenna stand.

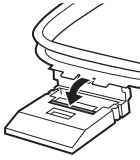

Press until it clicks.

- 7 **~ AC IN (220-230 V AC) input**  
Connect the power cord (supplied) to the wall outlet.
- 8 **LINE IN (external input) jack**  
Connect to an output jack of the optional external components with an audio connecting cable (not supplied).
- 9 **LINE OUT (external output) jack**  
Outputs the audio of the selected FUNCTION. Connects optional external components with an audio connecting cable (not supplied).
- 10 **SPEAKERS L/R (left/right) connectors**  
Connect each speaker.  
For details on connecting, see Quick Start Guide.

## Inserting the batteries

Insert two supplied R03 (size AAA) batteries, ⊖ side first, matching the polarities shown below.

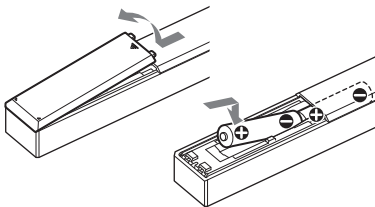

### Note

- With normal use, the batteries should last for about 6 months.
- Do not mix an old battery with a new one or mix different types of batteries.
- If you do not use the remote for a long period of time, remove the batteries to avoid damage from battery leakage and corrosion.

## Setting the clock

- 1 Press I/⏻ to turn on the system.
- 2 Press MENU.
- 3 Press ▲/▼ to select "Timer Menu," then press ENTER.  
If "Play Setting" is displayed, press ▲/▼ to select "Clock Setting," then press ENTER.
- 4 Press ▲/▼ to set the hour, then press ENTER.
- 5 Press ▲/▼ to set the minutes, then press ENTER.  
Complete the clock setting.

### Note

- The clock settings are reset when you disconnect the power cord or if a power failure occurs.

### To display the clock when the system is off

Press DISPLAY repeatedly to display the clock. The clock is displayed for about 8 seconds.

If the BLUETOOTH/Network Standby mode is on, the clock does not appear by pressing DISPLAY.

## Listening to a CD

# Playing a CD-DA/MP3 disc

1 Press **FUNCTION** to select "CD."

2 Insert a CD to the disc slot at the front of the unit.

Load a CD with the label side (printed side) facing up.

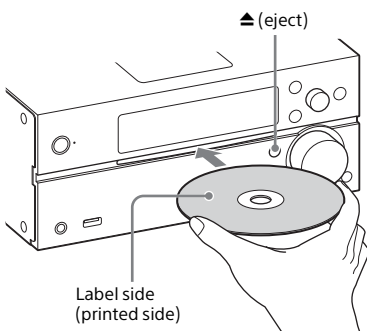

Plays back automatically.

If you switch the function to "CD" from another function when a CD is already inserted in the slot, press **▶▶** after "Reading" has disappeared from the display window.

The button of the remote or the unit enables you to fast-rewind/fast-forward, select a track, file or folder (for MP3 disc), etc.

## To eject the CD

Press **▲** (eject) on the unit.

### Note

- 8 cm CDs cannot be used with this system.
- Do not load a CD with non-standard shapes (e.g., heart, square, star). Doing this may cause irreparable damage to the system.
- Do not use a CD with tape, stickers or paste on it as this may cause malfunction.

- When you remove a disc, do not touch the surface of the disc.

## To change the play mode

Play mode enables you to playback the same music repeatedly or shuffle-play.

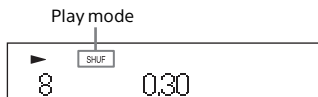

1 Press **■** to stop playback. If you select "Repeat" in step 4, you do not have to stop playback.

2 Press **MENU**.

3 Press **▲/▼** to select "CD Menu," then press **ENTER**.

4 Press **▲/▼** to select "Playmode" or "Repeat," then press **ENTER**.

5 Press **▲/▼** to select the play mode, then press **ENTER**.

You can select the following play modes.

### Playmode

Play mode	Effect
Normal	Plays a track or file.
Folder*	Plays all tracks in the selected folder. "FLDR" lights up in the display window.
Shuffle	Plays all tracks or files in random order. "SHUF" lights up in the display window.

Play mode	Effect
<b>Folder Shuffle*</b>	Plays all tracks or files in the selected folder in random order. "FLDR. SHUF" lights up in the display window.
<b>Program</b>	Plays the programmed tracks or files. "PGM" lights up in the display window. For details, see "Creating your own program (Program Play)" (page 13).

\* This play mode is applicable only for playing an MP3 disc.

## Repeat

Play mode	Effect
<b>All</b> (Repeat plays all tracks)	The system plays all tracks in a disc or folder repeatedly. "↺" lights up in the display window.
<b>One</b> (Repeat plays one track)	The system plays the selected track repeatedly. "↺ 1" lights up in the display window.
<b>Off</b>	Cancels repeat playback.

## Note on playing MP3 discs

- Do not save unnecessary folders or files on a disc that has MP3 files.
- Folders that have no MP3 files are not recognized on the system.
- The system can only play MP3 files that have a file extension of ".mp3." Even when file name has the ".mp3" file extension, if it is not an audio MP3 file, playing this file may generate a loud noise, which could cause damage of the system.
- The maximum number of MP3 folders and files compatible with this system is:
  - 999\* folders (including the root folder)
  - 999 files
  - 250 files in a single folder
  - 8 folder levels (in the tree structure of files)

\* This includes folders that have no MP3 or other files. The number of folders that the system can recognize may be less than actual number of folders, depending on the folder structure.
- Compatibility with all MP3 encoding/writing software, CD-R/RW drive and

recording media cannot be guaranteed. Incompatible MP3 discs may produce noise or interrupted audio or may not play at all.

---

# Creating your own program (Program Play)

Plays the programmed track or file in a CD.

---

**1** Select "Program" in step 5 of "To change the play mode" (page 11), then press ENTER.

---

**2** When using an MP3 disc, press  $\uparrow/\downarrow$  to select the folder containing the tracks or files that you want to program.

If you want to play all tracks or files in the folder, press ENTER.

---

**3** Press  $\lll/\ggg$  to select a desired track or file, then select ENTER.

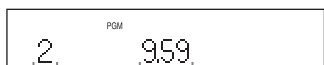

Selected track or file number

Total playing time of the selected track or file

Repeat the steps above to program additional tracks or files.

---

**4** Press  $\ggg$ .  
Your program of tracks or files starts playback.

## To cancel program play

In step 1, select "Normal" for "Program," then press ENTER.

## To delete a programmed track, file or folder

Press  $\blacksquare$  while the play is stopped. Each time you press the button, the last programmed track, file or folder will be deleted.

When all the programmed tracks, files or folders are deleted, "No Step" appears.

### Tip

- Up to 25 tracks, files or folders can be programmed. If you attempt to program more than 25 tracks, files or folders, "Step Full!" will be displayed. In this case, delete unnecessary tracks.
- To play the same program again, press  $\ggg$ .

### Note

- When the disc is ejected or the power cord is disconnected after programming, all the programmed tracks, files and folders are deleted.

## Tuning in a radio station

1 Press FUNCTION to select "DAB," "TUNER FM" or "TUNER AM."

2 Press and hold ◀▶ until the frequency indication in the display window starts changing, then release the button.

Tuning stops automatically when a radio station is tuned in (**Automatic Scanning**), and "STEREO" (when a FM stereo broadcast is received) appears in the display.

### Manual tuning

Press ◀▶ repeatedly to tune-in the desired station.

### Note on DAB/DAB+ stations

- When you tune in a station that provides RDS services, information such as the service name or station name is provided by broadcasts.
- When tuning in a DAB/DAB+ station, it may take a few seconds before you hear any sound.
- Primary service is automatically received when secondary service ends.
- This tuner does not support data services.

#### Tip

- If reception of an FM stereo broadcast is noisy, press MENU and select "Tuner Menu," "FM Mode" and "Mono" in turn, to select monaural reception. This reduces noise.

### To change the AM tuning interval

The default setting for AM tuning interval is 9 kHz (or 10 kHz for some areas). Use the buttons on the unit to perform this operation.

- 1 Press FUNCTION on the unit repeatedly to select "TUNER AM."
- 2 Press I/⏻ to turn off the unit.
- 3 Press and hold MENU and press I/⏻ on the unit.

"Step 9k" or "Step 10k" appears in the display. When you change the interval, all the AM preset stations are erased.

# Presetting radio stations

You can preset your desired radio stations.

**1** Tune in the desired station, then press MENU.

**2** Press  $\uparrow/\downarrow$  to select "Tuner Menu," then press ENTER.  
To preset an AM station, select "AM Preset Memory" and follow step 4.

**3** Press  $\uparrow/\downarrow$  to select "FM Preset Memory" (for FM stations) or "DAB Preset Memory" (for DAB stations), then press ENTER.

**4** Press  $\uparrow/\downarrow$  to select "Ok," then press ENTER.

**5** Press  $\uparrow/\downarrow$  to select preset number, then press ENTER.

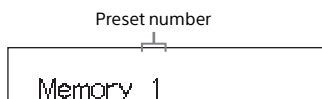

"Complete!" appears in the display window and the radio station is registered with the preset number. Repeat the steps above to register further radio stations.

**6** Press  $I/\text{power}$  to turn off the power, then press  $I/\text{power}$  again to turn on the power.

## Tip

- You can preset up to 20 FM, 20 DAB/DAB+, and 10 AM stations.

- If you select an already-registered preset number in step 5, the preset radio station is replaced by the currently tuned-in radio station.

## To tune in to a preset radio station

Press  $\lll/\ggg$  to select the preset number to which the desired station is registered.

## Running the DAB Automatic Scan manually

Before you can tune in DAB/DAB+ stations, you must perform a DAB Initial Scan. When you have moved to another area, also perform the DAB Initial Scan manually to update the DAB/DAB+ service information.

**1** Press MENU.

**2** Press  $\uparrow/\downarrow$  to select "Tuner Menu," then press ENTER.

**3** Press  $\uparrow/\downarrow$  to select "Initial Scan," then press ENTER.

**4** Press  $\uparrow/\downarrow$  to select "Ok," then press ENTER.

Scanning begins. The scanning progress is indicated by asterisks (\*\*\*\*\*). Depending on the DAB/DAB+ services available in your area, scanning may take a few minutes.

## Note

- If your country or region does not support DAB/DAB+ broadcast, "No Service" appears.
- This procedure clears all previously stored presets.
- Before unplugging the DAB/FM lead antenna, make sure the system is turned off to preserve your own DAB/DAB+ settings.

## Listening to a file on a USB device

# Playing a file on a USB device

You can play audio files stored on a USB device such as WALKMAN® or digital media player, on this system by connecting a USB device to the system.

The  $\Psi$  (USB REAR) port on the rear of the unit can be connected with a computer or WALKMAN® which is compatible with High-Resolution Audio.

For details on compatible USB devices, see “Compatible devices and versions” (page 43).

### Note

- If you play back High-Resolution Audio, use the device which is compatible with USB2.0 High Speed cable.

## Connecting a USB device to the USB port on the front of the unit

**1** Press FUNCTION to select “USB FRONT.”

**2** Connect a USB device to the  $\Psi$  (USB FRONT) port on the front of the unit.

When connecting the USB device, connect it directly, or via the USB cable supplied with the USB device. Wait until “Reading” disappears and “ROOT” appears.

**3** Press **▶||**.

Starts playback.

Operate with the button of the remote or unit.

You can select a track, file or folder by pressing ENTER, while “ROOT” is appearing.

### Tip

- When playing the USB device, the play mode can be selected. Press MENU, then select “USB Menu.” Select “Playmode” or “Repeat.” For details, see “To change the play mode” (page 11). When a file on a USB device is playing, a track or file in the folder, shuffle-playback or programmed playback cannot be played.
- Charging begins automatically when you connect the USB device to the  $\Psi$  (USB FRONT) port of the unit. When the system is turned off, the USB device does not charge.
- If the USB device cannot be charged, disconnect and reconnect it. For details on the charging status of the USB device, see the operating manual of the USB device.

### Note

- The playback order for the system may differ from the playback order of the connected digital music player.
- Be sure to turn off the system before removing the USB device. Removing the USB device while the system is turned on may corrupt the data on the USB device.
- When USB cable connection is necessary, connect the USB cable supplied with the USB device to be connected. For details on connection, refer to the operation manual supplied with the USB device to be connected.
- It may take time before “Reading” appears after connecting, depending on the type of USB device connected.
- Do not connect the USB device through a USB hub.
- When the USB device is connected, the system reads all the files on the USB device. If there are many folders or files on the USB device, it may take a long time to finish reading the USB device.
- With some connected USB devices, it may take a long time to transmit signals from the system or to finish reading the USB device.
- When the unit is connected to a wired network, depending on the router or network connection conditions, the USB function may be temporarily disabled. In this case, wait for a while, then connect the unit to the network again.
- Compatibility with all encoding/writing software cannot be guaranteed. If audio files on the USB device were originally encoded with incompatible software, those files may produce noise or may malfunction.



- The maximum number of folders and files on the USB device compatible with this system is:
  - 998\*<sup>1</sup> folders (including the root folder)
  - 998 files in a single folder
  - 8 folder levels (in the tree structure of files)
- \*<sup>1</sup> This includes folders that have no playable audio files and empty folders. The number of folders that the system can recognize may be less than actual number of folders, depending on the folder structure.
- The system does not necessarily support all the functions provided in a connected USB device.
- Folders that have no audio files are not recognized.

## Connecting a USB device to the USB port on the rear of the unit

To listen to High-Resolution Audio from your computer, install the dedicated driver\* to your computer.

\* For Mac OS, a driver is not required.

- 1 Download the driver from the website below;  
For customers in Europe:  
<http://support.sony-europe.com/>  
For customers in other countries/  
regions:  
<http://www.sony-asia.com/support>

- 2 Install the driver.  
Follow the procedure on the website.

- 3 Press FUNCTION to select "USB REAR."

- 4 Connect a computer or WALKMAN® which is compatible with High-Resolution Audio, etc., to the  $\Psi$  (USB REAR) port on the rear of the unit.

Operate playback by the computer or WALKMAN® which is compatible with High-Resolution Audio. For details, see the operating instructions of your computer or WALKMAN®.

### Note

- If you connect a WALKMAN® to this port, use the USB cable (not supplied) and an optional High-Resolution Audio USB Adaptor WM-PORT Cable\*<sup>2</sup> (not supplied).
- If you play back High-Resolution Audio by connecting your computer, "Hi-Res Audio Player" (for Windows/Mac OS) is recommended. The player can be downloaded for free;

For customers in Europe:

<http://support.sony-europe.com/>

For customers in other countries/regions:

<http://www.sony-asia.com/support>

- The USB device cannot be charged from the  $\Psi$  (USB REAR) port.
- \*<sup>2</sup> Optional High-Resolution Audio USB Adaptor WM-PORT Cable can be ordered from your nearest Sony dealer.

## Playable audio formats

The audio formats that you can listen to with this system are as follows:

- MP3: file extension ".mp3"
- WMA\*<sup>3</sup>: file extension ".wma"
- AAC\*<sup>3</sup>: file extension ".m4a," ".mp4" or ".3gp"
- WAV: file extension ".wav"
- FLAC: file extension ".flac"
- ALAC: file extension ".m4a"
- AIFF: file extension ".aiff," ".aif" or ".aifc"
- DSD: file extension ".dsf"
- DSDIFF: file extension ".dff"

Note that even when file name has the correct file extension, if the actual file differs, the system may produce noise or may malfunction.

- \*<sup>3</sup> Files with DRM (Digital Rights Management) copyright protection or files downloaded from an online music store cannot be played on this system. If you try to play one of these files, the system plays the next unprotected audio file.

## Listening to music of an iPhone/iPad/iPod

# Playing an iPhone/iPad/iPod connected by USB

You can play an iPhone/iPad/iPod by connecting it to the  $\Psi$  (USB FRONT) port in the front of the unit.

For details on compatible iPhone/iPad/iPod, see "Compatible devices and versions" (page 43).

- 1 Press FUNCTION to select "USB FRONT."
- 2 Connect an iPhone/iPad/iPod to  $\Psi$  (USB FRONT) port on the front of the unit using the cable supplied with the iPhone/iPad/iPod.  
Before connecting an iPhone/iPad/iPod, connect the USB cable to the unit. The display changes from "USB" to "iPod".

- 3 Press **▶II**.  
Starts playback.  
You can fast-rewind/fast-forward the track or select the track using buttons on the remote or the unit.

### Tip

- Charging begins automatically when you connect an iPhone/iPad/iPod to the system. When the system is turned off, the iPhone/iPad/iPod does not charge.
- If an iPhone/iPad/iPod cannot be charged, disconnect and reconnect it. For details on the charging status of an iPhone/iPad/iPod, see the operating manual of an iPhone/iPad/iPod.

### Note

- Before disconnecting the iPhone/iPad/iPod, turn off the system. If you disconnect it when the system is on, the data stored on the iPhone/iPad/iPod may be corrupted.
- Do not carry the system with an iPhone/iPad/iPod connected to the system. Doing so may cause a malfunction.
- To use an iPhone/iPad/iPod, refer to the user's guide of your iPhone/iPad/iPod.
- Sony cannot accept responsibility in the event that data recorded to iPhone/iPad/iPod is lost or damaged when using an iPhone/iPad/iPod with this system.

# Playing back an iPhone/iPad/iPod over a wireless connection (AirPlay)

You can play back an iPhone/iPad/iPod touch or the computer with iTunes over a wireless connection. For details, see "Listening to music on iPhone, iPad, iPod or iTunes (AirPlay)" (page 27).

# Playing back the music of connected components

You can listen to a track of connected components through external output connected to the unit.

**Note**

- Beforehand, press the VOLUME - to turn down the volume.

- 
- 1** Press FUNCTION to select "LINE IN."
- 
- 2** Connect its audio connecting cord to the LINE IN (external input) jack on the rear of the unit and the output terminal of the optional external equipment.
- 
- 3** Start playback of the connected component.  
Adjust the volume on the connected component during playback.
- 
- 4** Press VOLUME +/- on the remote to adjust the volume.

**Note**

- The system may enter Standby mode automatically if the volume level of the connected component is too low. For details, see "Setting the Automatic Standby function" (page 30).

## Listening to music through a BLUETOOTH connection

# Pairing the system with a BLUETOOTH device and listening to music

You can listen to music from BLUETOOTH device over a wireless connection. Before using the BLUETOOTH function, perform pairing to register your BLUETOOTH device.

### Note

- Place the BLUETOOTH device to be connected within one meter of the system.
- If your BLUETOOTH device is compliant with touch (NFC), skip the next procedure. See "Listening to music by one-touch action (NFC)" (page 22).

---

**1** Press FUNCTION to select "BLUETOOTH."

---

**2** Press MENU.

---

**3** Press  $\blacktriangle/\blacktriangledown$  to select "Bluetooth Menu," then press ENTER.

---

**4** Press  $\blacktriangle/\blacktriangledown$  to select "Pairing," then press ENTER.

---

**5** Press  $\blacktriangle/\blacktriangledown$  to select "Ok" then press ENTER.

When "Pairing" starts flashing in the display window, the system changes to pairing mode.

---

**6** Search for this system with the BLUETOOTH device.

A list of the devices found may appear on the BLUETOOTH device display.

---

**7** Select [SONY:MAP-S1] (this system).

If prompted to enter a passkey on the BLUETOOTH device, enter "0000."

If this system is not shown in the display window of the device, proceed from step 1 again.

When pairing is completed, the display changes to the connected BLUETOOTH from "Pairing" and the device name is displayed.

---

**8** Press  $\blacktriangleright\parallel$ .

Starts playback.

Depending on the BLUETOOTH device, press  $\blacktriangleright\parallel$  again. Also, you may have to start up a music player on the BLUETOOTH device.

---

**9** Press VOLUME +/- to adjust the volume.

If the volume cannot be changed on the system, adjust it on your BLUETOOTH device.

Operation such as fast-rewind/fast-forward, selecting music and selecting a folder can be operated with the remote or buttons of the unit.

### Tip

- You can perform a pairing operation or attempt to make a BLUETOOTH connection with another BLUETOOTH device while the BLUETOOTH connection is established with one BLUETOOTH device. The currently established BLUETOOTH connection is canceled when BLUETOOTH connection with another device is successfully established.

### Note

- The operations described above may not be available for certain BLUETOOTH devices. In addition, the actual operations may differ depending on the connected BLUETOOTH device.

- Once a pairing operation is performed, it does not have to be performed again. In the following cases, however, a pairing operation must be performed again:
  - Pairing information was erased when the BLUETOOTH device was repaired.
  - You attempt to pair the system with more than 9 BLUETOOTH devices.  
This system can pair with up to 9 BLUETOOTH devices. If you pair another BLUETOOTH device after pairing with 9 devices was performed, pairing information of the device that was connected with the system first is overwritten with that of the new device.
  - Pairing registration information of this system is erased from the connected device.
  - If you initialize the system or erase the pairing history with the system, all the pairing information will be erased.
- The sound of this system cannot be sent to a BLUETOOTH speaker.
- “Passkey” may be called “Passcode,” “PIN code,” “PIN number” or “Password,” etc.

### To check the address of a connected BLUETOOTH device

Press DISPLAY while the name set on the connected BLUETOOTH device is shown in the display window. The BLUETOOTH device address appears in the display window for about 8 seconds.

### To cancel the connection with the BLUETOOTH device

Disconnect the BLUETOOTH connection on the BLUETOOTH device. “BLUETOOTH” appears in the display window. Depending on the device, the connection may be canceled automatically when you stop playback.

### To erase the pairing registration information

- 1 Select “Delete Link” after step 3 on “Pairing the system with a BLUETOOTH device and listening to music” (page 20), then press ENTER.
- 2 Press  $\blacktriangle/\blacktriangledown$  to select “Ok,” then press ENTER.  
“Complete!” appears in the display window and all the pairing information is erased.

#### Note

- If you have erased the pairing information, you cannot make a BLUETOOTH connection unless pairing is performed again.

## Listening to music through a registered device

After step 1 on “Pairing the system with a BLUETOOTH device and listening to music,” operate the BLUETOOTH device to connect with the system, then press  $\blacktriangleright\|\blacktriangleleft$  of the unit to start playback.

---

# Listening to music by one-touch action (NFC)

NFC is a technology for short-range wireless communication between various devices such as a mobile phone and IC tag. Just touch your smartphone/tablet on the system. The system is turned on automatically, and pairing and BLUETOOTH connection are established. Beforehand, turn the NFC settings to on.



- When you touch an NFC-compliant smartphone/tablet on the unit while another BLUETOOTH device is connected with this system, the BLUETOOTH device is disconnected and the system is connected with the smartphone/tablet.

#### Note

- In some countries and regions, NFC-compliant application may not be downloaded.

---

## 1 Touch your smartphone/tablet on the N-mark on the unit.

Touch the smartphone/tablet on the unit and maintain contact until the smartphone/tablet vibrates. Refer to the user's guide of your smartphone/tablet for the part of your smartphone/tablet used as touch contact.

---

## 2 After completing the connection, press ►||.

Starts playback.

To disconnect the established connection, touch your smartphone/tablet on the N-Mark on the unit.

#### Tip

- Compatible smartphones are those equipped with the NFC function (compatible operating system: Android version 2.3.3 or later with the exception of Android 3.x). Check the website below for information on compatible devices.

For customers in Europe:

<http://support.sony-europe.com/>

For customers in other countries/regions:

<http://www.sony-asia.com/support>

- If the smartphone/tablet does not respond even though it is touched to the unit, download "NFC Easy Connect" to your smartphone/tablet and run it. Then touch to the unit again. "NFC Easy Connect" is a free application for exclusive use with Android™. Scan the following 2D Code.

---

# Playing with high quality sound codec (AAC/aptX)

You can receive the data in AAC or aptX codec format from a BLUETOOTH device. It provides the playback with a higher quality sound.

The factory settings of "Bluetooth AAC" and "Bluetooth aptX" are "On."

- 
- 1 Press MENU.

---

  - 2 Press  $\uparrow/\downarrow$  to select "Bluetooth Menu," then press ENTER.

---

  - 3 Press  $\uparrow/\downarrow$  to select "Bluetooth AAC" (AAC codec) or "Bluetooth aptX" (aptX codec), then press ENTER.

---

  - 4 Press  $\uparrow/\downarrow$  to select "On," then press ENTER.

**Note**

- If you initiate setup during BLUETOOTH connection, the connection is cut.
- If sound is interrupted during reception in AAC codec format, set to "Off" in step 4 to cancel the settings. In this case, the system receives SBC codec.

## Listening to music via a wireless network

# Preparing: setting up for a network

If you connect this system to a network, you can enjoy this system in various ways. Depending on your network environment, setting up methods are different. Check your network environment beforehand.

### Tip

- For setting the fixed IP address, use the screen in step 6 of “Connecting with PC” (page 24).

### Note

- Connecting to the wireless network and the wired network simultaneously is not possible. When you connect to the wireless network, be sure to disconnect the network (LAN) cable from the system.
- When setting up a wireless network, SSID (Wireless Network Name) and Security Key (WEP or WPA key) may be required. The security key (or network key) uses encryption to limit the devices with which communication can occur. It is used to provide higher security for devices communicating via a wireless LAN router/access point.

## Method for using smartphone/tablet

Use the SongPal application for exclusive use with a smartphone/tablet. For details, see Quick Start Guide.

## Method for using the access point supporting WPS

Using the WPS access button to connect. See Quick Start Guide.

## Method for using PC

See “Connecting with PC” (page 24).

## Method for using wired network

See “Connecting with a wired network” (page 25).

## Connecting with PC

### Note

- Be aware that your Wi-Fi network will not be protected until the setting is complete. After the setting is complete, your Wi-Fi network will be protected again when you set a wireless LAN security.

- 1 Have the wireless network name (SSID) and Security Key of the wireless LAN router/access point to be used available for reference.

SSID (Wireless Network Name)

---

Security Key (WEP or WPA)



---

For the SSID and Security Key, refer to the operating instructions of the wireless LAN router/access point.

- 2 Press I/⏻ to turn on the system.



- 3 Connect the unit to a Mac or PC.

### For Windows 8 (Windows UI)

- ① Turn on PC.
- ② Move the mouse pointer to the top-right (or bottom-right) corner on the Start screen to display the charms, and select [Settings].  
With a touch panel, display the charms by swiping from the right end of the Start screen, and select [Settings].
- ③ Select or tap the  or  icon.
- ④ Select [Sony\_Wireless\_Audio\_Setup] from the network list.



### For Windows 8/Windows 7

- 1 Turn on PC.
- 2 Click or tap the desktop on the Start screen.
- 3 Select the  or  icon on the bottom of the screen.
- 4 Select [Sony\_Wireless\_Audio\_Setup] from the network list.

### For Windows Vista

- 1 Turn on PC.
- 2 Click the  icon on the bottom of the screen.
- 3 Select [Connect to a network].
- 4 Select [Sony\_Wireless\_Audio\_Setup] from the network list.

### For Mac OS X

- 1 Turn on Mac.
- 2 Select the  icon on the top of the screen.
- 3 Select [Sony\_Wireless\_Audio\_Setup] from the network list.

## 4 Access the [Sony Network Device Setting] screen.

### For PC

Start the browser and input either of the following URLs into the browser's address bar.

<http://192.168.100.1>

### For Mac

Start Safari and select [Bonjour] under  ([Bookmarks]), then select [SONY:MAP-S1].

## 5 Select the desired language when the [Language Setup] screen appears.

## 6 Select [Network Settings] from the menu.



Network Settings

## 7 Select the SSID of the wireless LAN router/access point, then select [Apply].

If necessary, input the security key.

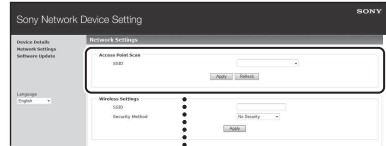

SSID

When the confirmation screen displays, press [OK].

## 8 Press I/⏻ to turn off the power, then press I/⏻ again to turn on the power.

## 9 Connect the Mac or PC to the wireless LAN router/access point to be used.

### Note

- This procedure needs to be completed within 10 minutes. If you cannot complete, reset your computer (page 40).

## Connecting with a wired network

Usually, the DHCP setting is set to ON when you connect your computer to the network. For details, refer to the manual of your computer.

## 1 Check whether your computer and router are turned on.

## 2 Connect the system and the router using a network (LAN) cable (not supplied).

---

**3** Connect the router and your computer using a second network (LAN) cable (not supplied) or a wireless LAN connection.

---

**4** Turn the system on.  
 lights up in the display window when the connection is made.

---

## Listening to music on an Xperia™/Xperia Tablet (WALKMAN® application)

Using the WALKMAN® application, you can play music stored in an Xperia device (Xperia/Xperia tablet).

**Note**

- Make sure that the Xperia device is connected to the network beforehand, and update its Android OS to the latest version before using it with this system.

---

**1** Connect the system to the network.  
For details, see “Preparing: setting up for a network” (page 24).

---

**2** Launch the WALKMAN® application on the Xperia device.

---

**3** Select the  icon at the upper right on the Xperia device.  
The list of the devices which can be connected with the system are displayed.

---

**4** Select [SONY:MAP-S1] (this system).

---

**5** Start playing back audio content on the Xperia device.  
The system enters the “Home Network” function mode and the selected audio content is played back. If playback does not start, perform the procedure again from step 1.

**Tip**

- Refer to the operating manual of your Xperia device for details.
- For details on the use of the Android OS, refer to Help of Android OS.
- This system can play back music stored in some WALKMAN® models using the Music Throw function. For details on the Music Throw function, refer to the operation manual supplied with your WALKMAN®.

---

## Listening to music on iPhone, iPad, iPod or iTunes (AirPlay)

Using AirPlay, you can play music stored in iPhone, iPad, iPod touch or in a Mac or computer equipped with iTunes.

For details on the compatible iPhone, iPad, iPod touch or iTunes, see “Compatible devices and versions” (page 43).

**Note**

- Connect an iPhone/iPad/iPod touch or computer equipped with iTunes to the network, and update iOS or iTunes to the latest version before using with this system.

---

### 1 Connect the system to the network.

For details, see “Preparing: setting up for a network” (page 24).

---

### 2 Launch the application of your iPhone, iPad, iPod touch, or iTunes.

---

### 3 Select the icon of the control center of the iPhone, iPad or iPod touch screen or iTunes window.

The list of the devices which can be connected with the system are displayed.

---

### 4 Select [SONY:MAP-S1] (this system).

## 5 Start playing back audio content on an iPhone, iPad, iPod touch or iTunes.

The system enters the AirPlay function mode and the selected audio content is played back.

If the playback does not start, perform the process again from step 1.

### Tip

- Very loud sound may output from this system when you set the volume too high using iPhone, iPad, iPod touch or iTunes.
- The volume level of iPhone, iPad, iPod touch or iTunes may not be able to be linked with the volume level of this system.
- Refer to the operating manual of your device for details on operating iPhone, iPad, iPod touch, iTunes or AirPlay.

# Listening to music on Windows 8/ Windows 7 (Home network)

You can play back tracks on home network servers such as the computer application Media Go, Windows Media Player, etc., on this system. For details, see the website below.

For customers in Europe:

<http://support.sony-europe.com/>

For customers in other countries/regions:

<http://www.sony-asia.com/support>

You can use a smartphone/tablet as a controller with the SongPal application for exclusive use with your smartphone/tablet. For information on compatible DLNA devices, see "Compatible devices and versions" (page 43).

### Tip

- To play music from a computer equipped with Windows Vista, a controller is needed for the operation. For details, see operating manual of your computer.

### Note

- The system can play audio content stored on the server in MP3, Linear PCM, WMA, AAC, WAV, FLAC, ALAC and AIFF audio formats. (The system can play AAC files with the extension of ".m4a," ".mp4," or ".3gp" only.)  
When using a wireless connection, the system may not play back some audio files.
- This system cannot play back files in WMA format with DRM copyright protection. If a WMA file cannot be played back on this system, right-click the file on your computer. If there is a "License" tab, the file is protected by DRM.
- Generally, it may take a while to recognize each DLNA-compliant device currently used when you enjoy audio content via a home network.
- You may not be able to play back some content with DLNA CERTIFIED products.

---

# Using Internet music streaming (Music Services)

You can use various Internet music streaming offered on the Internet, using SongPal installed on a smartphone/tablet as the controller without using a computer.

Depending on the smartphone/tablet, the following operation may differ. For details, refer to the operating manual of your smartphone/tablet.

---

## 1 Download SongPal to the smartphone/tablet, then run SongPal.

SongPal is an application for exclusive use with a smartphone/tablet. A dedicated App for this model is available on both Google Play™ and the App Store and install it following the instructions displayed on the smartphone/tablet.

---

## 2 Follow the instructions displayed on the smartphone/tablet, connect the system to the network.

For details, see Quick Start Guide.

---

## 3 Select a music service from the source list of SongPal.

The selected music service starts. Then a list of playable music is displayed.

---

## 4 Select the desired playable content and start playback.

Select the playable music.

When playback starts, the selected music service appears in the display window.

If playback does not start, perform the process again from step 3.

### Tip

- You have to register your system in order to use Music Unlimited. For details on registration, refer to the following website (Oceania model only): <http://munlimited.com/home>
- Depending on the service, you have to enter your ID and password when logging in. To delete your ID and password, reset the unit (page 40).
- Very loud sound may output from this unit when you set the volume too high using an smartphone/tablet or iOS.
- For details on the use of the Android OS or iOS, refer to Help of each OS.
- For details on the use of "SongPal," tap/click on the Help icon or Option icon of it.

### Note

- Depending on the country and regions, services and the period of availability may differ. A separate registration is required for certain services. An upgrade of the device may be required.

- when a USB device is connected in USB function
- when a button on the remote or unit is pressed

# Setting the Automatic Standby function

The system enters Standby mode automatically in about 15 minutes when there is no operation or audio signal output (Automatic Standby function). By default, the Automatic Standby function is turned on.

- 1 Press MENU.
- 2 Press  $\blacktriangle/\blacktriangledown$  to select "Standby Mode Menu," then press ENTER.
- 3 Press  $\blacktriangle/\blacktriangledown$  to select "Auto Standby," then press ENTER.
- 4 Press  $\blacktriangle/\blacktriangledown$  to select "On" or "Off," then press ENTER.

**Tip**

- 2 minutes before entering Standby mode, "Auto Standby" displays in the display window.

**Note**

- The Automatic Standby function is invalid for the tuner function (FM/AM/DAB), even when you have enabled it.
- The system may not enter Standby mode automatically in the following cases:
  - while using the FM, AM or DAB function.
  - while an audio signal is being detected
  - during playback of audio tracks or files
  - while the Play Timer or Sleep Timer is being used
- The system counts down the time (about 15 minutes) again until it enters Standby mode, even when Automatic Standby function is enabled in the following cases:

# Setting the BLUETOOTH/Network Standby mode

When BLUETOOTH/Network Standby mode is enabled, the system enters Wait mode for BLUETOOTH or network connection even when the system is turned off. This mode is disabled by default.

- 1 Press MENU.
- 2 Press  $\blacktriangle/\blacktriangledown$  to select "Standby Mode Menu," then press ENTER.
- 3 Press  $\blacktriangle/\blacktriangledown$  to select "BT/NW Standby," then press ENTER.
- 4 Press  $\blacktriangle/\blacktriangledown$  to select "On" or "Off," then press ENTER.
- 5 Press  $I/\text{power}$  to turn off the system.

#### Tip

- When this function is set to "ON" and you connect to the system from a BLUETOOTH or AirPlay device, the system turns on automatically and you can listen to music by using the BLUETOOTH or AirPlay connection.

#### Note

- The system cannot be turned on by a DLNA device or by using a Music Services connection.

# Setting the wireless signal ON/OFF

When the unit is turned on, you can control a wireless network or BLUETOOTH signal. The default setting is ON.

- 1 Turn on the unit.
- 2 If  $\text{RF}$  flashes in the display window, press and hold PUSH ENTER and MENU of the unit.
- 3 After "RF Off" (wireless signal is off) or "RF On" (wireless signal is on) appears, release the button.

#### Tip

- When this setting is set to off, the wireless network function and BLUETOOTH function are not available.
- When this setting is off, the unit is turned on by the smartphone/tablet by one-touch action (NFC) on the unit.
- When this setting is off, the BLUETOOTH/Network Standby mode cannot be set.
- When the BLUETOOTH/Network Standby mode is on and the unit is turned off, the BLUETOOTH/Network Standby mode turns off.
- When this setting is off, the unit and BLUETOOTH device cannot be paired.
- Even when this setting is off, a wired connection can still be used.

---

# Adjusting the sound

Adjusts the sound to your preference. Selecting "DSEE HX" produces better quality sound of a compressed file, such as MP3.

---

- 1 Press MENU.
- 2 Press  $\uparrow/\downarrow$  to select "Sound Menu," then press ENTER.
- 3 Press  $\uparrow/\downarrow$  to select "BASS," "TREBLE," or "DSEE HX," then press ENTER.  
**BASS:** Adjusts the bass sound.  
**TREBLE:** Adjusts the treble sound.  
**DSEE HX:** Upgrades the sound quality better than CD or MP3. Complements the treble of a compressed file, such as MP3, and upgrades to a higher level of sampling frequency and number of bits from its original numeric. Select to "Auto." (The default setting is "Auto.")

---

# Using the timers

The system offers Sleep Timer and Play Timer.

## Note

- The Sleep Timer has priority over the Play Timer.

---

## Setting the Sleep Timer

At the specified time, the system is turned off automatically.

---

- 1 Press MENU.
- 2 Press  $\uparrow/\downarrow$  to select "Sleep Menu," then press ENTER.
- 3 Press  $\uparrow/\downarrow$  to select the specified time, then press ENTER.  
You can select from "10minutes" (10 minutes) to "90minutes" (90 minutes) in 10-minute increments.

## Tip

- To check the remaining time of Sleep Timer, perform steps 1 and 2 above.
- The Sleep Timer works even if the clock is not set.

## To cancel the Sleep Timer

Select "Off" in step 3 above.

---

## Setting the Play Timer

## Note

- Make sure you have set the clock before setting the timer (page 10).

## Play Timer

You can listen to a CD, USB device or radio every day at a preset time.

The Play Timer setting remains as long as the setting is not canceled.



- 
- 1 Prepare the sound source.

---

  - 2 Press MENU.

---

  - 3 Press  $\blacktriangle/\blacktriangledown$  to select "Timer Menu," then press ENTER.

---

  - 4 Press  $\blacktriangle/\blacktriangledown$  to select "Play Setting," then press ENTER.  
The start time flashes in the display window.

---

  - 5 Press  $\blacktriangle/\blacktriangledown$  to select time, then press ENTER.  
Follow the same procedure to set "Minute" of the time to start operation, then "Hour" and "Minute" of the time to stop the operation.

---

  - 6 Press  $\blacktriangle/\blacktriangledown$  to select the desired sound source, then press ENTER.  
The confirmation display for the Play Timer appears.

---

  - 7 Press  $I/\text{O}$  to turn off the system.

**Tip**

- When the sound source is a CD, you can preprogram the Play Timer. See "Creating your own program (Program Play)" (page 13).
- When the sound source is radio, make sure to tune-in the radio station in advance (page 14).
- To change the timer setting, perform the procedures from the beginning again.

**Note**

- The Play Timer does not work if the system is already on at the preset time. Turn off the unit about 5 minutes before the preset time. Be careful not to operate the system until it is turned on and starts play with the timer.
- When the sound source for a Play Timer is set to a radio station that you set using Automatic Scanning (AUTO) or Manual Tuning (MANUAL),

and you change the radio frequency or band after setting the timer, the radio station setting for the timer will also be changed.

- When the sound source for a Play Timer is set to a radio station tuned from a preset radio station, and you change the frequency of the radio station or band after setting the timer, the radio station setting for the timer will not change. The radio station tuning for the timer is fixed at the frequency you set.

### To check the setting

- 1 Press MENU.
- 2 Press  $\blacktriangle/\blacktriangledown$  to select "Timer Menu" then press ENTER.
- 3 Press  $\blacktriangle/\blacktriangledown$  to select "Timer Select," and then press ENTER.
- 4 Press  $\blacktriangle/\blacktriangledown$  to select "Play Setting," and then press ENTER.  
The timer setting appears in the display window.

### To cancel the timer

After step 3 on "To check the setting" (page 33), select "Timer Off," then press ENTER.

---

# Updating the software

When a new software version is detected, this system is updated when it is connected to the internet, and "UPDATE" appears in the display window.

In this case, follow the procedures below to update to the latest version.

---

**1** Press MENU.

---

**2** Press  $\blacktriangle/\blacktriangledown$  to select "Network Menu," then press ENTER.

---

**3** Press  $\blacktriangle/\blacktriangledown$  to select "Update," then press ENTER.

---

**4** Press  $\blacktriangle/\blacktriangledown$  to select "Ok," then press ENTER.

Starts downloading the latest software version.

After completing the download, updating begins.

Do not operate by the unit or the remote while the standby indicator lights in orange.

After completing the update, "Complete!" is displayed. Press  $\mathbf{I}/\text{⏻}$  to turn off the unit, and then press it again to turn on.

## Note

- Usually it may take about 3 to 10 minutes for the system to finish the update. More time may be needed, depending on the network environment.
- Do not operate the unit or the remote during updating. Moreover, do not turn off the system or disconnect the power cord during updating.

## About "SongPal"

### Sound settings

You can easily customize your sound.

### Music service

You can enjoy various music services.

### Controlling devices on your home network

You can play music stored in your PC or DLNA server over your network.

### Controlling a CD inserted in the unit, or a device connected via USB

You can play a CD that is inserted in the unit or music in a device connected to the USB connector.

What you can control with "SongPal" varies depending on the connected device. The specification and design of the app may change without notice.

### Device Select

Select a "SongPal" compatible device.

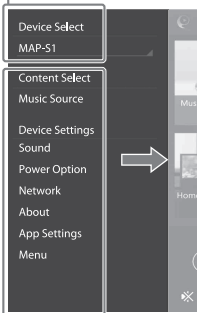

### Settings of the connected device

Various sound/network settings are displayed. This menu can be displayed from any screen by flicking right.

### Home screen

Displays functions of selected device, music services, and apps installed on your smartphone/iPhone.

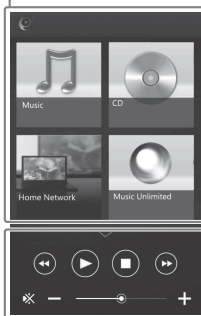

### Mini player

Controller for selected function.

# Troubleshooting

If a problem occurs while operating the system, follow the steps described below before consulting your nearest Sony dealer. If an error message appears, be sure to make a note of the contents for reference.

1 Check to see if the problem is listed in this "Troubleshooting" section.

2 Check the following customer support websites.

For customers in Europe:

<http://support.sony-europe.com/>

For customers in other countries/  
regions:

<http://www.sony-asia.com/support>

You will find the latest support information and a FAQ at these websites.

3 If, after steps 1 and 2, you still cannot solve the problem, consult your nearest Sony dealer. If the problem persists after doing all of the above, consult your nearest Sony dealer.

When bringing the product in for repairs, be sure to bring in the entire system (main unit and remote). This product is a system product, and the entire system is needed to determine the section requiring repair.

## If the standby indicator flashes

Immediately unplug the power cord and make sure the speaker cord is not hot.

- Is the speaker cord shorted out? After the standby indicator stops flashing, plug the power cord again, and turn on the system. If the issue persists, contact your nearest Sony dealer.

## General

The system does not turn on.

- ➔ Make sure you have connected the power cord to a wall outlet correctly.

The system has entered Standby mode unexpectedly.

- ➔ This is not a malfunction. The system enters Standby mode automatically in about 15 minutes when there is no operation or audio signal output. See "Setting the Automatic Standby function" (page 30).

The clock setting or the Play Timer operation has been canceled unexpectedly.

- ➔ If about a minute elapses with no operation, the clock setting or Play Timer setting is canceled automatically. Perform the operation again from the beginning.

There is no sound.

- ➔ Make sure the speaker cords are connected correctly.
- ➔ Turn up the volume on the unit.
- ➔ Make sure the headphones are disconnected from the PHONES jack.
- ➔ Make sure the component is connected correctly to the LINE IN (external input) jack and set the function to LINE IN.
- ➔ The specified station may have temporarily stopped broadcast.

Left and right sound balance is unclear or reversed.

- ➔ Put the speakers symmetrically.
- ➔ Make sure that speaker cords L/R and +/- are connected correctly.

Severe hum or noise occurs.

- ➔ Move the system away from sources of noise.
- ➔ Connect the system to a different wall outlet.
- ➔ Use of an AC power tap with a noise filter (not supplied) is recommended.

The remote does not function.

- ➔ Remove any obstacles between the remote and the remote sensor on the unit, and position the unit away from fluorescent lights.
- ➔ Point the remote at the remote sensor on the unit.

- ➔ Move the remote closer to the system.
- ➔ Replace the new batteries.

## CD-DA/MP3 disc

“Locked” appears in the display window and the disc cannot be removed from the disc slot.

- ➔ Consult your nearest Sony dealer or local authorized Sony service facility.

The disc or file will not play.

- ➔ The disc has not been finalized (a CD-R or CD-RW disc to which data can be added).

The sound skips, or the disc will not play.

- ➔ The disc may be dirty or scratched. When the disc is dirty, wipe it clean.
- ➔ Move the system to a location away from vibration (for example, on top of a stable stand).
- ➔ Oscillation of the speakers may be the cause of sound skips, depending on the volume level. Move the speakers away from the unit or change the location of the speakers.

Play does not start from the first track or file.

- ➔ Make sure the current play mode is correct. If the play mode is “Shuffle” or “Program,” change the setting (page 11).

Starting playback takes more time than usual.

- ➔ The following discs can increase the time it takes to start playback:
  - a disc recorded with a complicated tree structure
  - a disc recorded in multi-session format
  - a disc that has many folders

## iPhone/iPad/iPod (when connected to USB port)

For details on compatible iPhone/iPad/iPod, see “Compatible devices and versions” (page 43).

There is no sound.

- ➔ Make sure the iPhone/iPad/iPod is connected securely to the ⚡ (USB FRONT) port.

- ➔ Stop playback and connect the iPhone/iPad/iPod to the system.
- ➔ Make sure the iPhone/iPad/iPod is updated with the latest software. If not, update the iPhone/iPad/iPod before using with the system.
- ➔ Turn up the volume.
- ➔ The iPhone/iPad/iPod may not be supported by this system.

The sound is distorted.

- ➔ Make sure the iPhone/iPad/iPod is connected securely to the ⚡ (USB FRONT) port.
- ➔ Turn up the volume.
- ➔ Set the equalizer setting of the iPhone/iPad/iPod to “Off” or “Flat.”
- ➔ The iPhone/iPad/iPod may not be supported by this system.

The iPhone/iPad/iPod does not function.

- ➔ Shut down any other iOS applications running on the iPhone/iPad/iPod. For details, refer to the operation manual supplied with the iPhone/iPad/iPod.
- ➔ Make sure the iPhone/iPad/iPod is connected securely to the ⚡ (USB FRONT) port.
- ➔ Make sure the iPhone/iPad/iPod is updated with the latest software. If not, update the iPhone/iPad/iPod before using with the system.
- ➔ Because the operation of the system and the iPhone/iPad/iPod are different, you may not be able to operate the iPhone/iPad/iPod using buttons on the remote or unit. In this case, use the control buttons on the iPhone/iPad/iPod.

The iPhone/iPad/iPod cannot be charged.

- ➔ Make sure the iPhone/iPad/iPod is connected securely to the ⚡ (USB FRONT) port via the cable supplied with the iPhone/iPad/iPod.
- ➔ Disconnect the iPhone/iPad/iPod and then reconnect it. For details on the charging status of the iPhone/iPad/iPod, see the operating manual of the iPhone/iPad/iPod.

## USB device

For details on compatible USB devices, see “Compatible devices and versions” (page 43).

An unsupported USB device is connected.

- ➔ The following problems may occur.
  - The USB device is not recognized.

- File or folder names are not displayed on this system.
- Playback is not possible.
- The sound skips.
- There is noise.
- A distorted sound is output.

---

There is no sound.

- ➔ The USB device is not connected correctly. Turn off the system, and then reconnect the USB device.

---

There is noise, skipping, or distorted sound.

- ➔ An unsupported USB device is connected. Connect a supported USB device.
- ➔ Turn off the system, then reconnect the USB device and turn on the system.
- ➔ The music data itself contains noise, or the sound is distorted. Noise may have been entered when creating music data due to the conditions of the computer. In this case, delete the file and send the music data again.
- ➔ The bit rate used when encoding the files was low. Send files encoded with higher bit rates to the USB device.
- ➔ If you play back High-Resolution Audio, use the device which is compatible with USB2.0 High Speed cable.

---

“Reading” is displayed for an extended time, or it takes a long time before playback starts.

- ➔ The reading process may take a long time in the following cases.
  - There are many folders or files on the USB device.
  - The file structure is extremely complex.
  - Not enough free space in the memory.
  - The internal memory is fragmented.

---

The file or folder name (album name) is not displayed correctly.

- ➔ Send the music data to the USB device again, as the data stored in the USB device may have been corrupted.
- ➔ The character code that can be displayed by this system are as follows:
  - Upper cases (A to Z).
  - Numbers (0 to 9).
  - Symbols (<> \* +, [ ] @ \ \_).
 Other characters appear as “\_.”

---

The USB device is not recognized.

- ➔ Turn off the system and reconnect the USB device, then turn on the system.
- ➔ An incompatible USB device may be connected.
- ➔ The USB device does not work properly. Refer to the operating manual supplied with the USB device for how to deal with this problem.

---

Play does not start.

- ➔ Turn off the system and reconnect the USB device, then turn on the system.
- ➔ An incompatible USB device may be connected.

---

Play does not start from the first track.

- ➔ Set the play mode to “Normal” play mode.

---

The USB device cannot be charged.

- ➔ Make sure the USB device is connected securely to the  $\Psi$  (USB REAR) port.
- ➔ Charging cannot be made when the power of the system is off.
- ➔ The USB device may not be supported by this system.
- ➔ Disconnect the USB device and then reconnect it. For details on the charging status of the USB device, see the operating manual of the USB device.

## Tuner

---

Severe hum or noise occurs (“STEREO” flashes in the display window), or broadcasts cannot be received.

- ➔ Connect the antenna properly.
- ➔ Find a location and an orientation that provide good reception, and then set up the antenna again.
- ➔ Keep the antennas away from the unit, speaker cord or other AV components to avoid picking up noise.
- ➔ Turn off nearby electrical equipment.

---

Several radio stations can be heard at the same time.

- ➔ Find a location and orientation that provide good reception, and adjust the speaker cord, then set up the antenna again.

- ➔ Bundle the antenna cables using commercially available cord clips and adjust the cable lengths.

---

DAB/DAB+ radio station is not received properly.

---

- ➔ Check all antenna connections, then perform the DAB Automatic Scan procedure. See "Running the DAB Automatic Scan manually" (page 15).
- ➔ The current DAB/DAB+ service may not be available. Press ◀◀/▶▶ to select a different service.
- ➔ If you have moved to another area, some services/frequencies may have changed and you may not be able to tune into your usual broadcast. Perform the DAB Automatic Scan procedure to re-register the contents of broadcasts. (Performing this procedure clears all previously stored presets.)

---

The DAB/DAB+ broadcast has been interrupted.

---

- ➔ Check the location of the system or adjust the orientation of the antenna to increase the indicated value of the signal quality.

## Network connection

---

The system cannot connect to the network. (Other equipment on the network cannot find or recognize the system.)

---

- ➔ Check that  is lit in the display window.
- ➔ It takes about 1 minute for the system to acquire an IP address when the system is turned on in a communication environment without a router.
- ➔ When you use a fixed IP address, the same IP address may be used by other equipment. Use a different IP address.

---

The system cannot connect to the network via a wireless LAN connection.

---

- ➔ If a network (LAN) cable is connected to the system, the system automatically operates to establish a wired LAN connection. If you wish to use a wireless LAN connection, do not connect a network (LAN) cable to the system.
- ➔ Check the settings of the wireless LAN router/access point. If the SSID stealth mode is set to "On" on the access point, set it to "Off." For details on the settings of the access point of the wireless router, refer to the operating manual for the access point.

---

The system cannot connect to the network using WPS.

---

- ➔ Set up your network after searching the access point using the access point scan.
- ➔ You cannot connect to a network using WPS when your access point is set to WEP.
- ➔ Update the firmware of the wireless LAN router/access point to the latest version.

## Music Services

---

The system cannot connect to Music Services.

---

- ➔ Make sure the wireless LAN router/access point is turned on.
- ➔ Check that  appears in the display window. If not, set up a wireless network again. For details, see Quick Start Guide.
- ➔ When the system is connected to a wireless network, place the wireless LAN/access point and the system closer together and perform the setup again.
- ➔ Depending on the providers, only one connection to Internet is allowed. In that case, the system cannot be connected if connection is occupied. Please consult your carrier or service provider.
- ➔ When you turn on your mobile phone (Android device, Xperia device, or iPhone/iPod touch) after a moment of power off, try to restart the "SongPal" application.

## Home Network

---

The controller (the operating device) cannot find this system. (The controller cannot browse the contents of this system.)

---

- ➔ Make sure that the controller is connected to the home network.
- ➔ The multicast control on the access point is enabled.

---

Music started automatically.

---

- ➔ This system may be controlled by another component. To reject the control, set the BLUETOOTH/Network Standby mode to off (page 31).

---

The sound is interrupted.

---

- ➔ The DLNA server is overloaded. Quit all running applications.

- ➔ Wireless signal condition is poor. Stop using your microwave oven.
- ➔ The communications speed of the wireless LAN may become slower for IEEE802.11n-compliant wireless LAN routers/access points if the security method is set to WEP or WPA/WPA2-PSK (TKIP). If the speed becomes lower, change the security method to WPA/WPA2-PSK (AES).  
The encryption (security) scheme varies depending on the device. For details, refer to the operating manual for your router/access point.

---

#### Tuning or playback cannot be performed.

---

- ➔ Confirm that the audio file is improper or has been deleted from the server. Refer to the operating manual of the server.
- ➔ The server tries to play the audio file in an audio format that the system does not support. Check the audio format information on the server.
- ➔ Disable the multicast control on the wireless LAN router/access point. If it is enabled, it may take several minutes to output the audio. For details, refer to the operating manual of the wireless LAN router/access point.
- ➔ The access from this system is not permitted by the server. Change the settings on the server to allow access from this system. For details, refer to the operating manual of the server.

## AirPlay

For details on compatible iPhone/iPad/iPod touch, see "Compatible devices and versions" (page 43).

---

#### The system cannot be found from an iPhone/iPad/iPod Touch.

---

- ➔ See "Network connection – The system cannot connect to the network" (page 39).
- ➔ Make sure the iPhone/iPad/iPod touch or the computer with iTunes is connected to your home network.
- ➔ Before using with the system, update iOS or iTunes to the latest version.

---

#### Music started automatically.

---

- ➔ This system may be controlled by another component. To reject the control, set the BLUETOOTH/Network Standby mode to off (page 31).

---

#### The sound is interrupted during playback.

---

- ➔ The server is overloaded. Quit all running applications.

---

#### This unit cannot be operated.

---

- ➔ Update the software version of the iPhone/iPad/iPod touch or iTunes to the latest version.

## To reset the system to factory settings

If the system still does not operate properly, reset the system to factory settings.

Use buttons on the unit to reset the system to its factory default settings.

- 1 Disconnect the power cord and confirm that the standby indicator is not lit. Then reconnect the power cord and turn on the system.
- 2 Press and hold PUSH ENTER and I/⏻ on the unit until "All Reset" appears in the display window.

All user-configured settings, such as the preset radio stations, clock, timer, and network, are deleted. Also, your login ID and password of the Internet music streaming (Music Services) will be deleted.

If the problem persists after doing all of the above, consult your nearest Sony dealer.

#### Note

- If you dispose of the unit or give it to another person, reset the unit for security.



---

# Messages

The following messages may appear or flash during operation.

## **Cannot Download**

The system failed downloading the update data while performing the software update. Enter the setting menu and update the software again.

## **Cannot Play**

You have set a disc that cannot be played back on this system, such as CD-ROM and DVD disc.

## **Complete!**

The station preset operation ended normally.

## **Data Error**

You tried to play an unplayable file.

## **Error**

You operated the system during initialization. Wait for a while until the initialization is completed.

## **Initial**

The system is initializing the network settings. Some buttons of the system cannot be operated during this process.

## **Locked**

The disc slot is locked and you cannot remove the disc. Contact your nearest Sony dealer.

## **No Connect**

The system cannot be connected to the network.

## **No Device**

No USB device is connected or the connected USB device has been removed.

## **No Disk**

There is no disc in the player, or you have loaded a disc that cannot be played.

## **No Memory**

The memory media is not inserted in the USB device, or the system does not identify the memory media.

## **No Step**

All of the programmed tracks have been erased.

## **Not Supported**

The system does not support the connected USB device.

## **No Track**

There are not playable files on the USB device or disc.

## **Not In Use**

You pressed an unplayable button.

## **Over Current**

Remove the USB device from the port and turn off the system then turn on the system.

## **Push STOP**

You attempted to change the play mode during playback in the CD or USB function.

## **Reading**

The system is reading the information on the CD or USB device. Some buttons do not work during reading.

## **Step Full!**

You tried to program more than 25 tracks or files.

## **Time NG!**

The Play Timer start and end times are set to the same time.

## **Update Error**

The system cannot update the software. Turn off the system, and then turn it on again. The system will try to update the software. If the same message appears, contact your nearest Sony dealer.

# Precautions

### Discs that this system CAN play

- Audio CD-DA discs
- CD-R/CD-RW (audio data of CD-DA tracks and MP3 files)

Do not use a CD-R/CD-RW disc with no data stored. Doing so may damage the disc.

### Discs that this system CANNOT play

- CD-ROM
- CD-R/CD-RW other than those recorded in music CD format or format conforming to ISO9660 Level 1/Level 2, Joliet
- CD-R/CD-RW recorded in multi-session format and not closed the session
- CD-R/CD-RW of poor recording quality, CD-R/CD-RW that have scratches or are dirty, or CD-R/CD-RW recorded with an incompatible recording device
- CD-R/CD-RW which is finalized incorrectly
- CD-R/CD-RW containing files other than MPEG 1 Audio Layer-3 (MP3) files
- 8 cm disc
- Discs of non-standard shape (for example, heart, square, star)
- Discs that have adhesive tape, paper, or sticker attached to them
- Rental or used discs with attached seals where the glue extends beyond the seal
- Discs that have labels printed using ink that feels tacky when touched

### Note on CD-DA discs

- Before playing, wipe the disc with a cleaning cloth from the center out to the edge.
- Do not clean discs with solvents, such as benzene, thinner, or commercially available cleaners or antistatic spray intended for vinyl LPs.
- Do not expose discs to direct sunlight or heat sources such as hot air ducts, nor leave it in a car parked in direct sunlight.

### On safety

- Completely disconnect the power cord (mains lead) from the wall outlet (mains) if it is not going to be used for an extended period of time. When unplugging the system, always grip the plug. Never pull the cord itself.
- Should any solid object or liquid get into the system, unplug the system, and have it checked by qualified personnel before operating it again.
- The AC power cord can be changed only by a qualified service facility.

### On placement

- Do not place the system in an inclined position or in locations that are extremely hot, cold, dusty, dirty, or humid or lacking adequate ventilation, or subject to vibration, direct sunlight or a bright light.
- Be careful when placing the system on surfaces that have been specially treated (for example, with wax, oil, polish) as staining or discoloration of the surface may result.
- If the system is brought directly from a cold to a warm location or is placed in a very damp room, moisture may condense on the lens inside the CD player, and cause the system to malfunction. In this situation, remove the disc, and leave the system turned on for about an hour until the moisture evaporates. If the system still does not operate, even after an extended period, consult your nearest Sony dealer.

### On heat buildup

- Heat buildup on the unit during charging or operation over a long period of time is normal and not cause for alarm.
- Do not touch the cabinet if it has been used continuously at a high volume because the cabinet may have become hot.
- Do not obstruct the ventilation holes.

### Cleaning the cabinet

Clean this system with a soft cloth slightly moistened with a mild detergent solution. Do not use any type of abrasive pads, scouring powder, or solvents, such as thinner, benzene, or alcohol.

# Compatible devices and versions

## iPhone/iPad/iPod or iTunes

Check the websites below for details on the latest supported versions of the compatible devices:

For customers in Europe:

<http://support.sony-europe.com/>

For customers in other countries/regions:

<http://www.sony-asia.com/support>

Compatible Models	AirPlay	BLUETOOTH®	USB
iPhone 5s	○	○	○
iPhone 5c	○	○	○
iPhone 5	○	○	○
iPhone 4s	○	○	○
iPhone 4	○	○	○
iPhone 3GS	○	○	○
iPad Air*	○	○	○
iPad mini with Retina display*	○	○	○
iPad (4th generation)*	○	○	○
iPad mini*	○	○	○
iPad (3rd generation)*	○	○	○
iPad 2*	○	○	○
iPad*	○	○	○
iPod touch (5th generation)	○	○	○
iPod touch (4th generation)	○	○	○
iPod touch (3rd generation)*	○	○	○

Compatible Models	AirPlay	BLUETOOTH®	USB
iPod classic*			○
iPod nano (7th generation)*		○	○
iPod nano (6th generation)*			○
iPod nano (5th generation)*			○
iPod nano (4th generation)*			○

\* "SongPal" does not support iPod touch (3rd generation), iPod classic, and iPod nano. "SongPal" does not support iPad as of January 2014.

AirPlay works with iPhone, iPad, and iPod touch with iOS 4.3.3 or later, Mac with OS X Mountain Lion, and Mac and PC with iTunes 10.2.2 or later.

Bluetooth technology works with iPhone 5s, iPhone 5c, iPhone 5, iPhone 4s, iPhone 4, iPhone 3GS, iPod touch (5th generation), iPod touch (4th generation).

USB function works with iPhone, iPad, and iPod touch with iOS 4.3.3 or later, Mac with OS X Mountain Lion, and Mac and PC with iTunes 10.2.2 or later.

## DLNA device

Check the websites below for details on the latest supported versions of the compatible devices:

For customers in Europe:

<http://support.sony-europe.com/>

For customers in other countries/regions:

<http://www.sony-asia.com/support>

## USB device

Check the websites below for details on the latest supported versions of the compatible devices:

For customers in Europe:

<http://support.sony-europe.com/>

For customers in other countries/regions:

<http://www.sony-asia.com/support>

## BLUETOOTH wireless technology

BLUETOOTH wireless technology is a short-range wireless technology linking digital devices, such as personal computers and digital still cameras. Using the BLUETOOTH wireless technology, you can operate the units involved within a range of about 10 meters.

The BLUETOOTH wireless technology is commonly used between two devices, but a single device can be connected to multiple devices.

You do not need wires to get connected as you do with a USB connection, and you do not need to place the devices face to face as you do with wireless infrared technology.

You can use the technology with one

BLUETOOTH device in your bag or pocket.

BLUETOOTH wireless technology is a global standard supported by thousands of companies. These companies produce products that meet the global standard.

### Supported BLUETOOTH version and profiles

Profile refers to a standard set of capabilities for various BLUETOOTH product capabilities. See "Specifications" (page 46) for details on the supported BLUETOOTH version and profiles.

#### Note

- To use a BLUETOOTH device connected to this system, the device must support the same profile as this system. Note that the functions of the BLUETOOTH device may be different depending on the specifications of the device, even if it has the same profile as this system.
- Because of the properties of BLUETOOTH wireless technology, playback on this system is slightly delayed compared with audio playback on the transmitting device.

### Effective communication range

BLUETOOTH devices should be used within approximately 10 meters (unobstructed distance) of each other.

The effective communication range may become shorter under the following conditions.

- When a person, metal object, wall or other obstruction is between the devices with a BLUETOOTH connection
- Locations where a wireless LAN is installed
- Around microwave ovens that are in use
- Locations where other electromagnetic waves occur

### Effects of other devices

BLUETOOTH devices and wireless LAN (IEEE802.11b/g) use the same frequency band (2.4 GHz). When using your BLUETOOTH device near a device with wireless LAN capability, electromagnetic interference may occur.

This could result in lower data transfer rates, noise, or inability to connect. If this happens, try the following remedies:

- Try connecting this system and BLUETOOTH mobile phone or BLUETOOTH device when you are at least 10 meters away from the wireless LAN equipment.
- Turn off the power to the wireless LAN equipment when using your BLUETOOTH device within 10 meters

### Effects on other devices

The radio waves broadcast by this system may interfere with the operation of some medical devices. Since this interference may result in malfunction, always turn off the power on this system, BLUETOOTH mobile phone and BLUETOOTH device in the following locations:

- In hospitals, on trains, and in airplanes
- Near automatic doors or fire alarms

#### Note

- This system supports security functions that comply with the BLUETOOTH specification as a means of ensuring security during communication using BLUETOOTH technology. However, this security may be insufficient depending on the setting contents and other factors, so always be careful when performing communication using BLUETOOTH technology.
- Sony cannot be held liable in any way for damages or other loss resulting from information leaks during communication using BLUETOOTH technology.
- BLUETOOTH communication is not necessarily guaranteed with all BLUETOOTH devices that have the same profile as this system.

- BLUETOOTH devices connected with this system must comply with the BLUETOOTH specification prescribed by the BLUETOOTH SIG, Inc., and must be certified to comply. However, even when a device complies with the BLUETOOTH specification, there may be cases where the characteristics or specifications of the BLUETOOTH device make it impossible to connect, or may result in different control methods, display or operation.
- Noise may occur or the audio may cut off depending on the BLUETOOTH device connected with this system, the communications environment, or surrounding conditions.

---

# Specifications

---

## Amplifier section

### Power output (rated):

50 watts + 50 watts (at 4 ohms, 1 kHz)\*1

\*1 Measured under the following conditions:  
Power requirements: 230V AC, 50Hz

### Speaker impedance match

4 ohms - 16 ohms

---

## Inputs/Outputs

### LINE IN (external input) jack:

Sensitivity: 2 V

Impedance: 47 kilo ohms

### LINE OUT (external output) jack:

Output voltage: 2 V

Impedance: 1 kilo ohms

5 Hz – 80 kHz (-3 dB)

### PHONES (headphone) jack:

Stereo standard jack, 8 ohms or more

### USB:

USB port: Type A, 5 V DC 2.1 A

### DIGITAL IN jack:

USB port: Type B

---

## CD-DA/MP3 player section

### System:

Compact disc and digital audio system

### Laser Diode Properties:

Emission Duration: Continuous

Laser Output\*2: Less than 44.6  $\mu$ W

\*2 This output is the value measurement at a distance of 200mm from the objective lens surface on the Optical Pick-up Block with 7mm aperture.

### Frequency response:

10 Hz – 20 kHz

### Signal-to-noise ratio:

More than 90 dB

### Dynamic range:

More than 90 dB

---

## Tuner section

### AM tuner section:

Tuning range:

European model:

531 kHz-1,602 kHz (with 9 kHz tuning interval)

Other models:

530 kHz-1,710 kHz (with 10 kHz tuning interval)

531 kHz-1,710 kHz (with 9 kHz tuning interval)

Antenna:

AM loop antenna

Intermediate frequency:

400 kHz

### FM tuner section:

FM stereo, FM superheterodyne tuner

Tuning range:

87.5 MHz – 108.0 MHz (50 kHz step)

Antenna:

FM lead antenna

Antenna terminals:

DAB/FM lead antenna

75 ohms unbalanced

### DAB/DAB+ tuner section:

FM stereo, DAB/FM superheterodyne tuner

Frequency range:

Band-III:

174.928 (5A) MHz – 239.200 (13F) MHz\*3

Antenna:

DAB/FM lead antenna:

### DAB/DAB+ frequency table (Band-III):

Frequency	Label
174.928 MHz	5A
176.640 MHz	5B
178.352 MHz	5C
180.064 MHz	5D
181.936 MHz	6A
183.648 MHz	6B
185.360 MHz	6C
187.072 MHz	6D

---

Frequency	Label
188.928 MHz	7A
190.640 MHz	7B
192.352 MHz	7C
194.064 MHz	7D
195.936 MHz	8A
197.648 MHz	8B
199.360 MHz	8C
201.072 MHz	8D
202.928 MHz	9A
204.640 MHz	9B
206.352 MHz	9C
208.064 MHz	9D
209.936 MHz	10A
211.648 MHz	10B
213.360 MHz	10C
215.072 MHz	10D
216.928 MHz	11A
218.640 MHz	11B
220.352 MHz	11C
222.064 MHz	11D
223.936 MHz	12A
225.648 MHz	12B
227.360 MHz	12C
229.072 MHz	12D
230.784 MHz	13A
232.496 MHz	13B
234.208 MHz	13C
235.776 MHz	13D
237.488 MHz	13E

Frequency	Label
239.200 MHz	13F

\*3 Frequencies are displayed to two decimal places on this system.

## BLUETOOTH section

### Communication system:

BLUETOOTH Standard version 3.0

### Output:

BLUETOOTH Standard Power Class 2

### Maximum communication range:

Line of sight approx. 10 m\*4

### Frequency band:

2.4 GHz band (2.4000 GHz - 2.4835 GHz)

### Modulation method:

FHSS

### Compatible BLUETOOTH profiles\*5:

A2DP (Advanced Audio Distribution Profile)  
AVRCP (Audio Video Remote Control Profile)

### Supported content protection method

SCMS-T method

### Supported codec

SBC (Sub Band Codec), AAC, aptX

### Transmission bandwidth

20 Hz – 20,000 Hz (with 44.1 kHz sampling)

\*4 The actual range will vary depending on factors such as obstacles between devices, magnetic fields around a microwave oven, static electricity, reception sensitivity, antenna's performance, operating system, software application, etc.

\*5 BLUETOOTH standard profiles indicate the purpose of BLUETOOTH communication between devices.

## Network section

### LAN port:

RJ-45

10BASE-T/100BASE-TX

(The communication speed may vary depending on the communication environment. This system does not guarantee the communication speed and quality of 10BASE-T/100BASE-TX.)

**Wireless LAN:**

Compatible standards:

IEEE 802.11 b/g (WEP 64 bit, WEP 128 bit)  
Frequency band 2.4 GHz band (2.4000 GHz - 2.4835 GHz)

Available channels ch1 to ch13

WEP 64 bit, WEP 128 bit

WPA/WPA2-PSK (AES)

WPA/WPA2-PSK (TKIP)

**Compatible formats:**

PCM 192 kHz/24 bit, DSD 2.8 MHz/1 bit  
DSD (DSF, DSDIFF), LPCM (WAV, AIFF), FLAC,  
ALAC, MP3, AAC, WMA

---

**General****Power requirements:**

AC 220 V - 240 V, 50 Hz/60 Hz

**Power consumption:**

55 watts

**Dimensions (W/H/D) (incl. projecting parts):**

Approx. 251 mm x 115 mm x 290 mm

**Mass:**

Approx. 5.6 kg

**Supplied accessories:**

Remote (RM-AMU209) (1), R03 (Size AAA) batteries (2), AC power cord (1), DAB/FM lead antenna (2), AM loop antenna (1), Quick Setup Guide (1), Operating Instructions (this manual) (1)

Design and specifications are subject to change without notice.

Standby power consumption: 0.5 W (all wireless network ports off) Networked Standby mode: 16 W (all wireless network ports on)
---



## Trademarks, etc.

- Windows, the Windows logo, and Windows Media are either registered trademarks or trademarks of Microsoft Corporation in the United States and/or other countries.
- This product is protected by certain intellectual property rights of Microsoft Corporation. Use or distribution of such technology outside of this product is prohibited without a license from Microsoft or an authorized Microsoft subsidiary.
- Apple, the Apple logo, AirPlay, iPad, iPhone, iPod, iPod classic, iPod nano, iPod touch, iTunes, Mac, iOS and OS X are trademarks of Apple Inc., registered in the U.S. and other countries. App Store is a service mark of Apple Inc.
- "Made for iPod," "Made for iPhone," and "Made for iPad" mean that an electronic accessory has been designed to connect specifically to iPod, iPhone or iPad, respectively, and has been certified by the developer to meet Apple performance standards. Apple is not responsible for the operation of this device or its compliance with safety and regulatory standards. Please note that the use of this accessory with iPod, iPhone or iPad may affect wireless performance.
- Wi-Fi®, Wi-Fi Protected Access® and Wi-Fi Alliance® are registered marks of the Wi-Fi Alliance.
- Wi-Fi CERTIFIED™, WPA™, WPA2™ and Wi-Fi Protected Setup™ are marks of the Wi-Fi Alliance.
- DLNA™, the DLNA Logo and DLNA CERTIFIED™ are trademarks, service marks, or certification marks of the Digital Living Network Alliance.
- "WALKMAN" and "WALKMAN" logo are registered trademarks of Sony Corporation.
- MPEG Layer-3 audio coding technology and patents licensed from Fraunhofer IIS and Thomson.
- © 2013 CSR plc and its group companies. The aptX® mark and the aptX logo are trademarks of CSR plc or one of its group companies and may be registered in one or more jurisdictions.
- The BLUETOOTH® word mark and logos are registered trademarks owned by BLUETOOTH SIG, Inc. and any use of such marks by Sony Corporation is under license.
- The N Mark is a trademark or registered trademark of NFC Forum, Inc. in the United States and in other countries.
- Android and Google Play are trademarks of Google Inc.
- "Xperia" and "Xperia Tablet" are trademarks of Sony Mobile Communications AB.
- The system names and product names indicated in this manual are generally the trademarks or registered trademarks of the manufacturer. ™ and ® marks are omitted in this manual.
- This product incorporates Spotify software which is subject to 3rd party licenses found here:

<http://www.spotify.com/connect/third-party-licenses>

- Spotify and Spotify logos are trademarks of the Spotify Group.

# Important information on software

This section covers the software used by this system.

## ALAC

Apache License  
Version 2.0, January 2004  
<http://www.apache.org/licenses/>

### TERMS AND CONDITIONS FOR USE, REPRODUCTION, AND DISTRIBUTION

#### 1. Definitions.

"License" shall mean the terms and conditions for use, reproduction, and distribution as defined by Sections 1 through 9 of this document.

"Licensor" shall mean the copyright owner or entity authorized by the copyright owner that is granting the License.

"Legal Entity" shall mean the union of the acting entity and all other entities that control, are controlled by, or are under common control with that entity. For the purposes of this definition, "control" means (i) the power, direct or indirect, to cause the direction or management of such entity, whether by contract or otherwise, or (ii) ownership of fifty percent (50%) or more of the outstanding shares, or (iii) beneficial ownership of such entity.

"You" (or "Your") shall mean an individual or Legal Entity exercising permissions granted by this License.

"Source" form shall mean the preferred form for making modifications, including but not limited to software source code, documentation source, and configuration files.

"Object" form shall mean any form resulting from mechanical transformation or translation of a Source form, including but not limited to compiled object code, generated documentation, and conversions to other media types.

"Work" shall mean the work of authorship, whether in Source or Object form, made available under the License, as indicated by a copyright notice that is included in or attached to the work (an example is provided in the Appendix below).

"Derivative Works" shall mean any work, whether in Source or Object form, that is based on (or derived from) the Work and for which the editorial revisions, annotations, elaborations, or other modifications represent, as a whole, an original work of authorship. For the purposes of this License, Derivative Works shall not include works that remain separate from, or merely link (or bind by name) to the interfaces of, the Work and Derivative Works thereof.

"Contribution" shall mean any work of authorship, including the original version of the Work and any modifications or additions to that Work or Derivative Works thereof, that is intentionally submitted to Licensor for inclusion in the Work by the copyright owner or by an individual or Legal Entity authorized to submit on behalf of the copyright owner. For the purposes of this definition, "submitted" means any form of electronic, verbal, or written communication sent to the Licensor or its representatives, including but not limited to communication on electronic mailing lists, source code control systems, and issue tracking systems that are managed by, or on behalf of, the Licensor for the purpose of discussing and improving the Work, but excluding communication that is conspicuously marked or otherwise designated in writing by the copyright owner as "Not a Contribution."

"Contributor" shall mean Licensor and any individual or Legal Entity on behalf of whom a Contribution has been received by Licensor and subsequently incorporated within the Work.

- Grant of Copyright License. Subject to the terms and conditions of this License, each Contributor hereby grants to You a perpetual, worldwide, non-exclusive, no-charge, royalty-free, irrevocable copyright license to reproduce, prepare Derivative Works of, publicly display, publicly perform, sublicense, and distribute the Work and such Derivative Works in Source or Object form.
- Grant of Patent License. Subject to the terms and conditions of this License, each Contributor hereby grants to You a perpetual, worldwide, non-exclusive, no-charge, royalty-free, irrevocable (except as stated in this section) patent license to make, have made, use, offer to sell, sell, import, and otherwise transfer the Work,

where such license applies only to those patent claims licensable by such Contributor that are necessarily infringed by their Contribution(s) alone or by combination of their Contribution(s) with the Work to which such Contribution(s) was submitted. If You institute patent litigation against any entity (including a cross-claim or counterclaim in a lawsuit) alleging that the Work or a Contribution incorporated within the Work constitutes direct or contributory patent infringement, then any patent licenses granted to You under this License for that Work shall terminate as of the date such litigation is filed.

- Redistribution. You may reproduce and distribute copies of the Work or Derivative Works thereof in any medium, with or without modifications, and in Source or Object form, provided that You meet the following conditions:

(a) You must give any other recipients of the Work or Derivative Works a copy of this License; and

(b) You must cause any modified files to carry prominent notices stating that You changed the files; and

(c) You must retain, in the Source form of any Derivative Works that You distribute, all copyright, patent, trademark, and attribution notices from the Source form of the Work, excluding those notices that do not pertain to any part of the Derivative Works; and

(d) If the Work includes a "NOTICE" text file as part of its distribution, then any Derivative Works that You distribute must include a readable copy of the attribution notices contained within such NOTICE file, excluding those notices that do not pertain to any part of the Derivative Works, in at least one of the following places: within a NOTICE text file distributed as part of the Derivative Works; within the Source form or documentation, if provided along with the Derivative Works; or, within a display generated by the Derivative Works, if and wherever such third-party notices normally appear. The contents of the NOTICE file are for informational purposes only and do not modify the License. You may add Your own attribution notices within Derivative Works that You distribute, alongside or as an addendum to the NOTICE text from the Work, provided that such additional attribution notices cannot be construed as modifying the License.

You may add Your own copyright statement to Your modifications and may provide additional or different license terms and conditions for use, reproduction, or distribution of Your modifications, or for any such Derivative Works as a whole, provided Your use, reproduction, and distribution of the Work otherwise complies with the conditions stated in this License.

- Submission of Contributions. Unless You explicitly state otherwise, any Contribution intentionally submitted for inclusion in the Work by You to the Licensor shall be under the terms and conditions of this License, without any additional terms or conditions. Notwithstanding the above, nothing herein shall supersede or modify the terms of any separate license agreement you may have executed with Licensor regarding such Contributions.
- Trademarks. This License does not grant permission to use the trade names, trademarks, service marks, or product names of the Licensor, except as required for reasonable and customary use in describing the origin of the Work and reproducing the content of the NOTICE file.
- Disclaimer of Warranty. Unless required by applicable law or agreed to in writing, Licensor provides the Work (and each Contributor provides its Contributions) on an "AS IS" BASIS, WITHOUT WARRANTIES OR CONDITIONS OF ANY KIND, either express or implied, including, without limitation, any warranties or conditions of TITLE, NON-INFRINGEMENT, MERCHANTABILITY, or FITNESS FOR A PARTICULAR PURPOSE. You are solely responsible for determining the appropriateness of using or redistributing the Work and assume any risks associated with Your exercise of permissions under this License.
- Limitation of Liability. In no event and under no legal theory, whether in tort (including negligence), contract, or otherwise, unless required by applicable law (such as deliberate and grossly negligent acts) or agreed to in writing, shall any Contributor be liable to You for damages, including any direct, indirect, special, incidental, or consequential damages of any character arising as a result of this License or out of the use or inability to use the Work (including but not limited to damages for loss of goodwill, work stoppage,

computer failure or malfunction, or any and all other commercial damages or losses), even if such Contributor has been advised of the possibility of such damages.

9. Accepting Warranty or Additional Liability. While redistributing the Work or Derivative Works thereof, You may choose to offer, and charge a fee for, acceptance of support, warranty, indemnity, or other liability obligations and/or rights consistent with this License. However, in accepting such obligations, You may act only on Your own behalf and on Your sole responsibility, not on behalf of any other Contributor, and only if You agree to indemnify, defend, and hold each Contributor harmless for any liability incurred by, or claims asserted against, such Contributor by reason of your accepting any such warranty or additional liability.

## END OF TERMS AND CONDITIONS

### APPENDIX: How to apply the Apache License to your work.

To apply the Apache License to your work, attach the following boilerplate notice, with the fields enclosed by brackets "[ ]" replaced with your own identifying information. (Don't include the brackets!) The text should be enclosed in the appropriate comment syntax for the file format. We also recommend that a file or class name and description of purpose be included on the same "printed page" as the copyright notice for easier identification within third-party archives.

Copyright [yyyy] [name of copyright owner]

Licensed under the Apache License, Version 2.0 (the "License"); you may not use this file except in compliance with the License. You may obtain a copy of the License at

<http://www.apache.org/licenses/LICENSE-2.0>

Unless required by applicable law or agreed to in writing, software distributed under the License is distributed on an "AS IS" BASIS, WITHOUT WARRANTIES OR CONDITIONS OF ANY KIND, either express or implied.

See the License for the specific language governing permissions and limitations under the License.

## mdNSResponder

Apache License  
Version 2.0, January 2004  
<http://www.apache.org/licenses/>

### TERMS AND CONDITIONS FOR USE, REPRODUCTION, AND DISTRIBUTION

#### 1. Definitions.

"License" shall mean the terms and conditions for use, reproduction, and distribution as defined by Sections 1 through 9 of this document.

"Licensor" shall mean the copyright owner or entity authorized by the copyright owner that is granting the License.

"Legal Entity" shall mean the union of the acting entity and all other entities that control, are controlled by, or are under common control with that entity. For the purposes of this definition, "control" means (i) the power, direct or indirect, to cause the direction or management of such entity, whether by contract or otherwise, or (ii) ownership of fifty percent (50%) or more of the outstanding shares, or (iii) beneficial ownership of such entity.

"You" (or "Your") shall mean an individual or Legal Entity exercising permissions granted by this License.

"Source" form shall mean the preferred form for making modifications, including but not limited to software source code, documentation source, and configuration files.

"Object" form shall mean any form resulting from mechanical transformation or translation of a Source form, including but not limited to compiled object code, generated documentation, and conversions to other media types.

"Work" shall mean the work of authorship, whether in Source or Object form, made available under the License, as indicated by a copyright notice that is included in or attached to the work (an example is provided in the Appendix below).

"Derivative Works" shall mean any work, whether in Source or Object form, that is based on (or derived from) the Work and for which the editorial revisions, annotations, elaborations, or other modifications represent, as a whole, an original work of authorship. For the purposes of this License, Derivative Works shall not include works that remain separate from, or merely link (or bind by name) to the interfaces of, the Work and Derivative Works thereof.

"Contribution" shall mean any work of authorship, including the original version of the Work and any modifications or additions to

that Work or Derivative Works thereof, that is intentionally submitted to Licensor for inclusion in the Work by the copyright owner or by an individual or Legal Entity authorized to submit on behalf of the copyright owner. For the purposes of this definition, "submitted" means any form of electronic, verbal, or written communication sent to the Licensor or its representatives, including but not limited to communication on electronic mailing lists, source code control systems, and issue tracking systems that are managed by, or on behalf of, the Licensor for the purpose of discussing and improving the Work, but excluding communication that is conspicuously marked or otherwise designated in writing by the copyright owner as "Not a Contribution."

"Contributor" shall mean Licensor and any individual or Legal Entity on behalf of whom a Contribution has been received by Licensor and subsequently incorporated within the Work.

2. Grant of Copyright License. Subject to the terms and conditions of this License, each Contributor hereby grants to You a perpetual, worldwide, non-exclusive, no-charge, royalty-free, irrevocable copyright license to reproduce, prepare Derivative Works of, publicly display, publicly perform, sublicense, and distribute the Work and such Derivative Works in Source or Object form.
  3. Grant of Patent License. Subject to the terms and conditions of this License, each Contributor hereby grants to You a perpetual, worldwide, non-exclusive, no-charge, royalty-free, irrevocable (except as stated in this section) patent license to make, have made, use, offer to sell, sell, import, and otherwise transfer the Work, where such license applies only to those patent claims licensable by such Contributor that are necessarily infringed by their Contribution(s) alone or by combination of their Contribution(s) with the Work to which such Contribution(s) was submitted. If You institute patent litigation against any entity (including a cross-claim or counterclaim in a lawsuit) alleging that the Work or a Contribution incorporated within the Work constitutes direct or contributory patent infringement, then any patent licenses granted to You under this License for that Work shall terminate as of the date such litigation is filed.
  4. Redistribution. You may reproduce and distribute copies of the Work or Derivative Works thereof in any medium, with or without modifications, and in Source or Object form, provided that You meet the following conditions:
    - (a) You must give any other recipients of the Work or Derivative Works a copy of this License; and
    - (b) You must cause any modified files to carry prominent notices stating that You changed the files; and
    - (c) You must retain, in the Source form of any Derivative Works that You distribute, all copyright, patent, trademark, and attribution notices from the Source form of the Work, excluding those notices that do not pertain to any part of the Derivative Works; and
    - (d) If the Work includes a "NOTICE" text file as part of its distribution, then any Derivative Works that You distribute must include a readable copy of the attribution notices contained within such NOTICE file, excluding those notices that do not pertain to any part of the Derivative Works, in at least one of the following places: within a NOTICE text file distributed as part of the Derivative Works; within the Source form or documentation, if provided along with the Derivative Works; or, within a display generated by the Derivative Works, if and wherever such third-party notices normally appear. The contents of the NOTICE file are for informational purposes only and do not modify the License. You may add Your own attribution notices within Derivative Works that You distribute, alongside or as an addendum to the NOTICE text from the Work, provided that such additional attribution notices cannot be construed as modifying the License.
- You may add Your own copyright statement to Your modifications and may provide additional or different license terms and conditions for use, reproduction, or distribution of Your modifications, or for any such Derivative Works as a whole, provided Your use, reproduction, and distribution of the Work otherwise complies with the conditions stated in this License.
5. Submission of Contributions. Unless You explicitly state otherwise, any Contribution intentionally submitted for inclusion in the Work by You to the Licensor shall be under the terms and conditions of this License, without any additional terms or conditions. Notwithstanding the above, nothing herein shall supersede or modify the terms of any separate license agreement you may have executed with Licensor regarding such Contributions.
  6. Trademarks. This License does not grant permission to use the trade names, trademarks, service marks, or product names of the Licensor, except as required for reasonable and customary use in

describing the origin of the Work and reproducing the content of the NOTICE file.

- Disclaimer of Warranty. Unless required by applicable law or agreed to in writing, Licensor provides the Work (and each Contributor provides its Contributions) on an "AS IS" BASIS, WITHOUT WARRANTIES OR CONDITIONS OF ANY KIND, either express or implied, including, without limitation, any warranties or conditions of TITLE, NON-INFRINGEMENT, MERCHANTABILITY, or FITNESS FOR A PARTICULAR PURPOSE. You are solely responsible for determining the appropriateness of using or redistributing the Work and assume any risks associated with Your exercise of permissions under this License.
- Limitation of Liability. In no event and under no legal theory, whether in tort (including negligence), contract, or otherwise, unless required by applicable law (such as deliberate and grossly negligent acts) or agreed to in writing, shall any Contributor be liable to You for damages, including any direct, indirect, special, incidental, or consequential damages of any character arising as a result of this License or out of the use or inability to use the Work (including but not limited to damages for loss of goodwill, work stoppage, computer failure or malfunction, or any and all other commercial damages or losses), even if such Contributor has been advised of the possibility of such damages.
- Accepting Warranty or Additional Liability. While redistributing the Work or Derivative Works thereof, You may choose to offer, and charge a fee for, acceptance of support, warranty, indemnity, or other liability obligations and/or rights consistent with this License. However, in accepting such obligations, You may act only on Your own behalf and on Your sole responsibility, not on behalf of any other Contributor, and only if You agree to indemnify, defend, and hold each Contributor harmless for any liability incurred by, or claims asserted against, such Contributor by reason of your accepting any such warranty or additional liability.

#### END OF TERMS AND CONDITIONS

APPENDIX: How to apply the Apache License to your work.

To apply the Apache License to your work, attach the following boilerplate notice, with the fields enclosed by brackets "[]" replaced with your own identifying information. (Don't include the brackets!) The text should be enclosed in the appropriate comment syntax for the file format. We also recommend that a file or class name and description of purpose be included on the same "printed page" as the copyright notice for easier identification within third-party archives.

Copyright [yyyy] [name of copyright owner]

Licensed under the Apache License, Version 2.0 (the "License"); you may not use this file except in compliance with the License. You may obtain a copy of the License at

<http://www.apache.org/licenses/LICENSE-2.0>

Unless required by applicable law or agreed to in writing, software distributed under the License is distributed on an "AS IS" BASIS, WITHOUT WARRANTIES OR CONDITIONS OF ANY KIND, either express or implied.

See the License for the specific language governing permissions and limitations under the License.

## libFLAC

Copyright (C) 2000, 2001, 2002, 2003, 2004, 2005, 2006, 2007 Josh Coalson

Redistribution and use in source and binary forms, with or without modification, are permitted provided that the following conditions are met:

- Redistributions of source code must retain the above copyright notice, this list of conditions and the following disclaimer.
- Redistributions in binary form must reproduce the above copyright notice, this list of conditions and the following disclaimer in the documentation and/or other materials provided with the distribution.
- Neither the name of the Xiph.org Foundation nor the names of its contributors may be used to endorse or promote products derived from this software without specific prior written permission.

THIS SOFTWARE IS PROVIDED BY THE COPYRIGHT HOLDERS AND CONTRIBUTORS "AS IS" AND ANY EXPRESS OR IMPLIED WARRANTIES, INCLUDING, BUT NOT LIMITED TO, THE IMPLIED WARRANTIES OF MERCHANTABILITY AND FITNESS FOR A PARTICULAR PURPOSE ARE DISCLAIMED. IN NO EVENT SHALL THE FOUNDATION OR CONTRIBUTORS BE LIABLE FOR ANY DIRECT, INDIRECT, INCIDENTAL, SPECIAL, EXEMPLARY, OR CONSEQUENTIAL DAMAGES (INCLUDING, BUT NOT LIMITED TO, PROCUREMENT OF SUBSTITUTE GOODS OR SERVICES; LOSS

OF USE, DATA, OR PROFITS; OR BUSINESS INTERRUPTION) HOWEVER CAUSED AND ON ANY THEORY OF LIABILITY, WHETHER IN CONTRACT, STRICT LIABILITY, OR TORT (INCLUDING NEGLIGENCE OR OTHERWISE) ARISING IN ANY WAY OUT OF THE USE OF THIS SOFTWARE, EVEN IF ADVISED OF THE POSSIBILITY OF SUCH DAMAGE.

## WPA Supplicant

=====

Copyright (c) 2003-2013, Jouni Malinen <j@w1.fi> and contributors  
All Rights Reserved.

This program is licensed under the BSD license (the one with advertisement clause removed).

If you are submitting changes to the project, please see CONTRIBUTIONS file for more instructions.

#### License

-----

This software may be distributed, used, and modified under the terms of BSD license:

Redistribution and use in source and binary forms, with or without modification, are permitted provided that the following conditions are met:

- Redistributions of source code must retain the above copyright notice, this list of conditions and the following disclaimer.
- Redistributions in binary form must reproduce the above copyright notice, this list of conditions and the following disclaimer in the documentation and/or other materials provided with the distribution.
- Neither the name(s) of the above-listed copyright holder(s) nor the names of its contributors may be used to endorse or promote products derived from this software without specific prior written permission.

THIS SOFTWARE IS PROVIDED BY THE COPYRIGHT HOLDERS AND CONTRIBUTORS "AS IS" AND ANY EXPRESS OR IMPLIED WARRANTIES, INCLUDING, BUT NOT LIMITED TO, THE IMPLIED WARRANTIES OF MERCHANTABILITY AND FITNESS FOR A PARTICULAR PURPOSE ARE DISCLAIMED. IN NO EVENT SHALL THE COPYRIGHT OWNER OR CONTRIBUTORS BE LIABLE FOR ANY DIRECT, INDIRECT, INCIDENTAL, SPECIAL, EXEMPLARY, OR CONSEQUENTIAL DAMAGES (INCLUDING, BUT NOT LIMITED TO, PROCUREMENT OF SUBSTITUTE GOODS OR SERVICES; LOSS OF USE, DATA, OR PROFITS; OR BUSINESS INTERRUPTION) HOWEVER CAUSED AND ON ANY THEORY OF LIABILITY, WHETHER IN CONTRACT, STRICT LIABILITY, OR TORT (INCLUDING NEGLIGENCE OR OTHERWISE) ARISING IN ANY WAY OUT OF THE USE OF THIS SOFTWARE, EVEN IF ADVISED OF THE POSSIBILITY OF SUCH DAMAGE.

## Expat

Copyright (c) 1998, 1999, 2000 Thai Open Source Software Center Ltd and Clark Cooper

Copyright (c) 2001, 2002, 2003, 2004, 2005, 2006 Expat maintainers.

Permission is hereby granted, free of charge, to any person obtaining a copy of this software and associated documentation files (the Software), to deal in the Software without restriction, including without limitation the rights to use, copy, modify, merge, publish, distribute, sublicense, and/or sell copies of the Software, and to permit persons to whom the Software is furnished to do so, subject to the following conditions:

The above copyright notice and this permission notice shall be included in all copies or substantial portions of the Software.

THE SOFTWARE IS PROVIDED "AS IS", WITHOUT WARRANTY OF ANY KIND, EXPRESS OR IMPLIED, INCLUDING BUT NOT LIMITED TO THE WARRANTIES OF MERCHANTABILITY, FITNESS FOR A PARTICULAR PURPOSE AND NONINFRINGEMENT.

IN NO EVENT SHALL THE AUTHORS OR COPYRIGHT HOLDERS BE LIABLE FOR ANY CLAIM, DAMAGES OR OTHER LIABILITY, WHETHER IN AN ACTION OF CONTRACT, TORT OR OTHERWISE, ARISING FROM, OUT OF OR IN CONNECTION WITH THE SOFTWARE OR THE USE OR OTHER DEALINGS IN THE SOFTWARE.

This product incorporates Spotify software which is subject to 3rd party licenses found here:

[www.spotify.com/connect/third-party-licenses](http://www.spotify.com/connect/third-party-licenses)

## Boost

<http://www.boost.org/>

Boost Software License - Version 1.0 - August 17th, 2003

Permission is hereby granted, free of charge, to any person or organization obtaining a copy of the software and accompanying documentation covered by this license (the "Software") to use, reproduce, display, distribute, execute, and transmit the Software, and to prepare derivative works of the Software, and to permit third-parties to whom the Software is furnished to do so, all subject to the following:

The copyright notices in the Software and this entire statement, including the above license grant, this restriction and the following disclaimer, must be included in all copies of the Software, in whole or in part, and all derivative works of the Software, unless such copies or derivative works are solely in the form of machine-executable object code generated by a source language processor.

THE SOFTWARE IS PROVIDED "AS IS", WITHOUT WARRANTY OF ANY KIND, EXPRESS OR IMPLIED, INCLUDING BUT NOT LIMITED TO THE WARRANTIES OF MERCHANTABILITY, FITNESS FOR A PARTICULAR PURPOSE, TITLE AND NON-INFRINGEMENT. IN NO EVENT SHALL THE COPYRIGHT HOLDERS OR ANYONE DISTRIBUTING THE SOFTWARE BE LIABLE FOR ANY DAMAGES OR OTHER LIABILITY, WHETHER IN CONTRACT, TORT OR OTHERWISE, ARISING FROM, OUT OF OR IN CONNECTION WITH THE SOFTWARE OR THE USE OR OTHER DEALINGS IN THE SOFTWARE.

## Expat

<http://www.jclark.com/xml/expat.html>

Expat License. Copyright (c) 1998, 1999, 2000 Thai Open Source Software Center Ltd

Permission is hereby granted, free of charge, to any person obtaining a copy of this software and associated documentation files (the "Software"), to deal in the Software without restriction, including without limitation the rights to use, copy, modify, merge, publish, distribute, sublicense, and/or sell copies of the Software, and to permit persons to whom the Software is furnished to do so, subject to the following conditions:

The above copyright notice and this permission notice shall be included in all copies or substantial portions of the Software.

THE SOFTWARE IS PROVIDED "AS IS", WITHOUT WARRANTY OF ANY KIND, EXPRESS OR IMPLIED, INCLUDING BUT NOT LIMITED TO THE WARRANTIES OF MERCHANTABILITY, FITNESS FOR A PARTICULAR PURPOSE AND NON-INFRINGEMENT. IN NO EVENT SHALL THE AUTHORS OR COPYRIGHT HOLDERS BE LIABLE FOR ANY CLAIM, DAMAGES OR OTHER LIABILITY, WHETHER IN AN ACTION OF CONTRACT, TORT OR OTHERWISE, ARISING FROM, OUT OF OR IN CONNECTION WITH THE SOFTWARE OR THE USE OR OTHER DEALINGS IN THE SOFTWARE.

## FastDelegate

<http://www.codeproject.com/KB/cpp/FastDelegate.aspx>

THE WORK (AS DEFINED BELOW) IS PROVIDED UNDER THE TERMS OF THIS CODE PROJECT OPEN LICENSE ("LICENSE"). THE WORK IS PROTECTED BY COPYRIGHT AND/OR OTHER APPLICABLE LAW. ANY USE OF THE WORK OTHER THAN AS AUTHORIZED UNDER THIS LICENSE OR COPYRIGHT LAW IS PROHIBITED.

BY EXERCISING ANY RIGHTS TO THE WORK PROVIDED HEREIN, YOU ACCEPT AND AGREE TO BE BOUND BY THE TERMS OF THIS LICENSE. THE AUTHOR GRANTS YOU THE RIGHTS CONTAINED HEREIN IN CONSIDERATION OF YOUR ACCEPTANCE OF SUCH TERMS AND CONDITIONS. IF YOU DO NOT AGREE TO ACCEPT AND BE BOUND BY THE TERMS OF THIS LICENSE, YOU CANNOT MAKE ANY USE OF THE WORK.

Definitions.

"Articles" means, collectively, all articles written by Author which describes how the Source Code and Executable Files for the Work may be used by a user.

"Author" means the individual or entity that offers the Work under the terms of this License.

"Derivative Work" means a work based upon the Work or upon the Work and other pre-existing works.

"Executable Files" refer to the executables, binary files, configuration and any required data files included in the Work.

"Publisher" means the provider of the website, magazine, CD-ROM, DVD or other medium from or by which the Work is obtained by You.

"Source Code" refers to the collection of source code and configuration files used to create the Executable Files.

"Standard Version" refers to such a Work if it has not been modified, or has been modified in accordance with the consent of the Author, such consent being in the full discretion of the Author.

"Work" refers to the collection of files distributed by the Publisher, including the Source Code, Executable Files, binaries, data files, documentation, whitepapers and the Articles.

"You" is you, an individual or entity wishing to use the Work and exercise your rights under this License.

Fair Use/Fair Use Rights. Nothing in this License is intended to reduce, limit, or restrict any rights arising from fair use, fair dealing, first sale or other limitations on the exclusive rights of the copyright owner under copyright law or other applicable laws.

License Grant. Subject to the terms and conditions of this License, the Author hereby grants You a worldwide, royalty-free, non-exclusive, perpetual (for the duration of the applicable copyright) license to exercise the rights in the Work as stated below:

You may use the standard version of the Source Code or Executable Files in Your own applications.

You may apply bug fixes, portability fixes and other modifications obtained from the Public Domain or from the Author. A Work modified in such a way shall still be considered the standard version and will be subject to this License.

You may otherwise modify Your copy of this Work (excluding the Articles) in any way to create a Derivative Work, provided that You insert a prominent notice in each changed file stating how, when and where You changed that file.

You may distribute the standard version of the Executable Files and Source Code or Derivative Work in aggregate with other (possibly commercial) programs as part of a larger (possibly commercial) software distribution.

The Articles discussing the Work published in any form by the author may not be distributed or republished without the Author's consent. The author retains copyright to any such Articles. You may use the Executable Files and Source Code pursuant to this License but you may not repost or republish or otherwise distribute or make available the Articles, without the prior written consent of the Author.

Any subroutines or modules supplied by You and linked into the Source Code or Executable Files this Work shall not be considered part of this Work and will not be subject to the terms of this License.

Patent License. Subject to the terms and conditions of this License, each Author hereby grants to You a perpetual, worldwide, non-exclusive, no-charge, royalty-free, irrevocable (except as stated in this section) patent license to make, have made, use, import, and otherwise transfer the Work.

Restrictions. The license granted in Section 3 above is expressly made subject to and limited by the following restrictions:

You agree not to remove any of the original copyright, patent, trademark, and attribution notices and associated disclaimers that may appear in the Source Code or Executable Files.

You agree not to advertise or in any way imply that this Work is a product of Your own.

The name of the Author may not be used to endorse or promote products derived from the Work without the prior written consent of the Author.

You agree not to sell, lease, or rent any part of the Work. This does not restrict you from including the Work or any part of the Work inside a larger software distribution that itself is being sold. The Work by itself, though, cannot be sold, leased or rented.

You may distribute the Executable Files and Source Code only under the terms of this License, and You must include a copy of, or the Uniform Resource Identifier for, this License with every copy of the Executable Files or Source Code You distribute and ensure that anyone receiving such Executable Files and Source Code agrees that the terms of this License apply to such Executable Files and/or Source Code. You may not offer or impose any terms on the Work that alter or restrict the terms of this License or the recipients' exercise of the rights granted hereunder. You may not sublicense the Work. You must keep intact all notices that refer to this License and to the disclaimer of warranties. You may not distribute the Executable Files or Source Code with any technological measures that control access or use of the Work in a manner inconsistent with the terms of this License.

You agree not to use the Work for illegal, immoral or improper purposes, or on pages containing illegal, immoral or improper material. The Work is subject to applicable export laws. You agree to comply with all such laws and regulations that may apply to the Work after Your receipt of the Work.

Representations, Warranties and Disclaimer. THIS WORK IS PROVIDED "AS IS", "WHERE IS" AND "AS AVAILABLE", WITHOUT ANY EXPRESS OR IMPLIED WARRANTIES OR CONDITIONS OR GUARANTEES. YOU, THE USER, ASSUME ALL RISK IN ITS USE, INCLUDING COPYRIGHT INFRINGEMENT, PATENT INFRINGEMENT, SUITABILITY, ETC. AUTHOR EXPRESSLY DISCLAIMS ALL EXPRESS, IMPLIED OR STATUTORY WARRANTIES OR CONDITIONS, INCLUDING WITHOUT LIMITATION, WARRANTIES OR CONDITIONS OF MERCHANTABILITY, MERCHANTABLE QUALITY OR FITNESS FOR A PARTICULAR PURPOSE, OR ANY WARRANTY OF TITLE OR NON-INFRINGEMENT, OR THAT THE WORK (OR ANY PORTION THEREOF) IS CORRECT, USEFUL, BUG-FREE OR FREE OF VIRUSES. YOU MUST PASS THIS DISCLAIMER ON WHENEVER YOU DISTRIBUTE THE WORK OR DERIVATIVE WORKS.

Indemnity. You agree to defend, indemnify and hold harmless the Author and the Publisher from and against any claims, suits, losses, damages, liabilities, costs, and expenses (including reasonable legal or attorneys' fees) resulting from or relating to any use of the Work by You.

Limitation on Liability. EXCEPT TO THE EXTENT REQUIRED BY APPLICABLE LAW, IN NO EVENT WILL THE AUTHOR OR THE PUBLISHER

BE LIABLE TO YOU ON ANY LEGAL THEORY FOR ANY SPECIAL, INCIDENTAL, CONSEQUENTIAL, PUNITIVE OR EXEMPLARY DAMAGES ARISING OUT OF THIS LICENSE OR THE USE OF THE WORK OR OTHERWISE, EVEN IF THE AUTHOR OR THE PUBLISHER HAS BEEN ADVISED OF THE POSSIBILITY OF SUCH DAMAGES.

Termination.

This License and the rights granted hereunder will terminate automatically upon any breach by You of any term of this License. Individuals or entities who have received Derivative Works from You under this License, however, will not have their licenses terminated provided such individuals or entities remain in full compliance with those licenses. Sections 1, 2, 6, 7, 8, 9, 10 and 11 will survive any termination of this License.

If You bring a copyright, trademark, patent or any other infringement claim against any contributor over infringements You claim are made by the Work, your License from such contributor to the Work ends automatically.

Subject to the above terms and conditions, this License is perpetual (for the duration of the applicable copyright in the Work). Notwithstanding the above, the Author reserves the right to release the Work under different license terms or to stop distributing the Work at any time; provided, however that any such election will not serve to withdraw this License (or any other license that has been, or is required to be, granted under the terms of this License), and this License will continue in full force and effect unless terminated as stated above.

Publisher. The parties hereby confirm that the Publisher shall not, under any circumstances, be responsible for and shall not have any liability in respect of the subject matter of this License. The Publisher makes no warranty whatsoever in connection with the Work and shall not be liable to You or any party on any legal theory for any damages whatsoever, including without limitation any general, special, incidental or consequential damages arising in connection to this license. The Publisher reserves the right to cease making the Work available to You at any time without notice

Miscellaneous

This License shall be governed by the laws of the location of the head office of the Author or if the Author is an individual, the laws of location of the principal place of residence of the Author.

If any provision of this License is invalid or unenforceable under applicable law, it shall not affect the validity or enforceability of the remainder of the terms of this License, and without further action by the parties to this License, such provision shall be reformed to the minimum extent necessary to make such provision valid and enforceable.

No term or provision of this License shall be deemed waived and no breach consented to unless such waiver or consent shall be in writing and signed by the party to be charged with such waiver or consent. This License constitutes the entire agreement between the parties with respect to the Work licensed herein. There are no understandings, agreements or representations with respect to the Work not specified herein. The Author shall not be bound by any additional provisions that may appear in any communication from You. This License may not be modified without the mutual written agreement of the Author and You

## libogg

<http://www.xiph.org/ogg/>

Copyright (c) 2002, Xiph.org Foundation

Redistribution and use in source and binary forms, with or without modification, are permitted provided that the following conditions are met:

Redistributions of source code must retain the above copyright notice, this list of conditions and the following disclaimer.

Redistributions in binary form must reproduce the above copyright notice, this list of conditions and the following disclaimer in the documentation and/or other materials provided with the distribution. Neither the name of the Xiph.org Foundation nor the names of its contributors may be used to endorse or promote products derived from this software without specific prior written permission.

THIS SOFTWARE IS PROVIDED BY THE COPYRIGHT HOLDERS AND CONTRIBUTORS "AS IS" AND ANY EXPRESS OR IMPLIED WARRANTIES, INCLUDING, BUT NOT LIMITED TO, THE IMPLIED WARRANTIES OF MERCHANTABILITY AND FITNESS FOR A PARTICULAR PURPOSE ARE DISCLAIMED. IN NO EVENT SHALL THE FOUNDATION OR CONTRIBUTORS BE LIABLE FOR ANY DIRECT, INDIRECT, INCIDENTAL, SPECIAL, EXEMPLARY, OR CONSEQUENTIAL DAMAGES (INCLUDING, BUT NOT LIMITED TO, PROCUREMENT OF SUBSTITUTE GOODS OR SERVICES; LOSS OF USE, DATA, OR PROFITS; OR BUSINESS INTERRUPTION) HOWEVER CAUSED AND ON ANY THEORY OF LIABILITY, WHETHER IN CONTRACT, STRICT LIABILITY, OR TORT (INCLUDING NEGLIGENCE OR OTHERWISE) ARISING IN ANY WAY OUT OF THE USE OF THIS SOFTWARE, EVEN IF ADVISED OF THE POSSIBILITY OF SUCH DAMAGE.

## libvorbis

<http://www.xiph.org/vorbis/>

Copyright (c) 2002-2004 Xiph.org Foundation

Redistribution and use in source and binary forms, with or without modification, are permitted provided that the following conditions are met:

Redistributions of source code must retain the above copyright notice, this list of conditions and the following disclaimer.

Redistributions in binary form must reproduce the above copyright notice, this list of conditions and the following disclaimer in the documentation and/or other materials provided with the distribution. Neither the name of the Xiph.org Foundation nor the names of its contributors may be used to endorse or promote products derived from this software without specific prior written permission.

THIS SOFTWARE IS PROVIDED BY THE COPYRIGHT HOLDERS AND CONTRIBUTORS "AS IS" AND ANY EXPRESS OR IMPLIED WARRANTIES, INCLUDING, BUT NOT LIMITED TO, THE IMPLIED WARRANTIES OF MERCHANTABILITY AND FITNESS FOR A PARTICULAR PURPOSE ARE DISCLAIMED. IN NO EVENT SHALL THE FOUNDATION OR CONTRIBUTORS BE LIABLE FOR ANY DIRECT, INDIRECT, INCIDENTAL, SPECIAL, EXEMPLARY, OR CONSEQUENTIAL DAMAGES (INCLUDING, BUT NOT LIMITED TO, PROCUREMENT OF SUBSTITUTE GOODS OR SERVICES; LOSS OF USE, DATA, OR PROFITS; OR BUSINESS INTERRUPTION) HOWEVER CAUSED AND ON ANY THEORY OF LIABILITY, WHETHER IN CONTRACT, STRICT LIABILITY, OR TORT (INCLUDING NEGLIGENCE OR OTHERWISE) ARISING IN ANY WAY OUT OF THE USE OF THIS SOFTWARE, EVEN IF ADVISED OF THE POSSIBILITY OF SUCH DAMAGE.

## Tremolo

<http://wss.co.uk/pinknoise/tremolo>

Copyright (C) 2002-2009 Xiph.org Foundation Changes Copyright (C) 2009-2010 Robin Watts for Pinknoise Productions Ltd

Redistribution and use in source and binary forms, with or without modification, are permitted provided that the following conditions are met:

– Redistributions of source code must retain the above copyright notice, this list of conditions and the following disclaimer.

– Redistributions in binary form must reproduce the above copyright notice, this list of conditions and the following disclaimer in the documentation and/or other materials provided with the distribution.

– Neither the name of the Xiph.org Foundation nor the names of its contributors may be used to endorse or promote products derived from this software without specific prior written permission.

THIS SOFTWARE IS PROVIDED BY THE COPYRIGHT HOLDERS AND CONTRIBUTORS "AS IS" AND ANY EXPRESS OR IMPLIED WARRANTIES, INCLUDING, BUT NOT LIMITED TO, THE IMPLIED WARRANTIES OF MERCHANTABILITY AND FITNESS FOR A PARTICULAR PURPOSE ARE DISCLAIMED. IN NO EVENT SHALL THE FOUNDATION OR CONTRIBUTORS BE LIABLE FOR ANY DIRECT, INDIRECT, INCIDENTAL, SPECIAL, EXEMPLARY, OR CONSEQUENTIAL DAMAGES (INCLUDING, BUT NOT LIMITED TO, PROCUREMENT OF SUBSTITUTE GOODS OR SERVICES; LOSS OF USE, DATA, OR PROFITS; OR BUSINESS INTERRUPTION) HOWEVER CAUSED AND ON ANY THEORY OF LIABILITY, WHETHER IN CONTRACT, STRICT LIABILITY, OR TORT (INCLUDING NEGLIGENCE OR OTHERWISE) ARISING IN ANY WAY OUT OF THE USE OF THIS SOFTWARE, EVEN IF ADVISED OF THE POSSIBILITY OF SUCH DAMAGE.

## Tremor

<http://wiki.xiph.org/index.php/Tremor>

Copyright (c) 2002, Xiph.org Foundation

Redistribution and use in source and binary forms, with or without modification, are permitted provided that the following conditions are met:

– Redistributions of source code must retain the above copyright notice, this list of conditions and the following disclaimer.

– Redistributions in binary form must reproduce the above copyright notice, this list of conditions and the following disclaimer in the documentation and/or other materials provided with the distribution.

– Neither the name of the Xiph.org Foundation nor the names of its contributors may be used to endorse or promote products derived from this software without specific prior written permission.

THIS SOFTWARE IS PROVIDED BY THE COPYRIGHT HOLDERS AND CONTRIBUTORS "AS IS" AND ANY EXPRESS OR IMPLIED WARRANTIES, INCLUDING, BUT NOT LIMITED TO, THE IMPLIED WARRANTIES OF MERCHANTABILITY AND FITNESS FOR A PARTICULAR PURPOSE ARE DISCLAIMED. IN NO EVENT SHALL THE FOUNDATION OR CONTRIBUTORS BE LIABLE FOR ANY DIRECT, INDIRECT, INCIDENTAL, SPECIAL, EXEMPLARY, OR CONSEQUENTIAL DAMAGES (INCLUDING, BUT NOT LIMITED TO, PROCUREMENT OF SUBSTITUTE GOODS OR SERVICES; LOSS OF USE, DATA, OR PROFITS; OR BUSINESS INTERRUPTION) HOWEVER CAUSED AND ON ANY THEORY OF LIABILITY, WHETHER IN CONTRACT, STRICT LIABILITY, OR TORT (INCLUDING NEGLIGENCE OR OTHERWISE) ARISING IN ANY WAY OUT OF THE USE OF THIS SOFTWARE, EVEN IF ADVISED OF THE POSSIBILITY OF SUCH DAMAGE.

## Mersenne Twister

<http://www.math.sci.hiroshima-u.ac.jp/~m-mat/MT/MT2002/CODES/mt19937ar.c>

Copyright (C) 1997 - 2002, Makoto Matsumoto and Takuji Nishimura, All rights reserved.

Redistribution and use in source and binary forms, with or without modification, are permitted provided that the following conditions are met:

Redistributions of source code must retain the above copyright notice, this list of conditions and the following disclaimer.

Redistributions in binary form must reproduce the above copyright notice, this list of conditions and the following disclaimer in the documentation and/or other materials provided with the distribution. The names of its contributors may not be used to endorse or promote products derived from this software without specific prior written permission.

THIS SOFTWARE IS PROVIDED BY THE COPYRIGHT HOLDERS AND CONTRIBUTORS "AS IS" AND ANY EXPRESS OR IMPLIED WARRANTIES, INCLUDING, BUT NOT LIMITED TO, THE IMPLIED WARRANTIES OF MERCHANTABILITY AND FITNESS FOR A PARTICULAR PURPOSE ARE DISCLAIMED. IN NO EVENT SHALL THE COPYRIGHT OWNER OR CONTRIBUTORS BE LIABLE FOR ANY DIRECT, INDIRECT, INCIDENTAL, SPECIAL, EXEMPLARY, OR CONSEQUENTIAL DAMAGES (INCLUDING, BUT NOT LIMITED TO, PROCUREMENT OF SUBSTITUTE GOODS OR SERVICES; LOSS OF USE, DATA, OR PROFITS; OR BUSINESS INTERRUPTION) HOWEVER CAUSED AND ON ANY THEORY OF LIABILITY, WHETHER IN CONTRACT, STRICT LIABILITY, OR TORT (INCLUDING NEGLIGENCE OR OTHERWISE) ARISING IN ANY WAY OUT OF THE USE OF THIS SOFTWARE, EVEN IF ADVISED OF THE POSSIBILITY OF SUCH DAMAGE.

## zlib

<http://www.zlib.net/>

zlib.h -- interface of the 'zlib' general purpose compression library version 1.2.3, July 18th, 2005

Copyright (C) 1995-2004 Jean-loup Gailly and Mark Adler

This software is provided 'as-is', without any express or implied warranty. In no event will the authors be held liable for any damages arising from the use of this software.

Permission is granted to anyone to use this software for any purpose, including commercial applications, and to alter it and redistribute it freely, subject to the following restrictions:

The origin of this software must not be misrepresented; you must not claim that you wrote the original software. If you use this software in a product, an acknowledgment in the product documentation would be appreciated but is not required.

Altered source versions must be plainly marked as such, and must not be misrepresented as being the original software.

This notice may not be removed or altered from any source distribution.

Jean-loup Gailly [jloup@gzip.org](mailto:jloup@gzip.org), Mark Adler [madler@alumni.caltech.edu](mailto:madler@alumni.caltech.edu)

## curl

<http://curl.haxx.se>

COPYRIGHT AND PERMISSION NOTICE

Copyright (c) 1996 - 2011, Daniel Stenberg, <[daniel@haxx.se](mailto:daniel@haxx.se)>.

All rights reserved.

Permission to use, copy, modify, and distribute this software for any purpose with or without fee is hereby granted, provided that the above copyright notice and this permission notice appear in all copies.

THE SOFTWARE IS PROVIDED "AS IS", WITHOUT WARRANTY OF ANY KIND, EXPRESS OR IMPLIED, INCLUDING BUT NOT LIMITED TO THE WARRANTIES OF MERCHANTABILITY, FITNESS FOR A PARTICULAR PURPOSE AND NONINFRINGEMENT OF THIRD PARTY RIGHTS. IN NO EVENT SHALL THE AUTHORS OR COPYRIGHT HOLDERS BE LIABLE FOR ANY CLAIM, DAMAGES OR OTHER LIABILITY, WHETHER IN AN ACTION OF CONTRACT, TORT OR OTHERWISE, ARISING FROM, OUT OF OR IN CONNECTION WITH THE SOFTWARE OR THE USE OR OTHER DEALINGS IN THE SOFTWARE.

Except as contained in this notice, the name of a copyright holder shall not be used in advertising or otherwise to promote the sale, use or other dealings in this Software without prior written authorization of the copyright holder.

## C-ares

<http://c-ares.haxx.se>

Copyright 1998 by the Massachusetts Institute of Technology.

Permission to use, copy, modify, and distribute this software and its documentation for any purpose and without fee is hereby granted, provided that the above copyright notice appear in all copies and that both that copyright notice and this permission notice appear in supporting documentation, and that the name of M.I.T. not be used in advertising or publicity pertaining to distribution of the software without specific, written prior permission. M.I.T. makes no representations about the suitability of this software for any purpose. It is provided "as is" without express or implied warranty.

<http://www.sony.net/>



\* 4 5 3 3 0 9 2 1 2 \* (1)