

Application Software

Using Sound Forge Audio Studio LE

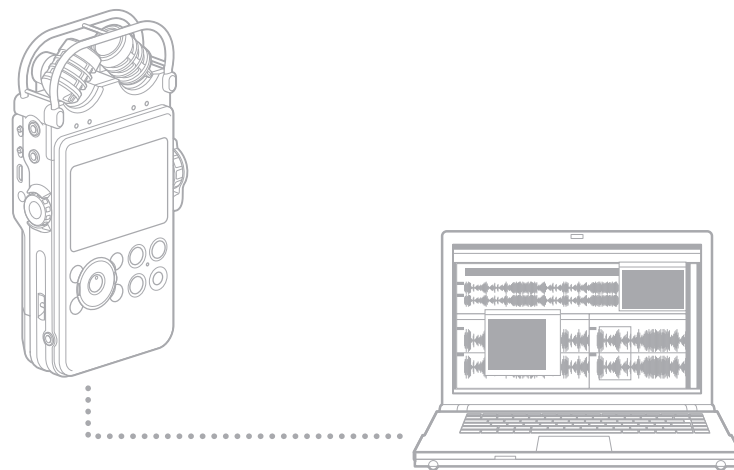

PCM-D100



What you can do with Sound Forge Audio Studio LE

Sound Forge Audio Studio LE allows you to play and edit audio files recorded with your linear PCM recorder, imported from an audio CD, downloaded from a website, or copied from your computer. You can also burn an audio CD and enjoy a variety of features available in Sound Forge Audio Studio LE.

Note

Sound Forge Audio Studio LE does not support nor handle a DSD (.dsf/.dff/.wsd) file. You can divide a file, combine files, and delete files using the linear PCM recorder. For detailed procedures, refer to the operating instructions.



Sound Forge is a trademark or registered trademark of Sony Creative Software, Inc. in the United States and other countries.

Step 1

Install Sound Forge Audio Studio LE on your computer

System requirements for Sound Forge Audio Studio LE

Operating systems

- Windows® XP 32 bit Service Pack 3 or higher
- Windows Vista® 32 bit or 64 bit Service Pack 2 or higher
- Windows® 7 32 bit or 64 bit
- Windows® 8 32 bit or 64 bit
- Windows® 8.1 32 bit or 64 bit

Note

One of the above operating systems should be by default pre-installed. Any operating system other than those indicated above, upgraded operating systems or multi-boot environment are not supported.

Hardware environment

- CPU: processor of 1 GHz or faster
- Free hard disk space: At least 350 MB (For software installation)
- Memory: At least 1 GB
- Sound board: Sound boards compatible with any of the supported operating systems
- Port: USB port
- Disk drive: DVD-ROM drive compatible with any of the supported operating systems (To create a music CD, you need a CD-R/RW drive.)
- Microsoft DirectX® 9.0c or higher
- Microsoft .NET Framework 2.0
- Internet connection

Installing Sound Forge Audio Studio LE

1 Insert the supplied installer DVD-ROM (“Sound Forge Audio Studio LE”) into the DVD-ROM drive of your running computer.

The setup window starts up automatically.

If the startup window does not appear automatically, open Windows Explorer, right-click the DVD-ROM drive, double-click [setup.exe], and then follow the instructions on the screen.

2 Click [Install Sound Forge Audio Studio].

If you want to change the language for menus and messages, select the desired language.



3 When the “Welcome to the Sound Forge Audio Studio 10.0 Installation Wizard” window appears, click [Next].



4 Read the statements in the END USER LICENSE AGREEMENT, check “I have read the End User License Agreement and the Privacy Policy and agree to their terms.,” and then click [Next].

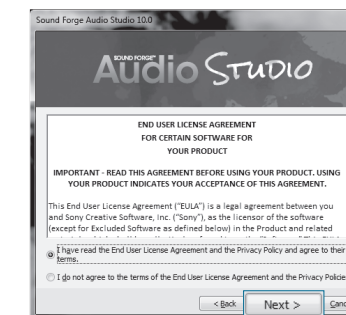

5 When the window to select the destination folder for installation appears, click [Install].

If you want to change the destination folder, click [Change] and select the desired folder. To start Sound Forge Audio Studio quickly from the desktop, check “Create a shortcut on the desktop.” The installation starts.

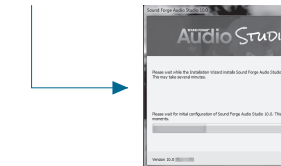
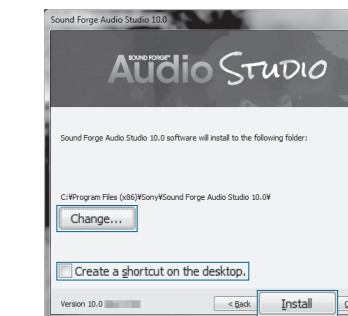

6 When the “Sound Forge Audio Studio 10.0 has been successfully installed.” window appears, click [Finish].

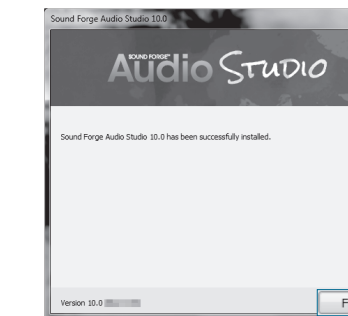

## Step 2 Start Sound Forge Audio Studio LE

- 1 Click [Start], and then click [All Programs] – [Sound Forge Audio Studio].

Sound Forge Audio Studio LE starts. When you start the software for the first time, the product registration window is displayed.



- 2 Click [Next].



- 3 When the product registration window is displayed, check "Register online", and then click [Next].



- 4 When the online registration window is displayed, enter your information for registration, and check "By providing this registration information, I acknowledge that I have read and agree with terms of the Sony Creative Software Inc. Privacy Policy.," then click [Finish].

The online registration starts. When it is completed, a confirmation message appears. Click [OK].

Sound Forge Audio Studio LE starts.

The tutorial window will start. You can select the desired operation and click to start the tutorial of the operation.

For details on the operations of Sound Forge Audio Studio LE, refer to the Help Guide of Sound Forge Audio Studio LE.

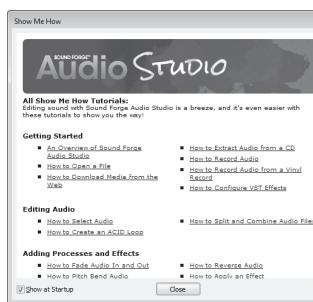

## Step 3 Copy and save files onto your computer

You can exchange files between your linear PCM recorder and your computer without using Sound Forge Audio Studio LE.

- 1 Connect your linear PCM recorder to a running computer using the USB cable (supplied).

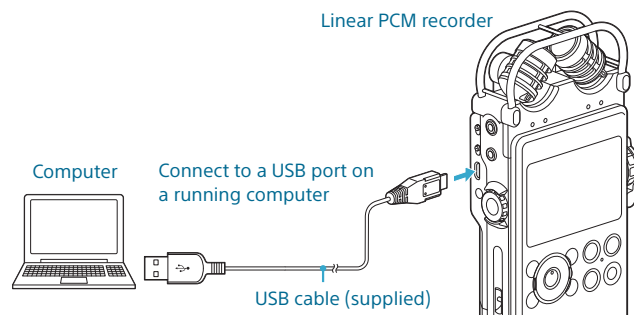

- 2 Make sure that your linear PCM recorder is recognized correctly by your computer.

In Windows: Open [Computer] (or [My computer]), and check that [PCMRECORDER] is recognized properly.

In Mac: Check that the [PCMRECORDER] drive is displayed in the Finder.

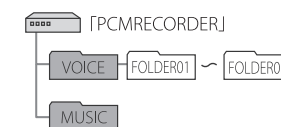

- 3 Copy files you want to transfer to your computer.

Drag and drop the files you want to copy from "PCMRECORDER" or "MEMORY CARD" to the local disk on your computer.

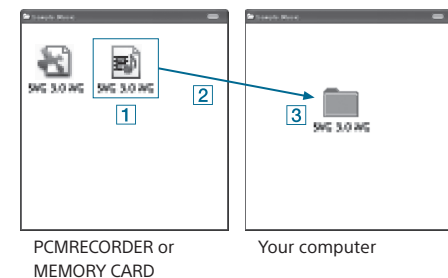

- 1 Click and hold,
- 2 drag,
- 3 and then drop.

- 4 Disconnect the PCM recorder from your computer.

Make sure that the ACCESS indicator on the linear PCM recorder is not lit and perform the following operation on your computer.

On Windows:

On the taskbar at the bottom right of the desktop, left-click the following icon:



Then left-click "Eject PCMRECORDER" (Windows 7, Windows 8) or "Safely remove USB Mass Storage Device" (Windows XP, Windows Vista).

The icon and menu displayed may be different depending on the operating system. The icon may not always be displayed on the taskbar depending on your computer settings.

On Mac:

Click the "PCMRECORDER" removal icon that appears on the sidebar of the Finder.

For details on the procedures to remove your linear PCM recorder from your computer, refer to the manual supplied with your computer.

## Importing audio files from a CD

- 1 Insert an audio CD into the CD-R/RW drive of your computer.

- 2 From the [File] menu, select [Extract Audio from CD].

- 3 When the "Extract Audio from CD" window appears, select [Read by track] from the "Action" drop-down list. Select the tracks you want to import in the "Tracks to extract" list box, and click [OK].

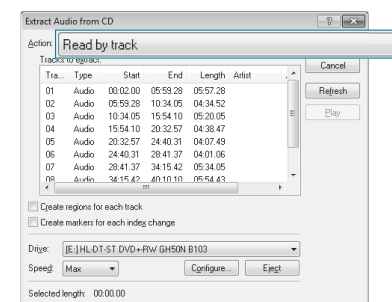

To import all of the tracks on a CD, select [Read entire disc].

The selected audio tracks are extracted to Sound Forge Audio Studio LE. To use the extracted tracks, select [Save] from the [File] menu.

## Step 4 Create an audio CD

You can create an audio CD from tracks registered in Sound Forge Audio Studio LE.

- 1 Open the files you want to burn to an audio CD.

Select the [Open] button on the toolbar or [Explorer] from the [View] menu, and open the desired files in the workspace of Sound Forge Audio Studio.

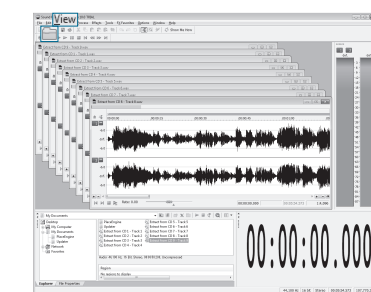

- 2 Insert a new CD-R/CD-RW disc into the CD-R/RW drive of your computer.

- 3 From the [Tool] menu, click [Burn Track-at-Once Audio CD].

- 4 When the "Burn Track-at-Once Audio CD" window is displayed, check "Close disc when done burning," and click [Start].

Burning of the audio CD starts. When it is completed, a confirmation message is displayed. Click [OK].

Tip

Closing the disc allows you to play files on an audio CD player.

Note

When you burn multiple files to an audio CD, check the "Close disc when done burning" only for the last file you burn. For the rest of files, make sure not to check the check box.

