

Mini Hi-Fi Component System

Operating Instructions

Owner's Record

The model and serial numbers are located on the rear of the unit. Record the serial number in the space provided below. Refer to them whenever you call upon your Sony dealer regarding this product.

Model No. _____

Serial No. _____



***MHC-GX750/GX450/GX250
MHC-RG555/RG551S/RG444S/
RG441/RG333/RG222/
RG221/RG121/RG100
MHC-RX550***

WARNING

To prevent fire or shock hazard, do not expose the unit to rain or moisture.

To prevent fire, do not cover the ventilation of the apparatus with news papers, table-cloths, curtains, etc. And don't place lighted candles on the apparatus.

To prevent fire or shock hazard, do not place objects filled with liquids, such as vases, on the apparatus.

Do not install the appliance in a confined space, such as a bookcase or built-in cabinet.

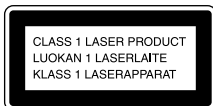

This appliance is classified as a CLASS 1 LASER product. This marking is located on the rear exterior.



Don't throw away the battery with general house waste, dispose of it correctly as chemical waste.

NOTICE FOR THE CUSTOMERS IN THE U.S.A.

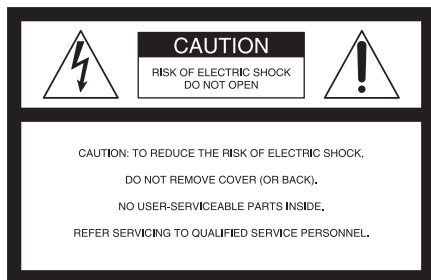

This symbol is intended to alert the user to the presence of uninsulated "dangerous voltage" within the product's enclosure that may be of sufficient magnitude to constitute a risk of electric shock to persons.



This symbol is intended to alert the user to the presence of important operating and maintenance (servicing) instructions in the literature accompanying the appliance.

CAUTION

The use of optical instruments with this product will increase eye hazard.

WARNING

This equipment has been tested and found to comply with the limits for a Class B digital device, pursuant to Part 15 of the FCC Rules. These limits are designed to provide reasonable protection against harmful interference in a residential installation. This equipment generates, uses, and can radiate radio frequency energy and, if not installed and used in accordance with the instructions, may cause harmful interference to radio communications. However, there is no guarantee that interference will not occur in a particular installation. If this equipment does cause harmful interference to radio or television reception, which can be determined by turning the equipment off and on, the user is encouraged to try to correct the interference by one or more of the following measures:

- Reorient or relocate the receiving antenna.
- Increase the separation between the equipment and receiver.
- Connect the equipment into an outlet on a circuit different from that to which the receiver is connected.
- Consult the dealer or an experienced radio/TV technician for help.

CAUTION

You are cautioned that any changes or modifications not expressly approved in this manual could void your authority to operate this equipment.

Note to CATV system installer:

This reminder is provided to call the CATV system installer's attention to Article 820-40 of the NEC that provides guidelines for proper grounding and, in particular, specifies that the cable ground shall be connected to the grounding system of the building, as close to the point of cable entry as practical.

NOTICE FOR THE CUSTOMERS IN CANADA

CAUTION

TO PREVENT ELECTRIC SHOCK, MATCH WIDE BLADE OF PLUG TO WIDE SLOT, FULLY INSERT.

CAUTION

The use of optical instruments with this product will increase eye hazard.

NOTICE FOR THE CUSTOMERS IN THE
U.S.A. (MHC-GX750 only)

If you have any questions about this product, you may call;

Sony Customer Information Service Center
1-800-222-7669 or <http://www.sony.com/>

The Number below is for the FCC related matters only.

Regulatory Information

Declaration of Conformity

Trade Name: SONY

Model No.: HCD-GX750

Responsible Party: Sony Electronics Inc.

Address: 16450 W. Bernardo Dr, San
Diego, CA 92127 U.S.A.

Telephone No.: 858-942-2230

This device complies with Part 15 of the FCC Rules.

Operation is subject to the following two conditions: (1) This device may not cause harmful interference, and (2) this device must accept any interference received, including interference that may cause undesired operation.

NOTICE FOR THE CUSTOMERS IN THE
CANADA (MHC-GX750 only)

Operation is subject to the following two conditions:
(1) this device may not cause interference, and (2) this device must accept any interference, including interference that may cause undesired operation of the device.

Son utilisation est autorisée seulement aux conditions suivantes: (1) il ne doit pas produire de brouillage et (2) l'utilisateur du dispositif doit être prêt à accepter tout brouillage radioélectrique reçu, même si ce brouillage est susceptible de compromettre le fonctionnement du dispositif.

NOTICE FOR THE CUSTOMERS IN THE
U.S.A AND CANADA (MHC-GX750 only)

Replace the AC power adaptor with model AC-GSX100 only, if replacement is necessary.

Except for European model



ENERGY STAR[®] is a U.S. registered mark. As an ENERGY STAR[®] partner, Sony Corporation has determined that this product meets the ENERGY STAR[®] guidelines for energy efficiency.

Table of Contents

How to use this manual.....	5	Selecting the surround effect.....	23
Playable discs.....	5	Enhancing video game sound.....	23
<hr/>		— Game Sync	
Getting Started		Mixing video game sound with other sound source.....	23
Hooking up the system.....	7	— Game Mixing	
Setting the clock.....	10	Singing along.....	24
<hr/>		(MHC-RG555 only)	
CD/MP3 – Play		<hr/>	
Loading a disc.....	11	Timer	
Playing a disc.....	11	Falling asleep to music.....	25
— Normal Play/Shuffle Play		— Sleep Timer	
Playing repeatedly.....	13	Waking up to music.....	25
— Repeat Play		— Play Timer	
Creating your own program.....	14	Timer recording radio programs.....	26
— Program Play		— Rec Timer	
<hr/>		<hr/>	
Tuner		Display	
Presetting radio stations.....	15	Turning off the display.....	27
Listening to the radio.....	16	— Power Saving Mode	
— Preset Tuning		Viewing information about the disc in the display.....	28
— Manual Tuning		Changing the Power illuminator.....	28
Using the Radio Data System (RDS)....	17	(MHC-GX750/GX450/RG555/ RG551S/RG444S/RG441/ RG333/RX550 only)	
(European model only)		<hr/>	
<hr/>		Optional Components	
Tape – Play		Hooking up optional components.....	29
Loading a tape.....	18	Transmitter.....	30
Playing a tape.....	18	(MHC-GX750 only)	
<hr/>		<hr/>	
Tape – Recording		Troubleshooting	
Recording your favorite CD tracks on a tape.....	19	Problems and remedies.....	33
— CD-TAPE Synchro Recording		Messages.....	36
Recording on a tape manually.....	20	<hr/>	
— Manual Recording		Additional Information	
<hr/>		Precautions.....	37
Sound Adjustment		Specifications.....	38
Adjusting the sound.....	21	List of button locations and reference pages.....	44
Using the sub woofer.....	21	<hr/>	
(MHC-GX750/GX450/RG551S/ RG444S/RX550 only)			
Selecting the sound effect.....	22		
Adjusting the graphic equalizer and storing.....	22		





How to use this manual

This manual mainly explains operations using the remote, but the same operations can also be performed using the buttons on the unit having the same or similar names.

Playable discs

You can play back the following discs on this system. Other discs cannot be played back.

List of playable discs

Format of discs	Disc logo
Audio CDs	
CD-R/CD-RW (audio data/MP3 files*)	   

* MHC-GX750/GX450/RG555/RG551S/RG444S/RG441/RG333/RG222/RG221/RX550 only

Discs that this system cannot play

- CD-ROMs
- CD-Rs/CD-RWs other than those recorded in the following formats:
 - music CD format
 - MP3 format that conforms to ISO9660¹⁾ Level 1/Level 2, Joliet or Multi Session²⁾
- A disc that has a non-standard shape (e.g., card, heart).
- A disc with paper or stickers on it.
- A disc that has the adhesive, cellophane tape, or a sticker still left on it.

1) ISO9660 Format

The most common international standard for the logical format of files and folders on a CD-ROM. There are several specification levels. In Level 1, file names must be in the 8.3 format (no more than eight characters in the name, no more than three characters in the extension “.MP3”) and in capital letters. Folder names can be no longer than eight characters. There can be no more than eight nested folder levels. Level 2 specifications allow file names and folder names up to 31 characters long. Each folder can have up to 8 trees.

For Joliet in the expansion format (file and folder names can have up to 64 characters) make sure of the contents of the writing software, etc.

2) Multi Session

This is a recording method that enables adding of data using the Track-At-Once method.

Conventional CDs begin at a CD control area called the Lead-in and end at an area called Lead-out. A Multi Session CD is a CD having multiple sessions, with each segment from Lead-in to Lead-out regarded as a single session.

CD-Extra: This format records audio (audio CD data) on the tracks in session 1 and data on the tracks in session 2.

Mixed CD: This format records data on the first track and audio (audio CD data) on the second and subsequent tracks of a session.

Notes on CD-R and CD-RW

- Some CD-Rs or CD-RWs cannot be played on this system depending upon the recording quality or physical condition of the disc, or the characteristics of the recording device. Furthermore, the disc will not play if it has not been correctly finalized. For more information, see the operating instructions for the recording device.
- Discs recorded on CD-R/CD-RW drives may not be played back because of scratches, dirt, recording condition or the driver's characteristics.
- CD-R and CD-RW discs recorded in multi-session that have not ended by "closing the session" are not supported.
- The system may be unable to play MP3 format files that do not have the ".MP3" extension.
- Attempting to play non-MP3 format files that have the ".MP3" extension may result in noise or malfunction.
- With formats other than ISO9660 level 1 and 2, folder names or file names may not be displayed correctly.
- The following discs take a longer time to start playback.
 - a disc recorded with complicated tree structure.
 - a disc recorded in Multi Session.
 - a disc to which data can be added (non-finalized disc).

Music discs encoded with copyright protection technologies

This product is designed to playback discs that conform to the Compact Disc (CD) standard. Recently, various music discs encoded with copyright protection technologies are marketed by some record companies. Please be aware that among those discs, there are some that do not conform to the CD standard and may not be playable by this product.

Cautions when playing a disc that is recorded in Multi Session

- If the disc begins with a CD-DA session, it is recognized as a CD-DA (audio) disc, and playback continues until an MP3 session is encountered.
- If the disc begins with an MP3 session, it is recognized as an MP3 disc, and playback continues until a CD-DA (audio) session is encountered.
- The playback range of an MP3 disc is determined by the tree structure of files produced by analyzing of the disc.
- A disc with a mixed CD format will be recognized as a CD-DA (audio) disc.

Hooking up the system

Perform the following procedures **1** to **5** to hook up your system using the supplied cords and accessories. A model equipped with a sub woofer is used for illustration purpose.

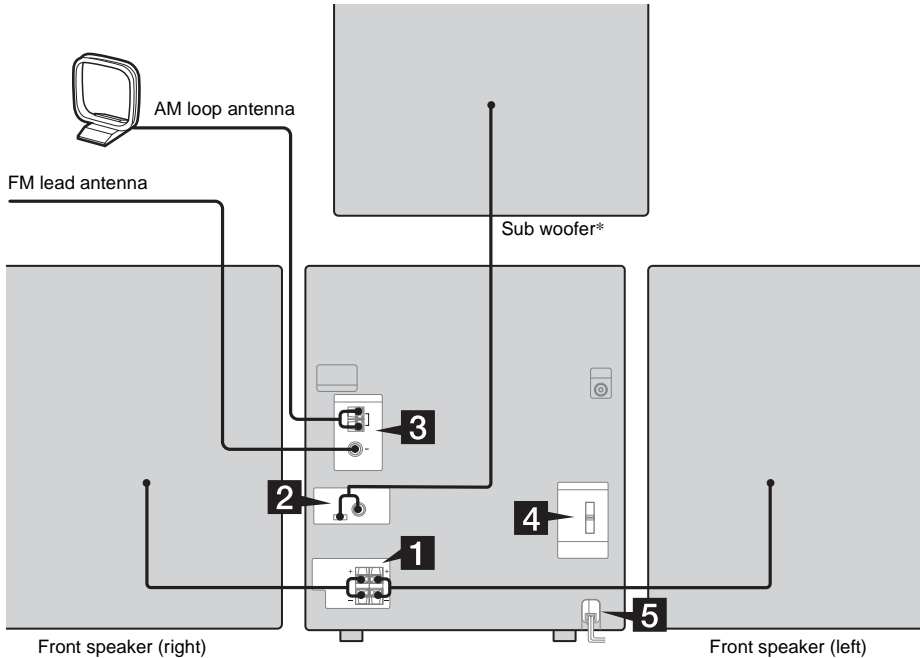

* MHC-GX750/GX450/RG551S/RG444S/RX550 only

1 Connect the front speakers.

Connect the right and left speaker cords to the SPEAKER terminals as shown below.

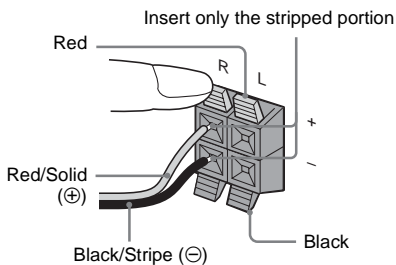

2 Connect the sub woofer. (MHC-GX750/GX450/RG551S/RG444S/ RX550 only)

Connect the speaker cords to the SUB WOOFER OUT jack and CONTROL jack as shown below.

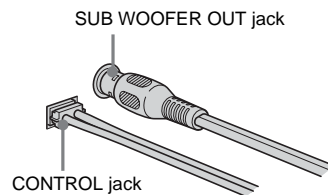

3 Connect the FM and AM antennas.

Set up the AM loop antenna, then connect it.

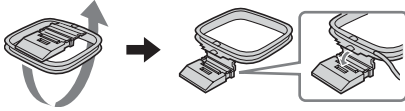

Plug type Ⓐ

AM loop antenna

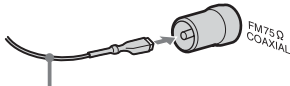
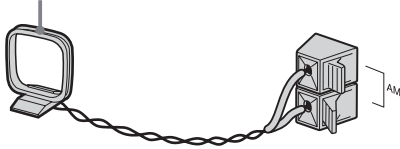

Extend the FM lead antenna horizontally

Plug type Ⓑ

AM loop antenna

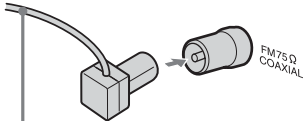

Extend the FM lead antenna horizontally

Plug type Ⓒ

AM loop antenna

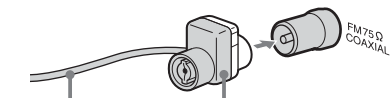
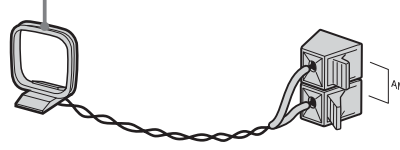

Extend the FM lead antenna horizontally

North American model:
Connect white side.
Other models:
Connect brown side.

Note

Keep the antennas away from the speaker cords.

4 For models with a voltage selector, set VOLTAGE SELECTOR to the local power line voltage.

Refer to the print on your system's VOLTAGE SELECTOR for available settings.

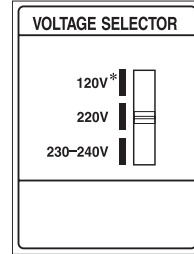

* Saudi Arabian model: 120 – 127 V

5 Connect the power cord to a wall outlet.

The demonstration appears in the display. When you press I/⏻, the system turns on and the demonstration automatically ends. If the plug does not fit the wall socket, detach the supplied plug adaptor (only for models equipped with an adaptor).

Inserting two R6 (size AA) batteries into the remote

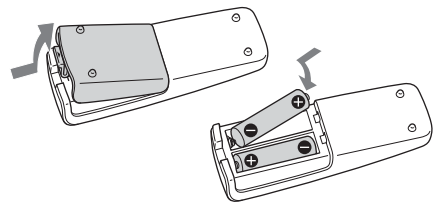

Note

If you do not use the remote for a long period of time, remove the batteries to avoid possible damage from battery leakage and corrosion.

Tip

With normal use, the batteries should last for about six months. When the remote no longer operates the system, replace both batteries with new ones.

Attaching the front speaker pads

Attach the supplied speaker pads to the bottom of the speakers to stabilize the speakers and prevent them from slipping.

Front speaker (Left (4)/Right (4))

Sub woofer (4)*

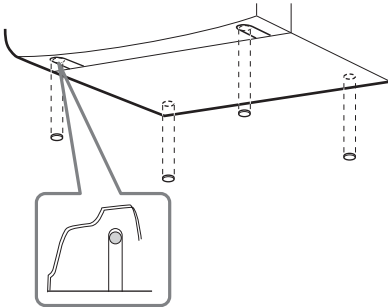

* MHC-GX750/GX450/RG551S/RG444S/RX550 only

When carrying this system

Perform the following procedure to protect the CD mechanism. Use buttons on the unit for the operation.

- 1 Make sure that all discs are removed from the system.
- 2 Hold down CD and then press I/⏻ until "STANDBY" appears.
After a few seconds later, "STANDBY" disappears and "LOCK" appears.
- 3 Unplug the power cord.

Placing the sub woofer (MHC-GX750/GX450/RG551S/RG444S/RX550 only)

To obtain a better bass reproduction, we recommend you to place the sub woofer on a solid floor where resonance is unlikely to occur.

Notes

- Always place the sub woofer vertically, keeping it a few centimeters away from the wall.
- If the sub woofer is placed in the center of a room, the bass could be extremely weakened. This is due to the influence of the standing wave of the room. If this happens, move the sub woofer away from the center of the room or eliminate the cause of the standing wave, by placing a bookshelf against the wall, etc.

Setting the clock

Use buttons on the remote for the operation.

- 1** Press I/⏻ to turn on the system.
- 2** Press CLOCK/TIMER SET.
- 3** Press I◀◀ or ▶▶I repeatedly to set the hour.
- 4** Press ENTER.
- 5** Press I◀◀ or ▶▶I repeatedly to set the minute.
- 6** Press ENTER.

The clock starts working.

To adjust the clock

- 1** Press CLOCK/TIMER SET.
- 2** Press I◀◀ or ▶▶I repeatedly to select "CLOCK SET", then press ENTER.
- 3** Do the same procedures as step 3 to 6 above.

Notes

- The clock settings are canceled when you disconnect the power cord or if a power failure occurs.
- You cannot set the clock in Power Saving Mode (page 27).

Loading a disc

Use buttons on the unit for the operation.

- 1 Press **▲**.
- 2 Place a disc with the label side up on the disc tray.

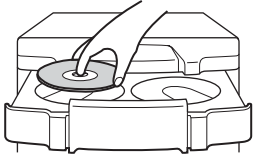

To insert additional discs, press DISC SKIP/EX-CHANGE to rotate the disc tray.

- 3 Press **▲** again to close the disc tray.

Notes

- Do not use a disc with tape, seals or paste on it as this may cause malfunction.
- Do not forcibly press the disc tray closed with your finger, as this may cause malfunction.

Playing a disc

— Normal Play/Shuffle Play

This system lets you play audio CDs and discs with MP3 audio tracks.

MP3 audio tracks cannot be played on MHC-GX250, MHC-RG121 and MHC-RG100.

Example: When a disc is loaded

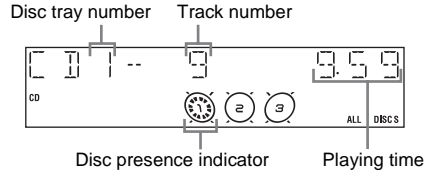

- 1 Press **CD** (or **FUNCTION** repeatedly) to switch the function to CD.

2 Press **PLAY MODE** repeatedly in stop mode until the mode you want appears in the display.

Select	To play
ALL DISCS (Normal Play)	All discs in the disc tray continuously.
1DISC (Normal Play)	The tracks on the disc you have selected in original order.
ALBM (Normal Play)	All MP3 audio tracks in the album on the disc you have selected in original order. When playing a non-MP3 disc, Album Play performs the same operation as 1DISC Play.
ALL DISCS SHUF (Shuffle Play)	The tracks on all discs in random order.
1DISC SHUF (Shuffle Play)	The tracks on the disc you have selected in random order.
ALBM SHUF (Shuffle Play)	The MP3 audio tracks in the album on the disc you have selected in random order. When playing a non-MP3 disc, Album Shuffle Play performs the same operation as 1DISC SHUF Play.
PGM (Program Play)	The tracks on the disc in the order you want them to be played (see "Creating your own program" on page 14).

3 Press **▶**.

Other operations

To	Do this
Stop play	Press ■ .
Pause	Press ⏸ . Press again to resume play.
Select a track	Press ⏮ or ⏭ repeatedly (or turn ⏮ ⏭ on the unit).
Select an album of MP3	Press ALBUM - or + repeatedly after step 2.
Find a point in a track*	Keep pressing ⏮ or ⏭ during playback and release it at the desired point.
Select a disc in stop mode	Press DISC SKIP (or DISC 1 - 3 or DISC SKIP/EX-CHANGE on the unit).
Switch to CD function from other function	Press DISC 1 - 3 on the unit (Automatic Source Selection).
Exchange other discs while playing	Press DISC SKIP/EX-CHANGE on the unit.
Remove a disc	Press ▲ on the unit.

* You may not be able to search between multiple files. Also, the time may not be displayed correctly for some files.

Notes

- You cannot change the play mode during playback.
- Some time may be needed to start playback of discs recorded in complex configurations such as many layers.
- When the disc is inserted, the player reads all the tracks on that disc. If there are many albums or non-MP3 audio tracks on the disc, it may take a long time for play to begin or for the next MP3 audio track to start play.
- Do not save unnecessary albums or tracks other than MP3 ones in the disc to be used for MP3 listening. We recommend that you do not save other types of tracks or unnecessary albums on a disc that has MP3 audio tracks.
- An album that does not include an MP3 audio track is skipped.
- Maximum album number: 150 (including root folder)
- The maximum number of MP3 audio tracks and albums that can be contained on a single disc is 255.
- Playback is possible up to 8 levels.
- MP3 audio tracks are played back in the order that they are recorded on the disc.
- Depending on the encoding/writing software, recording device, or the recording media used at the time an MP3 audio track is recorded, you may encounter such problems as disabled playback, sound interruptions, and noise.

Playing repeatedly

— Repeat Play

You can play all the tracks or a single track on a disc repeatedly.

MP3 audio tracks cannot be played on MHC-GX250, MHC-RG121 and MHC-RG100.

Press REPEAT until “REP” or “REP1” appears.

REP: For all the tracks on a disc up to five times.

REP1: For a single track only.

To cancel Repeat Play

Press REPEAT repeatedly until both “REP” and “REP1” disappear.

Notes

- You cannot select “REP” and “ALL DISCS SHUF” at the same time.
- When you select “REP1”, that track is repeated endlessly until “REP1” is canceled.

Creating your own program

— Program Play

You can make a program of up to 25 steps from all the discs in the order you want to play them. You can synchro record the programmed tracks onto a cassette tape (page 19).

MP3 audio tracks cannot be played on MHC-GX250, MHC-RG121 and MHC-RG100.

1 Press CD (or FUNCTION repeatedly) to switch the function to CD.

2 Press PLAY MODE repeatedly in stop mode until “PGM” appears.

3 Press DISC SKIP (or DISC 1 – 3 or DISC SKIP/EX-CHANGE on the unit) to select a disc.

4 Press ◀◀ or ▶▶ repeatedly (or turn ◀◀ ▶▶ on the unit) until the desired track number appears.

When programming the MP3 audio tracks, press ALBUM – or + to select album, then press ◀◀ or ▶▶ repeatedly (or turn ◀◀ ▶▶ on the unit) until the desired track number appears.

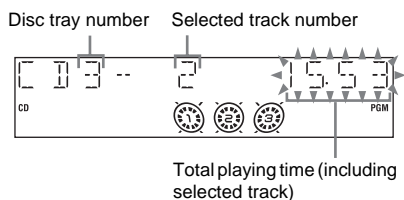

5 Press ENTER.

The track is programmed.

The program step number appears, followed by the total playing time.

6 Program additional tracks.

To program	Repeat steps
Other tracks on the same disc	4 and 5
Other tracks on other discs	3 to 5

7 Press ▶.

Program Play starts.

Other operations

To	Do this
Cancel Program Play	Press PLAY MODE repeatedly in stop mode until “PGM” disappears.
Clear a track from the end	Press CLEAR in stop mode.

Tips

- The program you made remains after Program Play finishes. To play the same program again, press CD (or FUNCTION repeatedly) to switch the function to CD, then press ▶. However, the program is cleared when you open the disc tray.
- “- - - -” appears when the total CD program time exceeds 100 minutes, or when you select a CD track whose number is 21 or over, or when you select an MP3 audio track.

Presetting radio stations

You can preset up to 20 FM stations and 10 AM stations. You can then tune in any of those stations simply by selecting the corresponding preset number.

Automatic tuning preset

You can automatically tune in all of the stations that can be received in your area and then store the radio frequency of the desired stations.

- 1** Press **TUNER BAND** (or **FUNCTION** repeatedly) to switch the function to tuner.
- 2** Press **TUNER BAND** repeatedly to select “FM” or “AM”.
- 3** Press **TUNING MODE** repeatedly until “AUTO” appears in the display.
- 4** Press **– or +** (or **TUNING – or +** on the unit).

The frequency changes as the system scans for a station. Scanning stops automatically when a station is tuned in. At that time, “TUNED” and “STEREO” (for an FM stereo program) appear.

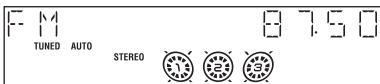

If “TUNED” does not appear and the scanning does not stop

Set the frequency of the desired radio station as described in steps 3 through 8 of “Manual tuning preset” (page 15).

- 5** Press **TUNER MEMORY**.

A preset number appears.

Preset number

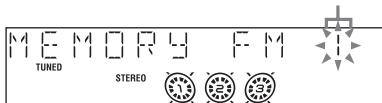

- 6** Press **– or +** (or **TUNING – or +** on the unit) repeatedly to select the desired preset number.

- 7** Press **ENTER**.

- 8** Repeat steps 2 through 7 to store other stations.

Manual tuning preset

You can manually tune in and store the radio frequency of the desired stations.

- 1** Press **TUNER BAND** (or **FUNCTION** repeatedly) to switch the function to tuner.
- 2** Press **TUNER BAND** repeatedly to select “FM” or “AM”.
- 3** Press **TUNING MODE** repeatedly until “AUTO” and “PRESET” disappear from the display.
- 4** Press **– or +** (or **TUNING – or +** on the unit) repeatedly to tune in the desired station.
- 5** Press **TUNER MEMORY**.
A preset number appears.
- 6** Press **– or +** (or **TUNING – or +** on the unit) repeatedly to select the desired preset number.
- 7** Press **ENTER**.
- 8** Repeat steps 2 through 7 to store other stations.

Other operations

To	Do this
Tune in a station with a weak signal	Follow the procedure described in “Manual tuning preset” (page 15).
Set another station to the existing preset number	Start over from step 2. After step 5, press – or + (or TUNING – or + on the unit) repeatedly to select the preset number you want to store the other station.

To change the AM tuning interval (except for European, Russian and Saudi Arabian models and Australian model MHC-RG444S)

The AM tuning interval is factory-preset to 9 kHz (or 10 kHz for some areas). To change the AM tuning interval, tune in any AM station first, then turn off the system. While holding TUNING MODE on the unit, press I/⏻ on the unit. When you change the interval, all the AM preset stations are erased. To reset the interval, repeat the same procedure.

Note

You cannot change the AM tuning interval in Power Saving Mode (page 27).

Tips

- The preset stations are retained for about a day even if you disconnect the power cord or if a power failure occurs.
- To improve broadcast reception, adjust the supplied antennas, or connect a commercially available external antenna.

Listening to the radio

You can listen to a radio station either by selecting a preset station, or by manually tuning in the station.

Listening to a preset station

— Preset Tuning

Preset radio stations in the tuner's memory first (see "Presetting radio stations" on page 15).

- 1 Press TUNER BAND (or FUNCTION repeatedly) to switch the function to tuner.**
- 2 Press TUNER BAND repeatedly to select "FM" or "AM".**
- 3 Press TUNING MODE repeatedly until "PRESET" appears in the display.**
- 4 Press – or + (or TUNING – or + on the unit) repeatedly to select the desired preset station.**

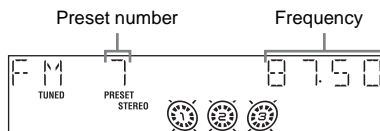

Listening to non-preset radio station

— **Manual Tuning**

- 1** Press **TUNER BAND** (or **FUNCTION** repeatedly) to switch the function to tuner.
- 2** Press **TUNER BAND** repeatedly to select **“FM”** or **“AM”**.
- 3** Press **TUNING MODE** repeatedly until **“AUTO”** and **“PRESET”** disappear from the display.
- 4** Press **– or +** (or **TUNING – or +** on the unit) repeatedly to tune in the desired station.

Tips

- To improve broadcast reception, adjust the supplied antennas, or connect a commercially available external antenna.
- When an FM stereo program has static noise, press **FM MODE** repeatedly until **“MONO”** appears. There will be no stereo effect, but the reception will improve.
- Press **TUNING MODE** repeatedly until **“AUTO”** appears in step 3 above, then press **– or +** (or **TUNING – or +** on the unit). The frequency indication changes and scanning stops when the system tunes in a station (Automatic Tuning).
- To record the radio programs, use manual recording (page 20).

Using the Radio Data System (RDS)

(European model only)

What is the Radio Data System?

Radio Data System (RDS) is a broadcasting service that allows radio stations to send additional information along with the regular program signal. RDS is available only on FM stations.*

Note

RDS may not work properly if the station you are tuned in is not transmitting the RDS signal properly or if the signal is weak.

* Not all FM stations provide RDS service, nor do they provide the same types of services. If you are not familiar with the RDS system, check with your local radio stations for details on RDS services in your area.

Receiving RDS broadcasts

Simply select a station from the FM band.

When you tune in a station that provides RDS services, the station name appears in the display.

To check the RDS information

Each time you press **DISPLAY**, the display changes cyclically as follows:

Station name¹⁾ → Preset number²⁾ and frequency → Clock display → Effect status

¹⁾ If the RDS broadcast is not properly received, the station name may not appear in the display.

²⁾ Preset number is displayed only if you preset radio stations (page 15).

Tape – Play

Loading a tape

Use buttons on the unit for the operation.

- 1 Press TAPE A/B repeatedly to select deck A or B.**
- 2 Press PUSH ▲.**
- 3 Load a recorded/recordable tape in deck A or B with the side you want to play/record facing forward.**

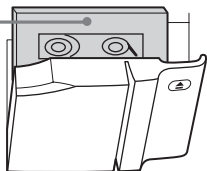

With the side you want to play/record facing forward.





Playing a tape

You can use TYPE I (normal) tape.

For MHC-RG555

- 1 Load a tape.**
- 2 Press PLAY MODE repeatedly to select  to play one side. Select ¹⁾ to play both sides.**

To play both decks in succession, press PLAY MODE repeatedly until “RELAY” (Relay Play)²⁾ appears in the display.

- 3 Press  (or  on the unit).**

The tape starts playing. Press the button again to play the reverse side.

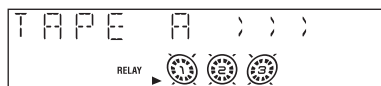

- ¹⁾ The tape deck stops automatically after repeating the sequence five times.
- ²⁾ Relay Play always follows this cyclic sequence up to five times, then stops:
Deck A (front side) → Deck A (reverse side) → Deck B (front side) → Deck B (reverse side)

For other models

- 1 Load a tape.**

To play both decks in succession, press PLAY MODE repeatedly until “RELAY” (Relay Play)* appears in the display.

- 2 Press .**

The tape starts playing.

- * After the playback of the front side of deck A, deck B plays the front side, then stops.

Other operations

To	Do this
Stop play	Press ■.
Pause	Press ■■. Press again to resume play.
Fast-forward or rewind	Press ◀◀ or ▶▶.
Remove a tape	Press PUSH ▲ on the unit.

Searching for the beginning of the current or the next track (AMS)¹⁾

To go forward

Press ▶▶ (or turn ◀◀ ▶▶ on the unit clockwise) during forward playback. “TAPE A (or TAPE B) >>> +1” appears. Press ◀◀ (or turn ◀◀ ▶▶ on the unit counterclockwise) during reverse playback.²⁾ “TAPE A (or TAPE B) <<< +1” appears.

To go back

Press ◀◀ (or turn ◀◀ ▶▶ on the unit counterclockwise) during forward playback. “TAPE A (or TAPE B) <<< -1” appears. Press ▶▶ (or turn ◀◀ ▶▶ on the unit clockwise) during reverse playback.²⁾ “TAPE A (or TAPE B) >>> -1” appears.

¹⁾ AMS (Automatic Music Sensor)

²⁾ MHC-RG555 only

Note

The AMS function may not operate correctly under the following circumstances:

- When the unrecorded space between songs is less than 4 seconds long.
- When the system is placed near a television.

Tip

When a tape is inserted, corresponding forward (▶)/reverse (◀) indicators light. The reverse indicator lights up only for MHC-RG555.

Tape – Recording

Recording your favorite CD tracks on a tape

— CD-TAPE Synchro Recording

You can record a whole CD on a tape. You can use TYPE I (normal) tape. The recording level is adjusted automatically. Use buttons on the unit for the operation.

- 1 Load a recordable tape into deck B, then press TAPE A/B repeatedly to select deck B.**
- 2 (MHC-RG555 only) Press PLAY MODE repeatedly to select ⇐ to record on one side. Select ⇔ (or RELAY) to record on both sides.**

When you want to record from the reverse side, press ◀▶ twice or until the TAPE B reverse side indicator lights up. Then press ■.

- 3 Press CD and load a disc you want to record.**

If you have already loaded the disc, press DISC SKIP/EX-CHANGE to select the disc.

When you want to record an album from an MP3 disc, be sure to press PLAY MODE repeatedly to select ALBM, then press ALBUM – or + to select the desired album before proceeding.

- 4 Press CD SYNC.**

Deck B stands by for recording. “REC” flashes.

- 5 Press REC PAUSE/START.**

Recording starts.

To stop recording

Press ■.

To record a disc by specifying track order

You can record only your favorite CD tracks using Program Play. Between steps 3 and 4, perform steps 2 to 6 of “Creating your own program” (page 14).

Tip

For MHC-RG555, if you select both sides recording and the tape reaches the end of the front side part-way through a track, the entire track is recorded again from the beginning of the reverse side.

Recording on a tape manually

— Manual Recording

You can record just the portions you like from a CD, tape or radio program on a tape.

You can also record from connected components (see “Hooking up optional components” on page 29).

Use buttons on the unit for the operation.

- 1 Load a recordable tape into deck B, then press TAPE A/B repeatedly to select deck B.**
- 2 (MHC-RG555 only)**
Press PLAY MODE repeatedly to select \rightleftarrows to record on one side. Select \leftrightarrow (or RELAY) to record on both sides.
When you want to record from the reverse side, press $\triangleleft \triangleright$ twice or until the TAPE B reverse side indicator lights up. Then press ■.
- 3 Press one of the following buttons to select the desired source to record.**
 - CD: To record from this system’s CD player.
 - TAPE A/B: To record from this system’s tape deck A.
 - TUNER/BAND: To record from this system’s tuner.
 - GAME: To record from the connected video game machine to GAME INPUT AUDIO L/R jacks.
 - VIDEO/MD*: To record from the connected VCR or MD to VIDEO/MD IN jacks.

* MHC-RG555 only
- 4 Press REC PAUSE/START.**
Deck B stands by for recording. “REC” flashes.
- 5 Press REC PAUSE/START, then start playing the desired source to record.**
Recording starts.

To stop recording

Press ■.

Note

You cannot listen to other sources while recording.

Tips

- For MHC-RG555, when you record on both sides, be sure to start from the front side. If you start from the reverse side, recording stops at the end of the reverse side.
- For recording from the tuner:
If noise is heard while recording from the tuner, move the respective antenna to reduce the noise.

Sound Adjustment

Adjusting the sound

You can reinforce the bass and create a more powerful sound.

Press GROOVE on the unit.

Each time you press the button, the display changes cyclically as follows:

GROOVE ON* → GROOVE OFF

* The volume switches to power mode, the equalizer curve changes, and "GROOVE" lights up.

Using the sub woofer

(MHC-GX750/GX450/RG551S/RG444S/RX550 only)

You can use the sound of the sub woofer to suit the sound source.

Press SUB WOOFER ON/OFF on the sub woofer.

The indicator lights up while the sub woofer turns on. Press the button again to turn off the sub woofer.

Tip

You can use VOLUME +/- (or VOLUME control on the unit) to adjust the volume of the sub woofer linked to the front speakers.

Selecting the sound effect

Selecting the effect from the music menu

Press EQ (or PRESET EQ on the unit) repeatedly to select the preset you desire.

The preset name appears in the display. See the chart “Sound effect options”.

To cancel the sound effect

Press EFFECT ON/OFF on the unit.

Sound effect options

“SURR” appears if you select an effect with surround effects.

EQ	Effect
ROCK	Standard music sources
POP	
JAZZ	
DANCE	
SOUL	
ORIENTAL	
MOVIE EQ	Soundtracks and special listening situations
GAME EQ	PlayStation 1, 2 and other video game music sources

Adjusting the graphic equalizer and storing

You can adjust the sound by raising or lowering the levels of specific frequency ranges, then store up to three personal files (P FILE) in the memory.

Before operation, first select the audio emphasis you want for your basic sound.

Use buttons on the unit for the operation.

1 Press EQ BAND repeatedly to select a frequency band, then turn – EQ + to adjust the level.

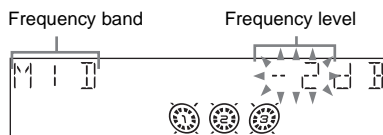

2 Press and hold P FILE.

A personal file number appears.

3 Press P FILE repeatedly to select P FILE 1 – 3 you want to store the equalizer setting.

4 Press ENTER.

“COMPLETE” appears.

This setting is automatically stored as the personal file you selected in step 3.

Other operations

To	Press
Call up a personal file	P FILE repeatedly to select the desired personal file number.
Cancel a personal file	EFFECT ON/OFF repeatedly until “EFFECT OFF” appears.

Selecting the surround effect

Press **SURROUND** on the unit.

Each time you press the button, the display changes as follows:

SURROUND ON (SURR)
↑
SURROUND OFF (off)

Enhancing video game sound

— *Game Sync*

You need to connect a video game machine (see “Hooking up optional components” on page 29).

Press **GAME** on the unit.

Tips

- In the standby mode, the system automatically turns on.
- The GAME EQ is automatically selected (page 22).
- These operations cannot be performed in Power Saving Mode (page 27).

Mixing video game sound with other sound source

— *Game Mixing*

Use buttons on the unit for the operation.

- 1 Select the desired source sound.**
- 2 Press GAME MIXING.**

Each time you press the button, the level of the game sound changes cyclically as follows:

MIXING LOW → MIXING MID →
MIXING HIGH → MIXING OFF

Notes

- If you start recording while Game Mixing is activated, Game Mixing is canceled. To record the mixed sound, press GAME MIXING after step 4 of “Recording on a tape manually” on page 20, and then press REC PAUSE/START to start the recording.
- The game sound is not output while the tape deck is performing the AMS operation (page 19).

Tip

Once Game Mixing is activated, it will remain active while the power is on even if the source sound is changed.

Singing along

(MHC-RG555 only)

You can sing along by connecting an optional microphone.

- 1 Turn MIC LEVEL on the unit to MIN to turn down the microphone control level.**
- 2 Connect an optional microphone to MIC.**
- 3 Start playing the music.**
- 4 Adjust the microphone volume by turning MIC LEVEL on the unit.**

After you have finished

Turn MIC LEVEL on the unit to MIN and disconnect the microphone from MIC.

Mixing and recording sounds

You can “mix” sounds by playing one of the components and singing or speaking into a microphone (not supplied).

The mixed sound can be recorded on a tape. Use buttons on the unit for the operation.

- 1 Prepare the source you want to mix. Then, load a recordable tape in deck B and press TAPE A/B repeatedly to select deck B.**
- 2 Press PLAY MODE repeatedly to select \rightleftarrows to record on one side. Select \leftrightarrow (or RELAY) to record on both sides.**
- 3 Press the function button of the source you want to record (e.g., CD).**

When you want to record from TAPE A, press TAPE A/B repeatedly until TAPE A is selected.
- 4 Press REC PAUSE/START.**

Deck B stands by for recording.
“REC” flashes.
- 5 Press REC PAUSE/START, and then start singing, speaking or playing the desired source.**

Recording starts.

To stop recording

Press ■.

Note

Microphone does not function while the tape deck is performing the AMS operation (page 19).

Tips

- If acoustic feedback (howling) occurs, move the microphone away from the speakers or change the direction of the microphone.
- If you want to record your voice through the microphone only, you can do so by selecting the CD function and not playing a disc.
- When high level sound signals are input, the system automatically adjusts the recording level to prevent distortion of the recorded sound signal (Auto Level Control function).

Falling asleep to music

— Sleep Timer

You can set the system to turn off after a certain time, so that you can fall asleep to music.

Press SLEEP.

Each time you press the button, the minute display (the turn-off time) changes cyclically as follows:

AUTO* → 90MIN → 80MIN → 70MIN
→ ... → 10MIN → OFF

* The system automatically turns off in 100 minutes or after the current disc or tape finishes playing.

Other operations

To	Press
Check the remaining time*	SLEEP once.
Change the time to turn off	SLEEP repeatedly to select the time you want.
Cancel the Sleep Timer Function	SLEEP repeatedly until "SLEEP OFF" appears.

* You cannot check the remaining time if you select "AUTO".

Note

Do not set to "AUTO" during Synchro Recording on a tape.

Tip

You can use the Sleep Timer, even if you have not set the clock.

Waking up to music

— Play Timer

You can wake up to music at a preset time. Make sure you have set the clock (see "Setting the clock" on page 10).

Use buttons on the remote for the operation.

1 Prepare the sound source you want to play.

- CD: Load a disc. To start from a specific track, make a program (see "Creating your own program" on page 14).
- Tape: Load a tape with the side you want to play facing forward.
- Tuner: Tune in the preset radio station (see "Listening to the radio" on page 16).

2 Press VOLUME +/- to adjust the volume.

3 Press CLOCK/TIMER SET.

4 Press ◀◀ or ▶▶ repeatedly to select "PLAY SET", then press ENTER.

"ON" appears and the hour indication flashes.

5 Set the time to start playing.

Press ◀◀ or ▶▶ repeatedly to set the hour, then press ENTER.

The minute indication flashes.

Press ◀◀ or ▶▶ repeatedly to set the minute, then press ENTER.

6 Set the time to stop playing following the same procedure as step 5.

7 Press ◀◀ or ▶▶ repeatedly until the desired sound source appears.

Each time you press the button, the display changes cyclically as follows:



8 Press ENTER.

The type of timer (“PLAY TIMER”), the start time, the stop time, and the sound source appear in turn, before the original display returns.

9 Press I/⏻ to turn off the system.

Other operations

To	Do this
Check the setting	<ol style="list-style-type: none">1 Press CLOCK/TIMER SELECT.2 Press ◀◀ or ▶▶ repeatedly until “PLAY SELECT” appears, then press ENTER.
Change the setting	Start over from step 1.
Cancel the timer	<ol style="list-style-type: none">1 Press CLOCK/TIMER SELECT.2 Press ◀◀ or ▶▶ repeatedly until “TIMER OFF” appears, then press ENTER.

Notes

- You cannot activate the Play Timer and the Rec Timer at the same time.
- If you use the Play Timer and the Sleep Timer at the same time, the Sleep Timer has priority.
- If the system is on at the preset time, the Play Timer will not be activated.

Tip

The system turns on 15 seconds before the preset time.

Timer recording radio programs

— Rec Timer

You can record a preset radio station from a specified time.

To timer record, you must first preset the radio station (see “Presetting radio stations” on page 15) and set the clock (see “Setting the clock” on page 10).

Use buttons on the remote for the operation.

- 1 **Tune in the preset radio station (see “Listening to a preset station” on page 16).**
- 2 **Press CLOCK/TIMER SET.**
- 3 **Press ◀◀ or ▶▶ repeatedly to select “REC SET”, then press ENTER.**
“ON” appears and the hour indication flashes.
- 4 **Set the time to start recording.**
Press ◀◀ or ▶▶ repeatedly to set the hour, then press ENTER.
The minute indication flashes.
Press ◀◀ or ▶▶ repeatedly to set the minute, then press ENTER.
- 5 **Set the time to stop recording following the same procedure as step 4.**
The type of timer (“REC TIMER”), the start time, the stop time, and the preset radio station to be recorded (e.g., “TUNER FM 5”) appear in turn, before the original display returns.
- 6 **Load a recordable tape into deck B.**
- 7 **Press I/⏻ to turn off the system.**

Other operations

To	Do this
Check the setting	<ol style="list-style-type: none">1 Press CLOCK/TIMER SELECT.2 Press ◀◀ or ▶▶ repeatedly until “REC SELECT” appears, then press ENTER.
Change the setting	Start over from step 1.
Cancel the timer	<ol style="list-style-type: none">1 Press CLOCK/TIMER SELECT.2 Press ◀◀ or ▶▶ repeatedly until “TIMER OFF” appears, then press ENTER.

Notes

- You cannot activate the Play Timer and the Rec Timer at the same time.
- If you use the Rec Timer, the Play Timer and the Sleep Timer at the same time, the Sleep Timer has priority.
- If the system is on at the preset time, the Rec Timer will not be activated.
- The volume is reduced to minimum during recording.

Display

Turning off the display

— Power Saving Mode

The demonstration display (display window and buttons lighting and flashing even when the system power is off) and the clock display can be turned off to minimize the amount of power consumed during standby (Power Saving Mode).

Press DISPLAY repeatedly while the system is off until the demonstration display or the clock display disappears.

To cancel Power Saving Mode

Press DISPLAY while the system is off. Each time you press the button, the display switches cyclically as follows:

Demonstration display → Clock display* → No display (Power Saving Mode)

* The clock is displayed only if you set the clock.

Note

You cannot perform the following operations in Power Saving Mode.

- setting the clock
- changing the AM tuning interval (except for European, Russian and Saudi Arabian models and Australian model MHC-RG444S)
- turning on the system by pressing the function buttons (e.g., CD)

Tips

- The timer continues to operate in Power Saving Mode.
- I/Ⓢ indicator lights up even in Power Saving Mode.

Viewing information about the disc in the display

You can check the playing time and remaining time of the current track or that of the disc.

Checking the remaining time and titles (CD/MP3)

Press **DISPLAY** during Normal Play.

Each time you press the button, the display changes cyclically as follows:

Current track number and elapsed playing time
→ Current track number and remaining time¹⁾
→ Remaining time of the disc²⁾ → Track title (disc with MP3 audio tracks³⁾ only → Album name (disc with MP3 audio tracks only) → Clock display (for eight seconds) → Effect status

- 1) “- - - -” appears when playing back MP3 audio tracks.
- 2) “- - - -” appears in ALL DISCS, SHUFFLE or program play mode or when playing back MP3 audio tracks.
- 3) When you play back a track with an ID3 tag ver. 1 or ver. 2, the ID3 tag appears. The ID3 tag displays only the track title information.

Checking the total playing time and titles (CD/MP3)

Press **DISPLAY** in stop mode.

Each time you press the button, the display changes cyclically as follows:

■ When a CD/MP3 is in Normal Play mode

TOC display¹⁾ or total album number of the disc²⁾ or total track number of the current album²⁾ → Album name²⁾ or volume label²⁾ → Clock display (for eight seconds) → Effect status

- 1) TOC = Table of Contents; displays current disc number, total number of tracks on the disc, and total playing time of the disc.
- 2) For discs with MP3 audio tracks, album names or volume label may not be displayed depending on the play mode.

■ When a CD/MP3 is in Program Play mode

The last track number of the program and the total playing time → Total track number of the program (for five seconds) → Volume label* → Clock display (for eight seconds) → Effect status

* For discs with MP3 audio tracks

Checking the station name (TUNER)

Press **DISPLAY** while listening to the radio.

Each time you press the button, the display changes cyclically as follows:

Station name¹⁾ → Preset number²⁾ and frequency → Clock display (for eight seconds) → Effect status

1) European model only

2) Preset number is displayed only if you preset radio stations (page 15).

Notes

- The total playing time is not displayed for a disc with MP3 audio tracks.
- ID3 tag applies to version 1 and version 2.
- If the MP3 audio track you play back has an ID3 tag, the ID3 tag information is displayed as a track title.
- In the following cases, elapsed playing time and remaining time of the track may not be displayed accurately.
 - when an MP3 audio track of VBR (variable bit rate) is played.
 - when fast forward or fast reverse is performed.
- For Russian model, MP3 and ID3 tag information can be displayed in Russian characters. However, depending on the encoding/writing software or recording device, the characters may not be correctly displayed.

Changing the Power illuminator

(MHC-GX750/GX450/RG555/RG551S/RG444S/RG441/RG333/RX550 only)

Press **ILLUMINATION** on the unit.

Each time you press the button, the power illuminator changes cyclically as follows:

PATTERN 1 → PATTERN 2 → PATTERN 3 → PATTERN OFF

Optional Components

Hooking up optional components

To enhance your system, you can connect optional components. Refer to the operating instructions provided with each component. A model equipped with a sub woofer is used for illustration purpose.

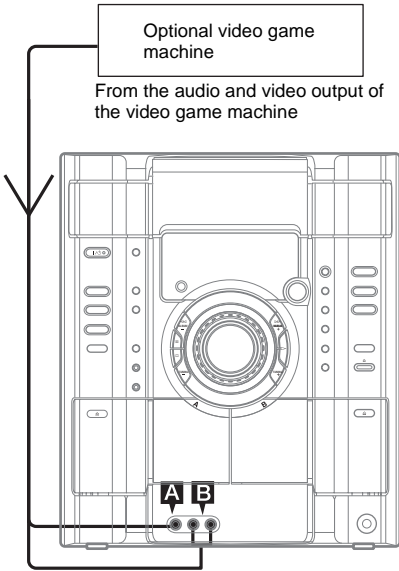

A GAME INPUT VIDEO jack

Use a video cable (not supplied) to connect the video output of the optional video game machine to this jack.

B GAME INPUT AUDIO L/R jacks

Use audio cords (not supplied) to connect the audio output of the optional video game machine to these jacks. You can then output audio through this system.

C VIDEO OUT jack

Use a video cable (not supplied) to connect the video input of TV to this jack.

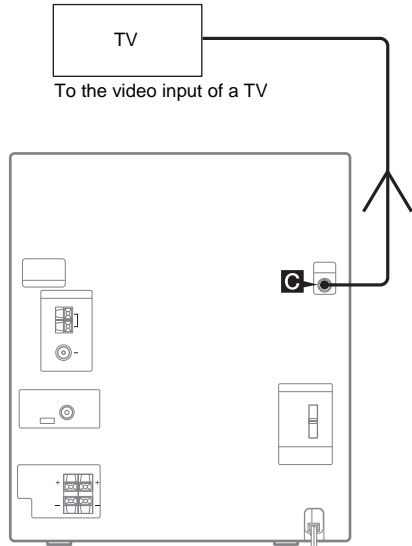

D VIDEO/MD IN jacks (MHC-RG555 only)

Use audio cords (not supplied) to connect the audio output of the optional component (such as VCR or MD deck) to these jacks. You can then output audio through this system.

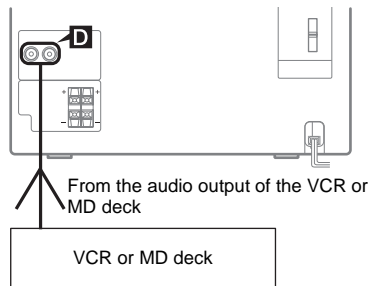

Notes

- The video game machine image may appear on the TV screen even if the system is turned off.
- See “Selecting the surround effect” on page 23 for video game sound effects.
- If you press GAME on the unit while the system is off, the system turns on, the function switches to GAME, and the equalizer also switches to GAME EQ.
- If you press GAME on the unit while the system is on, the function switches to GAME and the equalizer automatically switches to GAME EQ in the same manner.

Listening to audio from a connected component (MHC-RG555 only)

Use buttons on the unit for the operation.

Listening to a connected VCR

- 1 Connect the audio cords.
See “Hooking up optional components” on page 29.
- 2 Press VIDEO/MD.
Start playing the connected component.

Listening to a connected MD deck

- 1 Connect the audio cords.
See “Hooking up optional components” on page 29.
- 2 Press VIDEO/MD.
Hold down VIDEO/MD and press I/⏸. This switches the VIDEO function to MD. Once you enable the MD function, just press VIDEO/MD.

Notes

- If you cannot select “MD” when you press VIDEO/MD, press I/⏸ while holding down VIDEO/MD when the system is on. “VIDEO” will be switched to “MD”. To return to “VIDEO”, do the same procedure.
- When you connect a VIDEO CD deck, set to “MD”.

Transmitter

(MHC-GX750 only)

Hooking up the transmitter

1 Set the transmitter by the following procedures.

Select either AUDIO IN A or AUDIO IN B hookup depending on the jack type of the optional component you want to connect the transmitter to. If noise occurs when the transmitter is connected to the headphones jack of your TV or VCR, set the NOISE FILTER switch on the transmitter to ON.

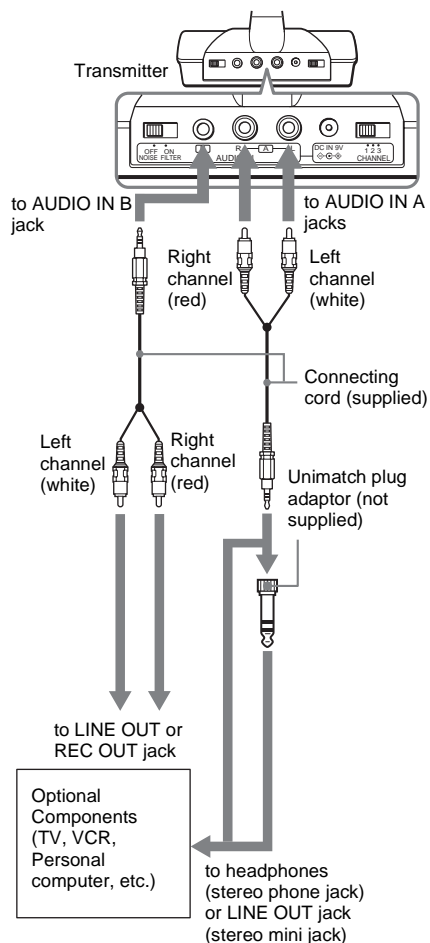

2 Connect the transmitter to a wall outlet using the supplied AC power adaptor.

The transmitter automatically turns on.

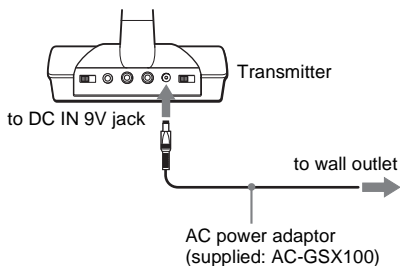

Notes

- When you connect the transmitter to the analog out jacks, do not set the NOISE FILTER to ON. Otherwise, the volume will be limited.
- The NOISE FILTER effects the sound only when you connect an optional component to the AUDIO IN A jacks of the transmitter. Connecting to the AUDIO IN B jack, the switch has no effect.
- If stereo mini jack is connected to LINE OUT and the NOISE FILTER is set to ON, audio output will be reduced and audio signal may be intermittent or auto muting will activate. In this case, set the NOISE FILTER to OFF.
- When the transmitter is placed on or near a TV, it may pick up a noise. In such case, place the transmitter away from the TV.
- Do not place the transmitter near a fluorescent lamp, etc. when using the system.
- Use only the supplied AC power adaptor. Do not use any other AC power adaptor.



Polarity of the plug

- If the connected component has the AVLS (Automatic Volume Limiter System) function, be sure to turn off the function when using the transmitter. Otherwise, you will have to turn up the volume of the speaker, and that may cause distortion.
- If the connected component has the BASS BOOST or MEGA BASS function, be sure to turn off the function when using the transmitter. Otherwise, the sound from the speaker may be distorted.

The effective areas of the transmitter

Wireless system that allows you to use your system free from the restriction of speaker cords. The optimum signal reception range is up to approximately 30.5 m (100 feet) without the system picking up some interference. However, the distance may be reduced according to the surroundings and environment. If the system picks up some noise while using it within the above mentioned distance, reduce the distance between the transmitter unit and the main unit, or select another channel.

Notes

- When you use the main unit inside the effective areas of the transmitter, the transmitter can be placed in any direction from the listener.
- Even within the signal reception area, there are some spots (dead spot) where the RF signal cannot be received. This is a characteristic inherent to RF signals, and does not indicate a malfunction. By slightly moving the transmitter, the location of the dead spot can be changed.

Notes on receiving performance

This system component utilizes very high frequency signals in the 900 MHz band so the receiving performance may deteriorate due to the surroundings. The following examples illustrate conditions that may reduce the possible receiving range or cause interference with reception.

- Radio waves generated such as cellphones and cordless phone systems or metal instruments are placed on the unit.
- Inside a building with walls containing steel beams.
- Area with many steel file cabinets, etc.
- Area with many electrical appliances capable of generating electromagnetic noise.
- Transmitter is placed on a metal instrument.
- Area facing roadways.
- Noise or interfering signals exist in the surroundings due to radio transceivers in trucks, etc.
- Noise or interfering signals exist in the surroundings due to wireless communication systems installed along roadways.
- Transmitter is placed directly on floor. Placing it up off the floor, such as on a desk, is recommended.

Listening to audio using wireless system

- 1 Start playing the connected component.**
- 2 Press WIRELESS on the unit to switch the function to WIRELESS.**

When the sound is distorted

- 1 Move CHANNEL 1–3 on the transmitter to select a radio frequency.

CHANNEL 1: 913.6 MHz

CHANNEL 2: 914.0 MHz

CHANNEL 3: 914.4 MHz

- 2 Press WIRELESS on the unit.
“AUTO SCAN” appears.

When FM broadcast or noise or no audio is heard, press WIRELESS on the unit several times. If you do not hear clear audio, select another channel using CHANNEL 1–3 on the transmitter, then press WIRELESS on the unit again.

To finish using WIRELESS function

Press any function button to select different function and quit WIRELESS.

Notes

- You may not hear the beginning of the sound from the main unit until the transmitter starts sending the RF signals after detecting an audio signal.
- If the transmitter is connected to the headphones jack of the source component, set the volume of that component as high as possible without distorting the audio signal.
- If you hold the antenna of the transmitter with your hand, noise may occur. However this is not a malfunction.
- When the transmitter is not to be used for a long period of time, disconnect the AC power adaptor from the wall outlet holding the plug. Do not pull on the cord.

Problems and remedies

Should you encounter a problem with your system, do the following:

- 1 Make sure the power cord and speaker cords are correctly and firmly connected.
- 2 Find your problem in the troubleshooting checklist below and take the indicated corrective action.

If the problem persists after doing all of the above, consult your nearest Sony dealer.

When the I/⏻ indicator flashes

Immediately unplug the power cord and check the following items.

- If your system has a voltage selector, is the voltage selector set to the correct voltage? Check the voltage for your region, then make sure the voltage selector is set correctly.
- Are the + and – speaker cords short-circuited?
- Are you using only the prescribed speakers?
- Is anything blocking the ventilation holes on the rear of the system?

Check all the above items and fix any problems found. After I/⏻ indicator stops flashing, reconnect the power cord and turn on the system. If the indicator still flashes, or if the cause of the problem cannot be found even after checking all the above items, consult your nearest Sony dealer.

General

The display starts flashing as soon as you plug in the power cord even though you have not turned on the system (see step 5 of “Hooking up the system” (page 7)).

- Press DISPLAY twice while the system is off. The demonstration disappears.

“- -: -” appears in the display.

- A power interruption has occurred. Set the clock (page 10) and timer settings (pages 25 and 26) again.

The clock setting/radio presetting/timer is canceled.

- Redo the following:
 - “Setting the clock” (page 10)
 - “Presetting radio stations” (page 15)
 - “Falling asleep to music” and “Waking up to music” (page 25)
 - “Timer recording radio programs” (page 26)

There is no sound.

- Press VOLUME +/- or turn VOLUME control on the unit clockwise.
- Make sure the headphones are not connected.
- Check the speaker connections (page 7).
- There is no audio output during the Rec Timer.

Sound comes from one channel, or unbalanced left and right volume.

- Place the speakers as symmetrically as possible.
- Connect the supplied speakers.

Sound lacks bass.

- Check that the speaker’s + and – jacks are connected correctly.

There is severe hum or noise.

- Move the system away from the source of noise.
- Connect the system to a different wall outlet.
- Install a noise filter (commercially available) to the power cord.

The timer cannot be set.

- Set the clock again (page 10).

The timer does not function.

- Check the timer setting and set the correct time (pages 26 and 27).
- Cancel the Sleep Timer Function (page 25).

The remote does not function.

- Remove the obstacle.
- Move the remote closer to the system.
- Point the remote at the system's sensor.
- Replace the batteries (R6/size AA).
- Locate the system away from the fluorescent light.

There is acoustic feedback.

- Reduce the volume.
- For MHC-RG555, move the microphone away from the speakers or change the direction of the microphone.

The color irregularity on a TV screen persists.

- Turn off the TV set once, then turn it on after 15 to 30 minutes. If the color irregularity still persists, place the speakers farther away from the TV set.

The sound from the connected source is distorted (MHC-RG555 only).

- If "VIDEO" appears in the display when you press VIDEO/MD on the unit, switch the display to "MD" (see "Listening to audio from a connected component (MHC-RG555 only)" on page 30).

CD/MP3 player

The disc tray does not open and "LOCKED" appears.

- Contact your Sony dealer or local authorized Sony service facility.

The disc tray does not close.

- Place the disc correctly.
- Always close the tray by pressing ▲ on the unit. Trying to press the tray closed with your fingers may cause problems with the player.

The disc does not eject.

- You cannot eject the disc during CD Synchro Recording. Press ■ to cancel the CD Synchro Recording, then press ▲ on the unit to eject the disc.
- Consult your nearest Sony dealer.

Play does not start.

- Open the disc tray and check whether a disc is loaded.
- Wipe the disc clean (page 37).
- Replace the disc.
- Place the disc that this system can play (page 5).
- Place the disc correctly.
- Place the disc in the tray with the label side up.
- Remove the disc and wipe away the moisture on the disc, then leave the system turned on for a few hours until the moisture evaporates.
- Press ► to start play.

The sound skips.

- Wipe the disc clean (page 37).
- Replace the disc.
- Try moving the system to a place without vibration (e.g., on top of a stable stand).
- Try moving the speakers away from the system, or placing them on separate stands. When you listen to a track with bass sounds at high volume, the speaker vibration may cause the sound to skip.

Play does not start from the first track.

- Press PLAY MODE repeatedly until both "PGM" and "SHUF" disappear to return to Normal Play.

MP3 audio track cannot be played back.*

- Recording was not performed according to the ISO9660 level 1 or level 2 format or Joliet in the expansion format.
- The MP3 audio track does not have the extension ".MP3".
- The data is not stored in MP3 format.
- Discs containing files other than MPEG 1 Audio Layer-3 files cannot be played.

MP3 audio tracks take longer to play back than others.*

- After the system reads all tracks on the discs, playback may take more time than usual if:
 - the number of albums or tracks on the disc is very large.
 - the album and track organization structure is very complex.

The album name, track title and ID3 tag do not appear correctly.*

- Use a disc that conforms with ISO9660 level 1, level 2 or Joliet in the expansion format.
- The disc ID3 tag is not ver. 1 nor ver. 2.

* MHC-GX750/GX450/RG555/RG551S/RG444S/RG441/RG333/RG222/RG221/RX550 only

Tuner

Severe hum or noise/stations cannot be received. (“TUNED” or “STEREO” flashes in the display.)

- Set the proper band and frequency (page 15).
- Connect the antenna properly (page 8).
- Find a place and an orientation that provide good reception, then set up the antenna again. If you cannot obtain good reception, we recommend you connect a commercially available external antenna.
- The supplied FM lead antenna receives signals along its entire length, so make sure you extend it fully.
- Locate the antennas as far away from the speaker cords as possible.
- Try turning off surrounding electrical equipment.

A stereo FM program cannot be received in stereo.

- Press FM MODE repeatedly until “STEREO” appears.

Tape deck

The tape does not record or play, or there is a decrease in sound level.

- The heads are dirty. Clean them (page 38).
- The record/playback heads are magnetized. Demagnetize them (page 38).

The tape does not erase completely.

- The record/playback heads are magnetized. Demagnetize them (page 38).

There is excessive wow or flutter, or the sound drops out.

- The capstans or pinch rollers are dirty. Clean them (page 38).

Noise increases or the high frequencies are erased.

- The record/playback heads are magnetized. Demagnetize them (page 38).

The tape does not record.

- No cassette is loaded. Load a cassette.
 - The tab has been removed from the cassette. Cover the broken tab with adhesive tape (page 38).
 - The tape has wound to the end.
-

Transmitter (MHC-GX750 only)

There is no sound.

- Check the connection of the optional component.
- Check that the optional component is turned on.
- Turn up the volume on the connected optional component, if the transmitter is connected to the headphones jack.
- Change the radio frequency using the CHANNEL selector on the transmitter, then press WIRELESS on the unit again.
- If you connect the transmitter to the analog out jacks of an audio reproducer, make sure that the NOISE FILTER switch is set to OFF.
- Make sure that the NOISE FILTER switch is set to either ON or OFF (If the switch gets stuck between ON and OFF, the sound will be cut off).

There is severe hum or noise.

- If the transmitter is connected to the headphones jack, turn down the volume of the connected optional component. If the connected optional component has the BASS BOOST or MEGA BASS function, set these function to OFF.
- If the connected optional component has a LINE OUT jacks, connect its LINE OUT jacks.
- Change the radio frequency with the CHANNEL selector on the transmitter then press WIRELESS on the unit again.
- If you connect the transmitter to the analog out jacks of an audio reproducer, make sure that the NOISE FILTER switch is set to OFF.

If the system still does not operate properly after performing the above measures, reset the system as follows:

Use buttons on the unit for the operation.

- 1 Disconnect the power cord.
- 2 Reconnect the power cord.
- 3 Press **■**, PLAY MODE/TUNING MODE and DISC 1 at the same time.
- 4 Press I/⏻ to turn on the system.

The system is reset to the factory settings. You should set the settings you made, such as the preset stations, clock, and timer.

Messages

One of the following messages may appear or flash in the display during operation.

CD/MP3

NO DISC

There is no disc in the player or you have loaded a disc that cannot be played on this system (such as DVD, VCD, or CD-ROM without MP3 audio tracks, etc.).

OVER

You have reached the end of the disc while pressing **▶▶** during playback or pause.

PUSH STOP

You pressed **PLAY MODE** during playback.

READING

The system is reading information of the disc. Some buttons are not available.

STEP FULL

You tried to program 26 or more tracks (steps).

Tape

NO TAB

You cannot record the tape because the tab has been removed from the cassette.

NO TAPE

There is no tape in the tape deck.

Additional Information

Precautions

On operating voltage

Before operating the system, check that the operating voltage of your system is identical with the voltage of your local power supply.

On safety

- The unit is not disconnected from the AC power source (mains) as long as it is connected to the wall outlet, even if the unit itself has been turned off.
- Unplug the system from the wall outlet (mains) if it is not to be used for an extended period of time. To disconnect the power cord (mains lead), pull it out by the plug. Never pull the cord itself.
- Should any solid object or liquid fall into the system, unplug the system and have it checked by qualified personnel before operating it any further.
- AC power cord must be changed only at the qualified service shop.

On placement

- Do not place the system in an inclined position.
- Do not place the system in locations where it is;
 - Extremely hot or cold
 - Dusty or dirty
 - Very humid
 - Subject to vibrations
 - Subject to direct sunlight.
- Use caution when placing the unit or speakers on surfaces that have been specially treated (with wax, oil, polish, etc.) as staining or discoloration of the surface may result.

On heat buildup

- Although the system heats up during operation, this is not a malfunction.
- Place the system in a location with adequate ventilation to prevent heat buildup in the system.
- If you continuously use this system at a high volume, the cabinet temperature of the top, side and bottom rises considerably. To avoid burning yourself, do not touch the cabinet.
- To prevent a malfunction, do not cover the ventilation hole for the cooling fan.

On the speaker system

This speaker system is not magnetically shielded and the picture on TV sets may become magnetically distorted. In such a case, turn off the power of the TV set once, and after 15 to 30 minutes turn it on again.

If there seems to be no improvement, locate the speaker system further away from the TV set.

On operation

- If the system is brought directly from a cold to a warm location, or is placed in a very damp room, moisture may condense on the lens inside the CD player. Should this occur, the system will not operate properly. Remove the disc and leave the system turned on for about an hour until the moisture evaporates.
- When you move the system, take out any disc.

If you have any questions or problems concerning your system, please consult your nearest Sony dealer.

Notes on discs

- Before playing, clean the disc with a cleaning cloth. Wipe the disc from the center out.
- Do not use solvents such as benzine, thinner, commercially available cleaners or anti-static spray intended for vinyl LPs.
- Do not expose the disc to direct sunlight or heat sources such as hot air ducts, nor leave it in a car parked in direct sunlight.
- When using discs that have glue or similar tacky substance on the label side of the disc or that used a special ink when the label was printed, there is a chance that the disc or label may become attached to parts inside this unit. When this occurs, it may not be possible to remove the disc, and may also cause this unit to malfunction. Be sure to check that the label side of the disc is not sticky before using.
The following types of disc should not be used:
 - Rental or used discs with attached seals where the glue extends beyond the seal. The perimeter of the seal on the disc is tacky.
 - Discs that have labels printed using a special ink that feels tacky when touched.
- Discs with non-standard shapes (e.g., heart, square, star) cannot be played on this unit. Attempting to do so may damage the unit. Do not use such discs.

Cleaning the cabinet

Clean the cabinet, panel and controls with a soft cloth slightly moistened with mild detergent solution. Do not use any type of abrasive pad, scouring powder or solvent such as thinner, benzine or alcohol.

To save a tape permanently

To prevent a tape from being accidentally recorded over, break off the cassette tab from side A or B as illustrated.

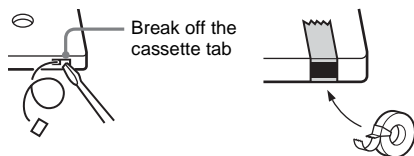

If you later want to reuse the tape for recording, cover the broken tab with adhesive tape.

Before placing a cassette in the tape deck

Take up any slack in the tape. Otherwise, the tape may get entangled in the parts of the tape deck and become damaged.

When using a tape longer than 90 minutes

The tape is very elastic. Do not change the tape operations such as play, stop, and fast-winding frequently. The tape may get entangled in the tape deck.

Cleaning the tape heads

Clean the tape heads after every 10 hours of use. Be sure to clean the tape heads before you start an important recording or after playing an old tape. Use a separately sold dry-type or wet-type cleaning cassette. For details, refer to the instructions of the cleaning cassette.

Demagnetizing the tape heads

Demagnetize the tape heads and the metal parts that have contact with the tape after every 20 to 30 hours of use with a separately sold demagnetizing cassette. For details, refer to the instructions of the demagnetizing cassette.

Specifications

Main unit

Amplifier section

AUDIO POWER SPECIFICATIONS (MHC-GX750/GX450/GX250/RX550 USA models only)

MHC-GX750/RX550

POWER OUTPUT AND TOTAL HARMONIC DISTORTION:

With 6 ohm loads, both channels driven, from 120 – 10,000 Hz: rated 160 watts per channel minimum RMS power, with no more than 10% total harmonic distortion from 250 milliwatts to rated output.

MHC-GX450

POWER OUTPUT AND TOTAL HARMONIC DISTORTION:

With 6 ohm loads, both channels driven, from 120 – 10,000 Hz: rated 125 watts per channel minimum RMS power, with no more than 10% total harmonic distortion from 250 milliwatts to rated output.

MHC-GX250

POWER OUTPUT AND TOTAL HARMONIC DISTORTION:

With 6 ohm loads, both channels driven, from 120 – 10,000 Hz: rated 140 watts per channel minimum RMS power, with no more than 10% total harmonic distortion from 250 milliwatts to rated output.

North American models:

MHC-GX750/RX550

Front speaker

Continuous RMS power output (reference):

160 + 160 watts (6 ohms at 1 kHz, 10% THD)

Total harmonic distortion less than 0.07% (6 ohms at 1 kHz, 80 W)

Sub woofer

Continuous RMS power output (reference):

180 watts (6 ohms at 50 Hz, 10% THD)

Total harmonic distortion less than 0.07% (6 ohms at 50 Hz, 90 W)

MHC-GX450

Front speaker

Continuous RMS power output (reference):

125 + 125 watts (6 ohms at
1 kHz, 10% THD)

Total harmonic distortion less than 0.07% (6 ohms at
1 kHz, 60 W)

Sub woofer

Continuous RMS power output (reference):

150 watts (6 ohms at
50 Hz, 10% THD)

Total harmonic distortion less than 0.07% (6 ohms at
50 Hz, 75 W)

MHC-GX250

Continuous RMS power output (reference):

140 + 140 watts (6 ohms at
1 kHz, 10% THD)

Total harmonic distortion less than 0.07% (6 ohms at
1 kHz, 70 W)

European and Russian models:

MHC-RG444S

Front speaker

DIN power output (rated): 100 + 100 watts (6 ohms at
1 kHz, DIN)

Continuous RMS power output (reference):

120 + 120 watts (6 ohms at
1 kHz, 10% THD)

Music power output (reference):

240 + 240 watts (6 ohms at
1 kHz, 10% THD)

Sub woofer

DIN power output (rated): 100 watts (6 ohms at
60 Hz, DIN)

Continuous RMS power output (reference):

120 watts (6 ohms at
50 Hz, 10% THD)

Music power output (reference):

240 watts (6 ohms at
50 Hz, 10% THD)

MHC-RG333

DIN power output (rated): 100 + 100 watts (6 ohms at
1 kHz, DIN)

Continuous RMS power output (reference):

125 + 125 watts (6 ohms at
1 kHz, 10% THD)

Music power output (reference):

250 + 250 watts (6 ohms at
1 kHz, 10% THD)

MHC-RG222/RG121

DIN power output (rated): 50 + 50 watts (6 ohms at
1 kHz, DIN)

Continuous RMS power output (reference):

65 + 65 watts (6 ohms at
1 kHz, 10% THD)

Music power output (reference):

130 + 130 watts (6 ohms at
1 kHz, 10% THD)

MHC-RG100

DIN power output (rated): 15 + 15 watts (6 ohms at
1 kHz, DIN)

Continuous RMS power output (reference):

20 + 20 watts (6 ohms at
1 kHz, 10% THD)

Music power output (reference):

40 + 40 watts (6 ohms at
1 kHz, 10% THD)

Other models:

MHC-RG555

The following measured at AC 120, 127, 220, 240 V
50/60 Hz

DIN power output (rated): 120 + 120 watts (6 ohms at
1 kHz, DIN)

Continuous RMS power output (reference):

150 + 150 watts (6 ohms at
1 kHz, 10% THD)

MHC-RG551S/RG444S

The following measured at AC 120, 127, 220, 240 V
50/60 Hz

Front speaker

DIN power output (rated): 100 + 100 watts (6 ohms at
1 kHz, DIN)

Continuous RMS power output (reference):

120 + 120 watts (6 ohms at
1 kHz, 10% THD)

Sub woofer

DIN power output (rated): 100 watts (6 ohms at
50 Hz, DIN)

Continuous RMS power output (reference):

120 watts (6 ohms at
50 Hz, 10% THD)

MHC-RG441

The following measured at AC 120, 127, 220, 240 V
50/60 Hz

DIN power output (rated): 120 + 120 watts (6 ohms at
1 kHz, DIN)

Continuous RMS power output (reference):

150 + 150 watts (6 ohms at
1 kHz, 10% THD)

MHC-RG222/RG221

The following measured at AC 120, 127, 220, 240 V
50/60 Hz

DIN power output (rated): 100 + 100 watts (6 ohms at
1 kHz, DIN)

Continuous RMS power output (reference):
120 + 120 watts (6 ohms at
1 kHz, 10% THD)

MHC-RG121

The following measured at AC 120, 127, 220, 240 V
50/60 Hz

DIN power output (rated): 50 + 50 watts (6 ohms at
1 kHz, DIN)

Continuous RMS power output (reference):
60 + 60 watts (6 ohms at
1 kHz, 10% THD)

Inputs

VIDEO/MD IN (phono jacks) (MHC-RG555 only):
voltage 450/250 mV,
impedance 47 kilohms

GAME INPUT AUDIO L/R (phono jacks):
voltage 250 mV,
impedance 47 kilohms

GAME INPUT VIDEO (phono jack):
1Vp-p, 75 ohms

MIC (phone jack) (MHC-RG555 only):
sensitivity 1 mV,
impedance 10 kilohms

Outputs

PHONES (stereo mini jack):
accepts headphones of
8 ohms or more

VIDEO OUT (phono jack):
max. output level 1Vp-p,
unbalanced, Sync
negative, load impedance
75 ohms

SPEAKER:
accepts impedance of 6 to
16 ohms

SUB WOOFER OUT (MHC-GX750/GX450/
RG551S/RG444S/RX550 only):
accepts impedance of 6 to
16 ohms

CD player section

System Compact disc and digital
audio system

Laser Semiconductor laser
($\lambda=770-810$ nm)
Emission duration:
continuous

Frequency response 2 Hz – 20 kHz (± 0.5 dB)

Signal-to-noise ratio More than 90 dB

Dynamic range More than 90 dB

Tape deck section

Recording system 4-track 2-channel, stereo
Frequency response 50 – 13,000 Hz (± 3 dB),
using Sony TYPE I
cassettes

Wow and flutter $\pm 0.15\%$ W. Peak (IEC)
0.1% W. RMS (NAB)
 $\pm 0.2\%$ W. Peak (DIN)

Tuner section

FM stereo, FM/AM superheterodyne tuner

FM tuner section

Tuning range

North American model: 87.5 – 108.0 MHz
(100-kHz step)

Russian model: 65.0 – 74.0 MHz
(There is no stereo effect.
10-kHz step)
87.5 – 108.0 MHz
(50-kHz step)

Other models: 87.5 – 108.0 MHz
(50-kHz step)

Antenna FM lead antenna
Antenna terminals 75 ohms unbalanced
Intermediate frequency 10.7 MHz

AM tuner section

Tuning range

Pan-American models: 530 – 1,710 kHz
(with the tuning interval
set at 10 kHz)
531 – 1,710 kHz
(with the tuning interval
set at 9 kHz)

European, Russian and Saudi Arabian models and
Australian model MHC-RG444S:
531 – 1,602 kHz (with the
tuning interval set at
9 kHz)

Other models: 530 – 1,710 kHz
(with the tuning interval
set at 10 kHz)
531 – 1,602 kHz
(with the tuning interval
set at 9 kHz)

Antenna AM loop antenna
Antenna terminals External antenna terminal
Intermediate frequency 450 kHz

Speaker

North American models:

Front speaker SS-RG555 for MHC-GX750/RX550

Speaker system	3-way, 3-unit, bass-reflex type
Speaker units	
Woofer:	15 cm, cone type
Sub woofer:	15 cm, cone type
Tweeter:	5 cm, cone type
Nominal impedance	6 ohms
Dimensions (w/h/d)	Approx. 267 × 365 × 295 mm
Mass	Approx. 5.1 kg net per speaker

Sub woofer SS-WG750 for MHC-GX750/RX550

Speaker system	Bass-reflex type
Speaker units	
Woofer:	20 cm, cone type
Nominal impedance	6 ohms
Dimensions (w/h/d)	Approx. 267 × 327 × 365 mm
Mass	Approx. 7.5 kg

Front speaker SS-RG444 for MHC-GX450/GX250

Speaker system	3-way, 3-unit, bass-reflex type
Speaker units	
Woofer:	13 cm, cone type
Sub woofer:	13 cm, cone type
Tweeter:	5 cm, cone type
Nominal impedance	6 ohms
Dimensions (w/h/d)	Approx. 242 × 327 × 235 mm
Mass	Approx. 3.7 kg net per speaker

Sub woofer SS-WG450 for MHC-GX450

Speaker system	Bass-reflex type
Speaker units	
Woofer:	20 cm, cone type
Nominal impedance	6 ohms
Dimensions (w/h/d)	Approx. 267 × 327 × 365 mm
Mass	Approx. 5.7 kg

European and Russian models: Front speaker SS-RG444 for MHC-RG444S/RG222

Speaker system	3-way, 3-unit, bass-reflex type
Speaker units	
Woofer:	13 cm, cone type
Sub woofer:	13 cm, cone type
Tweeter:	5 cm, cone type
Nominal impedance	6 ohms
Dimensions (w/h/d)	Approx. 242 × 327 × 235 mm
Mass	Approx. 3.7 kg net per speaker

Sub woofer SS-WG450 for MHC-RG444S

Speaker system	Bass-reflex type
Speaker units	
Woofer:	20 cm, cone type
Nominal impedance	6 ohms
Dimensions (w/h/d)	Approx. 267 × 327 × 365 mm
Mass	Approx. 5.7 kg

Front speaker SS-RG555 for MHC-RG333

Speaker system	3-way, 3-unit, bass-reflex type
Speaker units	
Sub Woofer:	15 cm, cone type
Woofer:	15 cm, cone type
Tweeter:	5 cm, cone type
Nominal impedance	6 ohms
Dimensions (w/h/d)	Approx. 267 × 365 × 295 mm
Mass	Approx. 5.1 kg net per speaker

Front speaker SS-RG121 for MHC-RG121/RG100

Speaker system	3-way, 3-unit, bass-reflex type
Speaker units	
Super Tweeter:	2 cm, dome type
Woofer:	13 cm, cone type
Tweeter:	5 cm, cone type
Nominal impedance	6 ohms
Dimensions (w/h/d)	Approx. 202 × 327 × 230 mm
Mass	Approx. 3.0 kg net per speaker

Other models:

Front speaker SS-RG555 for MHC-RG555/ RG551S/RG441

Speaker system	3-way, 3-unit, bass-reflex type
Speaker units	
Sub Woofer:	15 cm, cone type
Woofer:	15 cm, cone type
Tweeter:	5 cm, cone type
Nominal impedance	6 ohms
Dimensions (w/h/d)	Approx. 267 × 365 × 295 mm
Mass	Approx. 5.1 kg net per speaker

Sub woofer SS-WG750 for MHC-RG551S

Speaker system	Bass-reflex type
Speaker units	
Woofer:	20 cm, cone type
Nominal impedance	6 ohms
Dimensions (w/h/d)	Approx. 267 × 327 × 365 mm
Mass	Approx. 7.5 kg

Front speaker SS-RG444 for MHC-RG444S/ RG222/RG221

Speaker system	3-way, 3-unit, bass-reflex type
Speaker units	
Sub woofer:	13 cm, cone type
Woofer:	13 cm, cone type
Tweeter:	5 cm, cone type
Nominal impedance	6 ohms
Dimensions (w/h/d)	Approx. 242 × 327 × 235 mm
Mass	Approx. 3.7 kg net per speaker

Sub woofer SS-WG450 for MHC-RG444S

Speaker system	Bass-reflex type
Speaker units	
Woofer:	20 cm, cone type
Nominal impedance	6 ohms
Dimensions (w/h/d)	Approx. 267 × 327 × 365 mm
Mass	Approx. 5.7 kg

Front speaker SS-RG121 for MHC-RG121

Speaker system	3-way, 3-unit, bass-reflex type
Speaker units	
Super Tweeter:	2 cm, dome type
Woofer:	13 cm, cone type
Tweeter:	5 cm, cone type
Nominal impedance	6 ohms
Dimensions (w/h/d)	Approx. 202 × 327 × 230 mm
Mass	Approx. 3.0 kg net per speaker

Transmitter

TMR-HT1 for MHC-GX750

Carrier frequency	913.6 – 914.4 MHz
Channel	
CHANNEL 1:	913.6 MHz
CHANNEL 2:	914.0 MHz
CHANNEL 3:	914.4 MHz
Modulation	FM stereo
Power source	DC 9 V: supplied AC power adaptor (AC-GSX100)
Audio input	phono jacks/stereo mini jack

General

Power requirements	
North American models:	120 V AC, 60 Hz
European and Russian models:	230 V AC, 50/60 Hz
Australian model:	230 – 240 V AC, 50/60 Hz
Argentine models:	220 V AC, 50/60 Hz
Mexican models:	127 V AC, 60 Hz
Saudi Arabian model:	120 – 127/220 or 230 – 240 V AC, 50/60 Hz
	Adjustable with voltage selector
Other models:	120 V, 220 V or 230 – 240 V AC, 50/60 Hz
	Adjustable with voltage selector
Power consumption	
USA models:	
MHC-GX750/RX550:	230 watts
MHC-GX450:	265 watts
MHC-GX250:	205 watts
Canadian models:	
MHC-GX750:	280 VA
MHC-GX450:	330 VA
MHC-GX250:	260 VA

European and Russian models:	
MHC-RG444S:	275 watts 0.25 watts (at the Power Saving Mode)
MHC-RG333:	180 watts 0.25 watts (at the Power Saving Mode)
MHC-RG222:	110 watts 0.25 watts (at the Power Saving Mode)
MHC-RG121:	110 watts 0.25 watts (at the Power Saving Mode)
MHC-RG100:	55 watts 0.25 watts (at the Power Saving Mode)
Other models:	
MHC-RG555:	155 watts
MHC-RG551S:	275 watts
MHC-RG444S:	275 watts
MHC-RG441:	155 watts
MHC-RG222:	180 watts
MHC-RG221:	180 watts
MHC-RG121:	110 watts

Dimensions (w/h/d) incl. projecting parts and controls
Amplifier/Tuner/Tape/CD section:

Approx. 280 × 327 ×
425 mm

Transmitter (MHC-GX750 only)

Approx. 136 × 100 ×
103 mm

Mass

North American models:

HCD-GX750:	Approx. 10.5 kg
HCD-GX450:	Approx. 10.0 kg
HCD-GX250:	Approx. 10.0 kg
HCD-RX550:	Approx. 10.5 kg

European, Russian and Australian models:

HCD-RG444:	Approx. 10.0 kg
HCD-RG333:	Approx. 10.0 kg
HCD-RG222:	Approx. 8.5 kg
HCD-RG121:	Approx. 8.5 kg
HCD-RG100:	Approx. 8.0 kg

Other models:

HCD-RG555:	Approx. 10.0 kg
HCD-RG551:	Approx. 10.5 kg
HCD-RG444:	Approx. 10.5 kg
HCD-RG441:	Approx. 10.0 kg
HCD-RG222:	Approx. 10.0 kg
HCD-RG221:	Approx. 10.0 kg
HCD-RG121:	Approx. 8.5 kg

Transmitter (MHC-GX750 only)

Approx. 146 g

Supplied accessories

Remote Commander (1)
R6 (Size AA) batteries (2)
AM loop antenna (1)
FM lead antenna (1)
Transmitter
(MHC-GX750 only) (1)
AC adaptor
(MHC-GX750 only) (1)
Connecting cord phono
plug-stereo miniplug (1m)
(MHC-GX750 only) (1)
Speaker pads
MHC-GX750/GX450/
RG551S/RG444S/
RX550 (12)
MHC-GX250/RG555/
RG441/RG333/RG222/
RG221/RG121/RG100
(8)

Design and specifications are subject to change
without notice.

Sub woofer (MHC-GX750/GX450/RG551S/RG444S/RX550 only)

ALPHABETICAL ORDER

Indicator **1**

SUB WOOFER ON/OFF **2** (21)

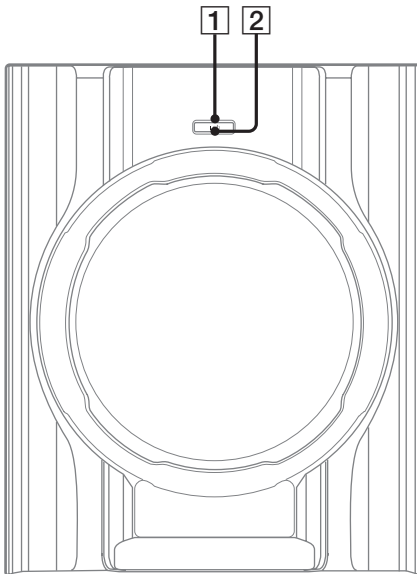

Additional Information

Remote control

ALPHABETICAL ORDER

A - E

- ALBUM -* **13** (12, 14)
- ALBUM +* **11** (12, 14)
- CD **18** (11, 14)
- CLEAR **15** (14)
- CLOCK/TIMER SELECT **2**
(26, 27)
- CLOCK/TIMER SET **3** (10, 25,
26)
- DISC SKIP **10** (12, 14)
- DISPLAY **21** (17, 27, 28)
- ENTER **9** (10, 14, 15, 25, 26)
- EQ **14** (22)

F - Z

- FM MODE **4** (17)
- FUNCTION **6** (11, 14, 15, 16)
- PLAY MODE **20** (12, 14, 18)
- REPEAT **4** (13)
- SLEEP **22** (25)
- TAPE **17**
- TUNER BAND **5** (15, 16)
- TUNER MEMORY **19** (15)
- TUNING MODE **20** (15, 16)
- VOLUME +/- **12** (21, 25)

BUTTON DESCRIPTIONS

- I/⏻ (power) **1** (8, 26)
- ◀◀/▶▶ (rewind/fast forward)
7 (12, 19)
- /+ (tuning) **16** (15)
- ◀◀/▶▶ (go back/go forward)
16 (10, 12, 19)
- ▶ (play) **8** (12, 18)
- ⏸ (pause) **8** (12, 19)
- (stop) **8** (12, 19)

* MHC-GX750/GX450/RG555/
RG551S/RG444S/RG441/
RG333/RG222/RG221/RX550
only

