

Mini Hi-Fi Component System

Operating Instructions

Owner's Record

The model and serial numbers are located on the rear panel of the unit. Record the serial number in the space provided below. Refer to them whenever you call upon your Sony dealer regarding this product.

Model No. _____ Serial No. _____



MHC-GX90D
MHC-RV900D
MHC-RV800D
MHC-RV600D

WARNING

To prevent fire or shock hazard, do not expose the unit to rain or moisture.

To prevent fire, do not cover the ventilation of the apparatus with news papers, table-cloths, curtains, etc. And don't place lighted candles on the apparatus.

To prevent fire or shock hazard, do not place objects filled with liquids, such as vases, on the apparatus.

Do not install the appliance in a confined space, such as a bookcase or built-in cabinet.

The following caution label is located inside the apparatus.

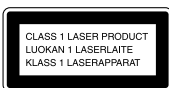

This appliance is classified as a **CLASS 1 LASER** product. This label is located on the rear exterior.

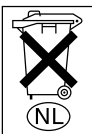

Don't throw away the battery with general house waste, dispose of it correctly as chemical waste.

This system incorporates Dolby® Digital, Pro Logic Surround, DTS®**, and the DTS Digital Surround System.

* Manufactured under license from Dolby Laboratories.

“Dolby”, “Pro Logic”, and the double-D symbol are trademarks of Dolby Laboratories.

** Manufactured under license from Digital Theater Systems, Inc. “DTS” and “DTS Digital Surround” are registered trademarks of Digital Theater Systems, Inc.

NOTICE FOR THE CUSTOMERS IN THE U.S.A.

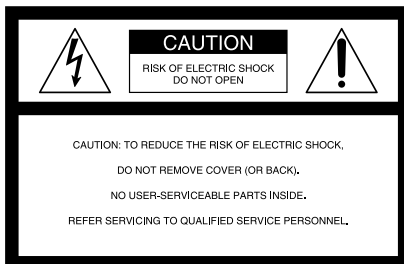

This symbol is intended to alert the user to the presence of uninsulated “dangerous voltage” within the product’s enclosure that may be of sufficient magnitude to constitute a risk of electric shock to persons.



This symbol is intended to alert the user to the presence of important operating and maintenance (servicing) instructions in the literature accompanying the appliance.

CAUTION

The use of optical instruments with this product will increase eye hazard.

As the laser beam used in this CD/DVD player is harmful to eyes, do not attempt to disassemble the cabinet. Refer servicing to qualified personnel only.



This label is located inside the apparatus.

WARNING

This equipment has been tested and found to comply with the limits for a Class B digital device, pursuant to Part 15 of the FCC Rules. These limits are designed to provide reasonable protection against harmful interference in a residential installation. This equipment generates, uses, and can radiate radio frequency energy and, if not installed and used in accordance with the instructions, may cause harmful interference to radio communications. However, there is no guarantee that interference will not occur in a particular installation. If this equipment does cause harmful interference to radio or television reception, which can be determined by turning the equipment off and on, the user is encouraged to try to correct the interference by one or more of the following measures:

- Reorient or relocate the receiving antenna.
- Increase the separation between the equipment and receiver.
- Connect the equipment into an outlet on a circuit different from that to which the receiver is connected.
- Consult the dealer or an experienced radio/TV technician for help.

CAUTION

You are cautioned that any changes or modifications not expressly approved in this manual could void your authority to operate this equipment.

Note to CATV system installer:

This reminder is provided to call the CATV system installer's attention to Article 820-40 of the NEC that provides guidelines for proper grounding and, in particular, specifies that the cable ground shall be connected to the grounding system of the building, as close to the point of cable entry as practical.

NOTICE FOR THE CUSTOMERS IN CANADA

CAUTION

TO PREVENT ELECTRIC SHOCK, DO NOT USE THIS POLARIZED AC PLUG WITH AN EXTENSION CORD, RECEPTACLE OR OTHER OUTLET UNLESS THE BLADES CAN BE FULLY INSERTED TO PREVENT BLADE EXPOSURE.

Except for European model



ENERGY STAR® is a U.S. registered mark. As an ENERGY STAR® Partner, Sony Corporation has determined that this product meets the ENERGY STAR® guidelines for energy efficiency.

IMPORTANT NOTICE

Caution: This system is capable of holding a still video image or on-screen display image on your television screen indefinitely. If you leave the still video image or on-screen display image displayed on your TV for an extended period of time, you risk permanent damage to your television screen. Projection televisions are especially susceptible to this.

About this manual

The North American model is the model used for OSD (on-screen display) illustration purposes.

Table of Contents

List of Button Locations and Reference Pages

Main unit	8
Remote control	9
Sub woofer (MHC-GX90D and RV800D only)	10

Getting Started

Hooking up the system	11
Inserting two R6 (size AA) batteries into the remote	16
Setting the clock	16

DVD/VIDEO CD/CD/MP3

Playing discs

Loading a disc	17
Playing a disc — Normal Play/Shuffle Play/ Slow-motion Play	17
Creating your own program — Program Play	20
Resuming playback from the point you stopped the disc — Resume Play	22
Playing repeatedly — Repeat Play	23
Playing a disc with MP3 audio tracks	25
Playing DVDs using the menu	26
Playing VIDEO CDs with PBC functions (Ver. 2.0) — PBC Play	27

Setting up for DVD/VIDEO CD/CD/MP3

Using the Setup Display	28
Setting the display or sound track language — LANGUAGE SETUP	29
Settings for the display — SCREEN SETUP	29
Custom settings — CUSTOM SETUP	30
Speaker settings — SPEAKER SETUP	31

Sound adjustment

Changing the sound	34
--------------------------	----

Enjoying movies

Searching for a title/chapter/track/index	36
Changing the angles (DVD only)	37
Displaying the subtitles (DVD only)	38

Using various additional functions

Locking discs — CUSTOM PARENTAL CONTROL/ PARENTAL CONTROL	38
---	----

Tuner

Presetting radio stations	43
Listening to the radio — Preset Tuning	44
— Manual Tuning	45
Using the Radio Data System (RDS) (European model only)	45

Tape

Loading a tape	47
Playing a tape	47
Recording to a tape — CD Synchro Recording/Recording Manually/Program Edit	48
Timer-recording radio programs	50

Sound Adjustment

Adjusting the sound	51
Selecting the sound effect	51
Adjusting the graphic equalizer and storing	52
Using the sub woofer (MHC-GX90D and RV800D only)	53
Selecting the surround effect	53

Display

Turning off the display — Power Saving Mode	53
Viewing information about the disc	54

Other Features

Enhancing video game sound — Game Sync	56
Mixing video game sound with other sound source — Game Mixing	56
Changing the spectrum analyzer display	57
Adjusting the brightness of the indicators ...	57
Singing along: Karaoke (MHC-RV900D and RV600D only)	57
Falling asleep to music — Sleep Timer	59
Waking up to music — Daily Timer	59

Optional Components

Hooking up optional components	61
Listening to audio from a connected component	62
Recording on a connected component	63
Recording audio from a connected component	63

Troubleshooting

Problems and remedies	64
Messages	68
Self-diagnosis function	69

Additional Information

Precautions	69
Specifications	71
Glossary	74
Language code list	77
Control Menu item list	78
Setup Display item list	79

This system can play the following discs

	DVD VIDEOS	Audio CDs	VIDEO CDs
Disc logo			
Contents	Audio + Video	Audio	Audio + Video

The “DVD VIDEO” logo is a trademark.

Discs that this system cannot play

- CD-ROMs (PHOTO CDs included)
- CD-Rs/CD-RWs other than those recorded in the following formats:
 - music CD format
 - video CD format
 - MP3 format that conforms to ISO9660*
Level 1/Level 2, or its extended format, Joliet

- Data part of CD-Extras
- DVD-ROMs
- DVD Audio discs

* A logical format of files and folders on CD-ROMs, defined by ISO (International Standard Organization)

The system also cannot play the following discs:

- A DVD with a different region code.
- A disc that has a non-standard shape (e.g., card, heart).
- A disc with paper or stickers on it.
- A disc that has the adhesive, cellophane tape, or a sticker still left on it.

Note

Some CD-Rs/CD-RWs or DVD-Rs/DVD-RWs cannot be played on this system depending upon the format or the recording quality or physical condition of the disc, or the characteristics of the recording device.

Furthermore, the disc will not play if it has not been correctly finalized. For more information, see the operating instructions for the recording device.

Region code of DVDs you can play on this system

Your system has a region code printed on the back of the unit and will only play DVDs labeled with identical region code.

DVDs labeled  will also be played on this system.

If you try to play any other DVD, the message “Playback prohibited by area limitations.” will appear on the TV screen.

Depending on the DVD, no region code indication may be labeled even though playing the DVD is prohibited by area restrictions.

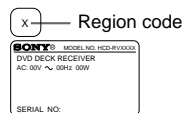

Note on playback operations of DVDs and VIDEO CDs

Some playback operations of DVDs and VIDEO CDs may be intentionally set by software producers. Since this system plays DVDs and VIDEO CDs according to the disc contents the software producers designed, some playback features may not be available. Also, refer to the instructions supplied with the DVDs or VIDEO CDs.



Note on VIDEO CDs

This system conforms to VIDEO CDs without PBC* functions (Ver. 1.1) and VIDEO CDs with PBC functions (Ver. 2.0) of VIDEO CD standards. You can enjoy two kinds of playback according to the disc type.

Disc type	You can
VIDEO CDs without PBC functions (Ver. 1.1 discs)	Enjoy video playback (moving pictures) as well as audio CDs.
VIDEO CDs with PBC functions (Ver. 2.0 discs)	Play interactive software using menu screens displayed on the TV screen (menu playback), in addition to the video playback function of VIDEO CDs without PBC functions. Moreover, you can play high or standard quality still picture.

* PBC = Play Back Control

Notes on CD-R and CD-RW discs

Type of discs	Label on the disc
Audio CD	
MP3 files	

- Discs recorded on CD-R/CD-RW drives may not be played back because of scratches, dirt, recording condition or the drive's characteristics.
- You cannot play a CD-R/CD-RW that is not finalized.
- Playback of multi-session CD-R/CD-RWs recorded as Audio CDs is not supported.

Copyrights

This product incorporates copyright protection technology that is protected by method claims of certain U.S. patents, other intellectual property rights owned by Macrovision Corporation, and other rights owners. Use of this copyright protection technology must be authorized by Macrovision Corporation, and is intended for home and other limited viewing uses only unless otherwise authorized by Macrovision Corporation. Reverse engineering or disassembly is prohibited.

How to use this page

Use this page to find the location of buttons and other parts of the system that are mentioned in the text.

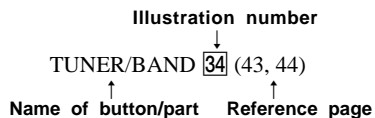

Main unit

ALPHABETICAL ORDER

A - J

- ALBUM+/- **22** (19, 20, 26)
- AUDIO jacks **29** (61)
- CD SYNC **19** (48, 50)
- Deck A **25** (47)
- Deck B **18** (47, 48, 49, 50, 58)
- DIRECTION **8** (47, 48, 50, 58)
- DISC 1 - 3 **12** (18, 19, 20)
- DISC SKIP/EX-CHANGE **13** (17, 19, 23)
- Disc tray **11** (17)
- DISPLAY **8** (45, 53, 54, 55)
- DVD **35** (18, 20, 26, 27, 36, 48, 49)
- DVD DISPLAY **10** (18, 24, 34, 36, 37, 38, 41, 55)
- DVD MENU **8** (26)
- DVD TOP MENU **8** (26)
- ECHO LEVEL control*¹ **28** (58)
- EFFECT ON/OFF **4** (51, 52)
- ENTER **14** (16, 18, 20, 24, 26, 27, 34, 36, 37, 38, 43, 46, 49, 50, 52, 55, 57, 59)
- FM MODE **8** (45)
- GAME **31** (56, 61)
- GAME EQ **23** (51)
- GAME MIXING **24** (56)
- GROOVE **3** (51)

K - Z

- KARAOKE PON*¹ **2** (57)
- MD (VIDEO)*² **32** (62)
- MIC jack*³ **27** (57)
- MIC LEVEL control*³ **28** (57)
- MOVIE EQ **9** (51)
- MUSIC EQ **6** (51)
- P FILE **21** (52)
- PHONES jack **16**
- PLAY MODE **8** (18, 20, 49)
- REC PAUSE/START **20** (48, 50, 58)
- REPEAT **8** (23)
- SURROUND*⁵ **5** (53)
- TAPE A/B **33** (47, 48, 58)
- TUNER MEMORY **8** (43)
- TUNER/BAND **34** (43, 44)
- VIDEO jack **30** (61)
- VIDEO (MD)*⁶ **32** (62)
- VOLUME control **15** (33, 53, 59)

BUTTON DESCRIPTIONS

- I/O (power) **1**
- ▲▼/▶◀ **7**
- ▲ OPEN/CLOSE **13**
- ▲ PUSH (deck B) **17**
- ◀◀▶▶ + **22**
- ▶▶◀◀ **22**
- ◀◀/▶▶ **22**
- **22**
- **22**
- ▲ PUSH (deck A) **26**

*¹ MHC-RV900D and RV600D only

*² except for MHC-GX90D

*³ MHC-RV900D and RV600D only

*⁴ European model only

*⁵ MHC-RV600D only

*⁶ MHC-GX90D only

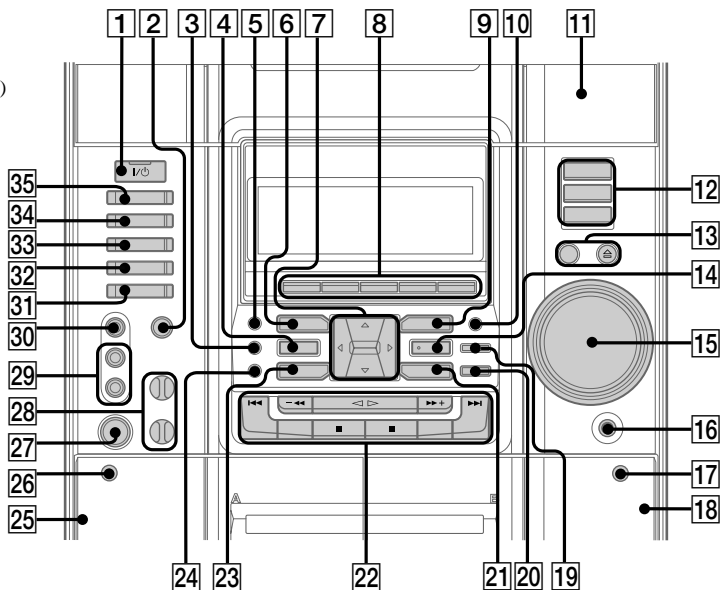

Remote control

ALPHABETICAL ORDER

A - M

- ALBUM +/- **23** **29** (19, 20, 26)
- AMP MENU **21** (57)
- ANGLE **20** (37)
- AUDIO **33** (35)
- CLEAR **14** (20, 22, 24, 31)
- CLOCK/TIMER SELECT **2** (51, 60)
- CLOCK/TIMER SET **3** (16, 50, 59)
- DISC +/- **25** **27** (19, 20, 23)
- DISPLAY **11** (45, 53, 54, 55)
- DVD **43** (18, 20, 21, 26, 27, 28, 36, 48, 49)
- DVD DISPLAY **13** (18, 24, 34, 36, 37, 38, 41, 55)
- DVD MENU **34** (26)
- DVD SETUP **38** (28, 33, 40)
- DVD TOP MENU **34** (26)
- EFFECT ON/OFF **32** (51, 52)
- ENTER **28** (16, 18, 20, 21, 24, 26, 27, 28, 33, 34, 36, 37, 38, 40, 43, 46, 49, 50, 52, 55, 57, 59)
- GAME **8** (56, 61)
- GAME EQ **30** (51)
- GAME MIXING **10** (56)
- GROOVE **32** (51)
- MD (VIDEO) **9** (62)
- MOVIE EQ **30** (51)
- MULTI ROOM* **31**
- MUSIC EQ **30** (51)

N - Z

- NEXT **36** (18, 27)
- Number buttons **12** (19, 27, 39, 40, 42, 49)
- P FILE **22** (52)
- PLAY MODE **41** (18, 20, 21, 49)
- PRESET +/- **36** (43, 44)
- PREV **36** (18, 27)
- REPEAT **40** (23)
- RETURN **37** (27, 39, 41)
- SCAN/SLOW **18** (19)
- SLEEP **1** (59)
- SUBTITLE **19** (38)
- SURROUND **32** (53)
- TAPE **44** (47, 48)
- TUNER/BAND **42** (43, 44)
- TUNING +/- **35** (43, 45)
- TV I/⏻ **4** (15)
- TV CH +/- **45** (15)
- TV/VIDEO **7** (15)
- TV VOL +/- **6** (15)
- VOL +/- **24** (33, 53, 59)

BUTTON DESCRIPTIONS

- I/⏻ (power) **5**
- **15**
- ◀▶ **16**
- ⏮ **17**
- ⬆️/⬇️/⬇️/⬆️ **26**
- ⏪ **35**
- ⏩ **35**
- ⏮ **36**
- ⏭ **36**
- >10* **39**

* This button does not function.

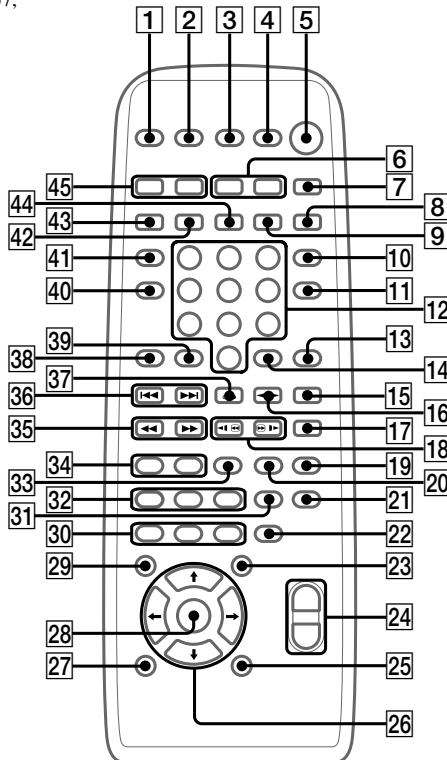

Sub woofer

(MHC-GX90D and RV800D only)

ALPHABETICAL ORDER

A - Z

Indicator **1** (53)

ON/OFF **2** (53)

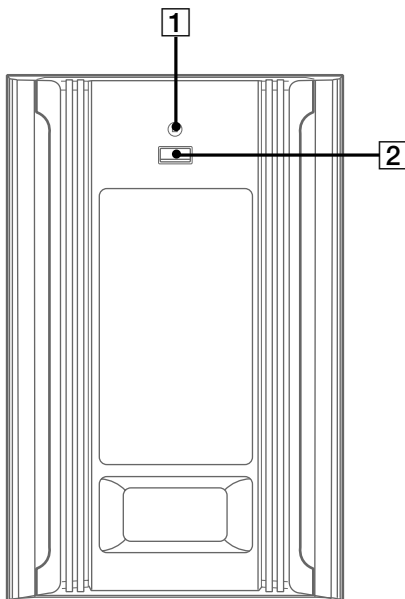

Hooking up the system

Perform the following procedures **1** to **8** to hook up your system using the supplied cords and accessories.

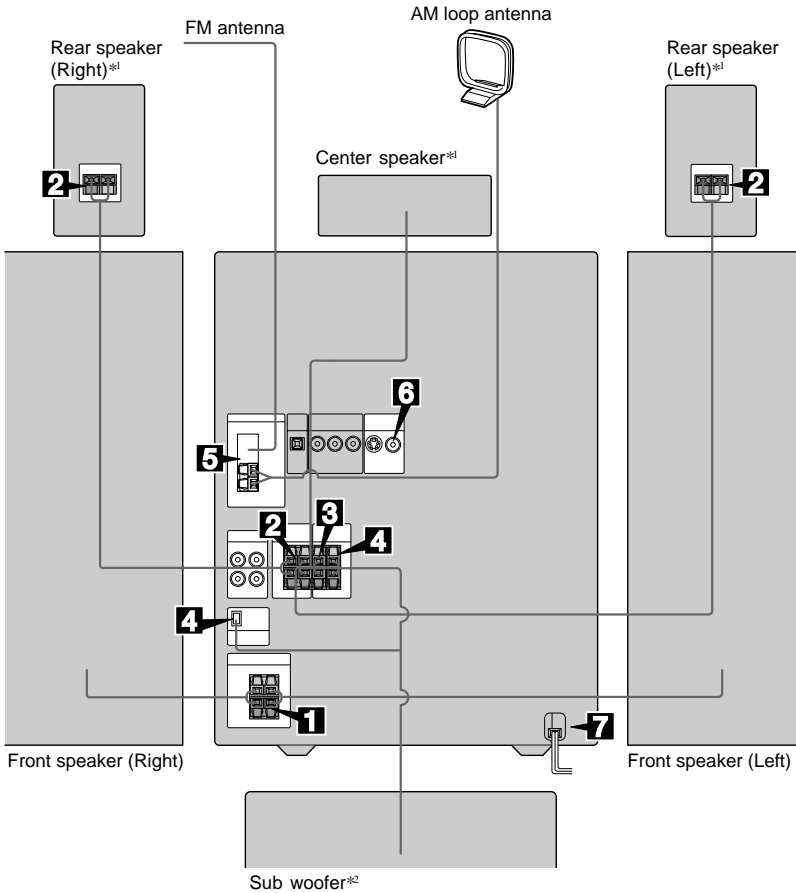

*1 except for MHC-RV600D

*2 MHC-GX90D and RV800D only

continued

Hooking up the system (continued)

1 Connect the front speakers.

Connect the speaker cords to the FRONT SPEAKER jacks as shown below.

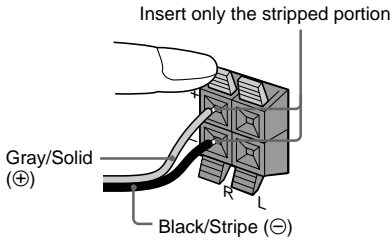

2 Connect the rear speakers. (except for MHC-RV600D)

Connect the speaker cords to the REAR SPEAKER jacks as shown below.

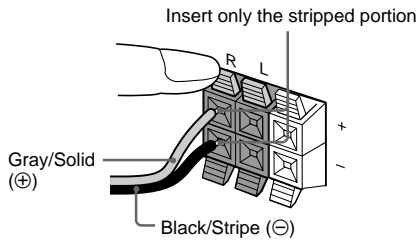

3 Connect the center speaker. (except for MHC-RV600D)

Connect the speaker cords to the CENTER SPEAKER jacks as shown below.

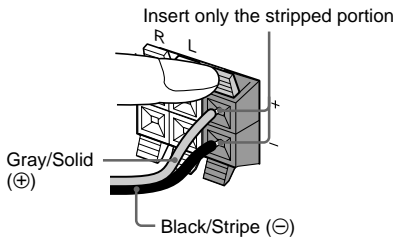

4 Connect the sub woofer speaker. (MHC-GX90D and RV800D only)

Connect the speaker cords to the SUB WOOFER jack and SUB WOOFER CONTROL jack as shown below.

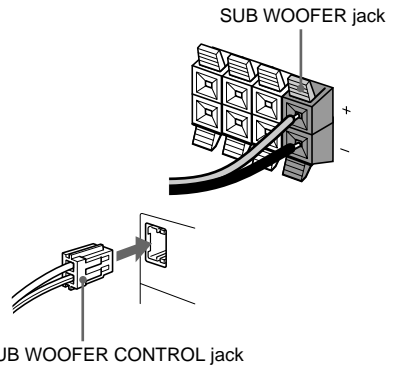

5 Connect the FM/AM antennas.

Set up the AM loop antenna, then connect it.

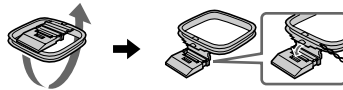

Jack type (A) (except for MHC-RV800D)

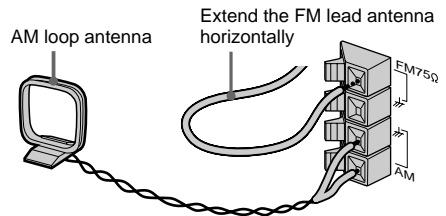

Jack type (B) (MHC-RV800D only)

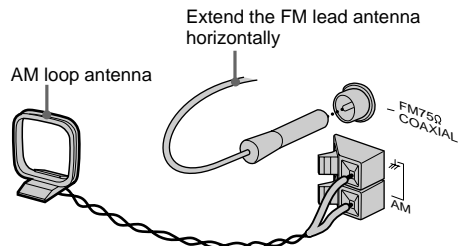

- 6** Connect the video input jack of your TV to the VIDEO OUT jack with the supplied video cable.

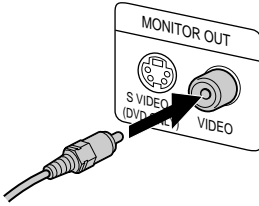

When using a TV

Turn on the TV and select the video input so that you can view the pictures from this system.

Tip

For even higher quality video images, you can use an optional S-video cable to connect the S VIDEO input jack on your TV to the S VIDEO OUT jack (DVD only).

- 7** Connect the power cord to a wall outlet.

The demonstration appears in the display. When you press **I/⏻**, the system turns on and the demonstration automatically ends.

- 8** Set the color system to PAL or NTSC depending on the color system of your TV.

The color system is factory set to NTSC for region code 3 models, and PAL for other region code models. Each time you perform the procedure below, the color system changes as follows:

NTSC ↔ PAL

Use the buttons on the system.

- 1** Press **I/⏻** to turn off the system.

- 2** Press **I/⏻** while holding down **II**.

The system turns on and the color system is changed.

Notes

- You cannot set the color system in the Power Saving Mode.
- When you play back a VIDEO CD recorded in a different color system from the one you set to the unit, the picture image may be distorted.

To connect optional components

See page 61.

continued

Hooking up the system (continued)

To attach the speaker pads

Attach the supplied speaker pads to the bottom of the speakers to stabilize the speakers and prevent them from slipping.

Front speaker (Left (4)/Right (4))

Sub woofer*1 (4)

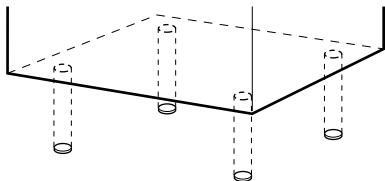

Center speaker*2 (2)

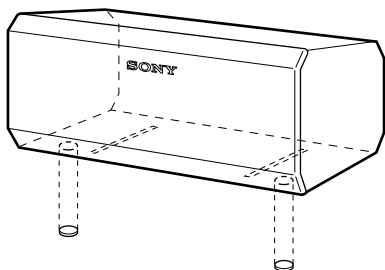

Speaker pads are not supplied for the rear speakers.

Notes

- Keep the speaker cords away from the antennas to prevent noise.
- The type of speakers supplied vary according to the model you purchased (see "Specifications" on page 71).
- Do not place the rear speakers on top of a TV.*2 This may cause distortion of the colors in the TV screen.
- Be sure to connect both left and right rear speakers.*2 Otherwise, the sound will not be heard.

*1 MHC-GX90D and RV800D only

*2 except for MHC-RV600D

Positioning the speakers (except for MHC-RV600D)

1 Place the front speakers at an angle of 45 degrees from your listening position.

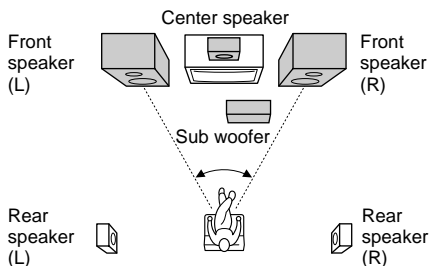

2 Place the center speaker at about the same height as the front speakers. Align the center speaker with the front speakers or place it slightly behind the front speakers.

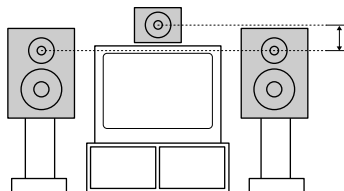

3 Place the rear speakers facing each other at about 60 to 90 cm above your listening position.

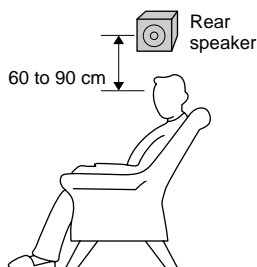

Placing the sub woofer (MHC-GX90D and RV800D only)

Since the human ear cannot detect the direction and position where the bass sound being reproduced by a woofer (below 150 Hz) comes from, you can place the woofer wherever you like in your room. To obtain a better bass reproduction, we recommend you to place the woofer on a solid floor where resonance is unlikely to occur.

Tip

You can enjoy 5.1 channel surround sound while playing a DVD. To adjust the speaker volume and level, see page 33.

Notes

- Always place the woofer vertically, keeping it a few centimeters away from the wall.
- If the woofer is placed in the center of a room, the bass could be extremely weakened. This is due to the influence of the standing wave of the room. If this happens, move the woofer away from the center of the room or eliminate the cause of the standing wave, by placing a bookshelf against the wall, etc.

Using the remote

You can use the buttons shown below to operate a Sony TV.

To	Press
Turn the TV on or off	TV I/⏻
Switch the TV's video input	TV/VIDEO
Change the TV channels	TV CH + or –
Adjust the volume of the TV speaker(s)	TV VOL + or –

When carrying this system

Perform the following procedure to protect the DVD mechanism.

- 1** Press I/⏻ to turn on the system, then press DVD. Make sure that all discs are removed from the system.
- 2** Hold down DVD, then press I/⏻ until "STANDBY" appears. When you release the buttons, "LOCK" appears.
- 3** Unplug the power cord.

Inserting two R6 (size AA) batteries into the remote

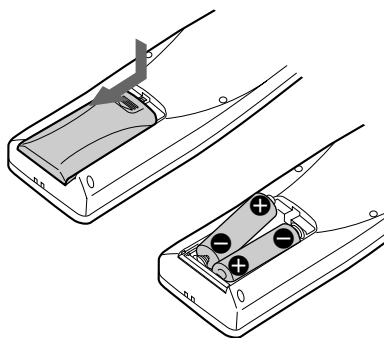

Tip

With normal use, the batteries should last for about six months. When the remote no longer operates the system, replace both batteries with new ones.

Note

If you do not use the remote for a long period of time, remove the batteries to avoid possible damage from battery leakage.

Setting the clock

- 1 Press **I/⏻** to turn on the system.
- 2 Press **CLOCK/TIMER SET** on the remote.
- 3 Press **↑** or **↓** on the remote repeatedly to set the hour.
- 4 Press **→** on the remote.
The minute indication flashes.
- 5 Press **↑** or **↓** on the remote repeatedly to set the minute.
- 6 Press **ENTER**.
The clock starts working.

To adjust the clock

- 1 Press **CLOCK/TIMER SET** on the remote.
- 2 Press **↑** or **↓** on the remote repeatedly to select "CLOCK SET", then press **ENTER**.
- 3 Do the same procedures as step 3 to 6 above.

Note

The clock settings are canceled when you disconnect the power cord or if a power failure occurs.

Playing discs

Loading a disc

You can also load and play discs with MP3 audio tracks. See “Playing a disc with MP3 audio tracks” on page 25 for MP3.

1 Press \blacktriangle OPEN/CLOSE.

The disc tray opens.

2 Place a disc with the label side up on the disc tray.

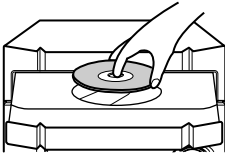

To insert additional discs, press DISC SKIP/EX-CHANGE to rotate the disc tray.

3 Press \blacktriangle OPEN/CLOSE to close the disc tray.

Playing a disc

— Normal Play/Shuffle Play/Slow-motion Play

You can play up to three discs (DVD, VIDEO CD, CD or MP3) in a row. Depending on the DVD or VIDEO CD, some operations may be different or restricted. Refer to the operating instructions supplied with the disc.

When playing a DVD:

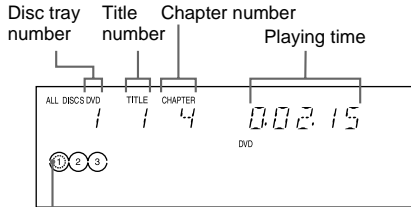

Disc presence indicator

When playing a VIDEO CD:

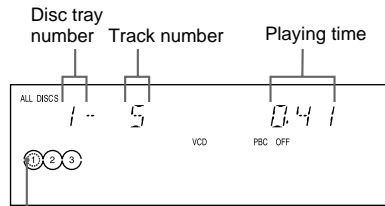

Disc presence indicator

When playing a CD:

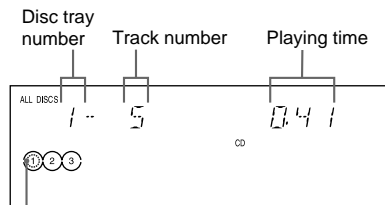

Disc presence indicator

continued

Playing a disc (continued)

When playing MP3 audio tracks:

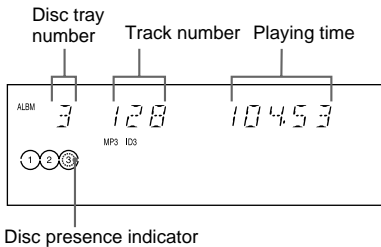

1 Turn on your TV and select the video input.

Refer to the operating instructions supplied with your TV if you need help.

2 Press DVD.

3 Press PLAY MODE repeatedly in stop mode until the mode you want appears in the display.

Select	To play
ALL DISCS (Normal Play)	All discs in the disc tray continuously.
IDISC (Normal Play)	The tracks on the disc you have selected in original order.
ALBM (Normal Play)	All MP3 audio tracks in the album on the disc you have selected in original order.
ALL DISCS SHUF (Shuffle Play)*	The tracks on all discs in random order.
IDISC SHUF (Shuffle Play)*	The tracks on the disc you have selected in random order.
ALBM SHUF (Shuffle Play)*	The MP3 audio tracks in the album on the disc you have selected in random order.
PGM (Program Play)*	The tracks on all discs in the order you want them to be played (see "Creating your own program" on page 20).

* You cannot perform Shuffle Play and Program Play with DVDs.

4 Press one of the DISC 1 – 3 buttons.

If you press ◀▶ (or ◀▶ on the remote) when DVD function is selected and the disc tray is closed, playback starts from the selected disc.

Tip

You can change the play mode between 1 DISC, ALL DISCS and ALBM using the on-screen display as follows:

- 1 Press DVD DISPLAY in stop mode. The Control Menu appears.
- 2 Press ▲ or ▼ (or ↑ or ↓ on the remote) to select "PLAY MODE", then press ENTER.
- 3 Press ▲ or ▼ (or ↑ or ↓ on the remote) to select desired play mode, then press ENTER.

Notes

- "ALBM" or "ALBM SHUF" appears even if you have selected a non-MP3 disc or MP3 disc with no albums. In this case, the disc is played in the "IDISC" or "IDISC SHUF" play mode, respectively.
- You cannot perform "IDISC SHUF" and "ALBM SHUF" with DVDs.

Other Operations

To	Do this
Stop play	Press ■. The playback stops at the point ■ is pressed (Resume Play). Press ■ again to cancel the Resume Play (see page 22).
Pause	Press ■*1. Press again to resume play.
Select a track or chapter	During play or pause, press ►► (or NEXT on the remote) (to go forward) or ◀◀ (or PREV on the remote) (to go back).
Find a point in a track or chapter (Lock Search*2)	Press ►► or ◀◀ during play. At the desired point, press ◀▶ (or ◀▶ on the remote) to stop searching and start playback. For DVDs or VIDEO CDs, each time you press ►► or ◀◀, the speed changes as follows: 1 (slow) ↔ 2 (faster than 1)

To	Do this
Select an album of MP3	Press ALBUM – or + repeatedly after step 3.
Change the playback speed* ¹ (Slow-motion Play) (DVD/VCD only)	During pause, press SCAN/SLOW ◀▶ or ▶▶* ³ on the remote. Each time you press the button, the speed switches between two slowed play speeds. To return to Normal Play, press ◀▶ (or ▶▶ on the remote).
Select a disc in stop mode	Press one of the DISC 1 – 3 buttons or DISC SKIP/EX-CHANGE (or DISC +/- on the remote).
Switch to DVD function from another source	Press one of the DISC 1 – 3 buttons (Automatic Source Selection).
Exchange other discs while playing	Press DISC SKIP/EX-CHANGE.
Remove a disc	Press ▲ OPEN/CLOSE.

*¹ There may be some disturbance in the video image.

*² except for MP3

*³ Slow-motion reverse play for DVD only.

Notes

- Depending on the DVD or VIDEO CD, some operations may be prohibited.
- 2 channel sound is heard when using headphones (MHC-GX90D and RV800D only).

Playing a track by entering the track number (on the remote only)

Press the number button(s) on the remote to enter the track number of the track you want to play. (To enter the MP3 track number, press ALBUM – or + repeatedly to select the desired album before entering the number.)

To enter a track number over 10

1 Enter the corresponding digits.

To enter 0, press 10/0.

2 Press ENTER.

Example:

To play track number 30, press 3 and 10/0, then press ENTER.

To play MP3 track number 100, press 1, 10/0 and 10/0, then press ENTER.

Creating your own program

— Program Play

You can make a program of up to 25 steps from all discs except DVD in the order you want them to be played.

Using the front panel display

- 1 Press DVD.
- 2 In stop mode, press PLAY MODE repeatedly until “PGM” appears in the display.
- 3 Press one of DISC 1 – 3 (or DISC + or – on the remote) to select a disc.
- 4 Press ◀▶ or ▶▶ until the desired track appears in the display.

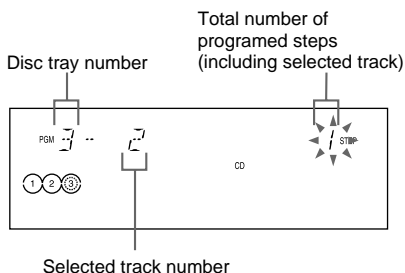

5 Press ENTER.

The track is programmed.

6 Program additional discs or tracks.

To program	Repeat steps
Other tracks on the same disc	4 and 5
Other tracks on other discs	3 to 5

7 Press ◀▶ (or ▶▶ on the remote).

Other Operations

To	Do this
Cancel Program Play	Press PLAY MODE repeatedly until “PGM” and “SHUF” disappear.
Clear a track from the end of program	Press CLEAR on the remote in step 2.

To program MP3 audio tracks

After step 3, press ALBUM – or + repeatedly until the album you want appears, and then go to step 4.

Tip

The program you made remains in the system’s memory even after Program Play finishes. To play the same program again, press DVD, then press ◀▶ (or ▶▶ on the remote).

Using the on-screen display

Use the remote for the operation.

- 1 Press DVD.
- 2 In stop mode, press **PLAY MODE** repeatedly until “PGM” appears in the display.

The Program Display appears on the screen.

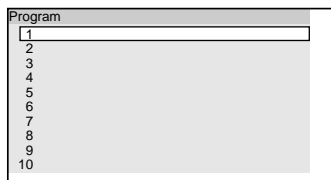

- 3 Press **→**, then press **↑** or **↓** repeatedly to select the disc.

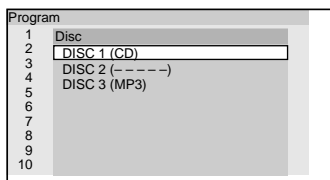

- 4 Press **→**.

The cursor moves to the album or track (in this case, “DISC 1”).

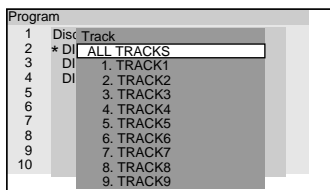

* “?” appears when the system has not loaded the disc information in the memory.

- 5 Select the album, or track you want to program.

■ When programming a VIDEO CD or CD

For example, select track “6”.

Press **↑/↓** or the number buttons to select “6”, then press **ENTER**.

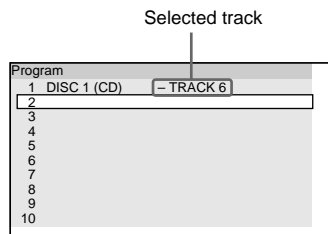

■ When programming MP3

For example, select track “3” of album “2”.

Press **↑/↓** or the number buttons to select “2”, then press **→**.

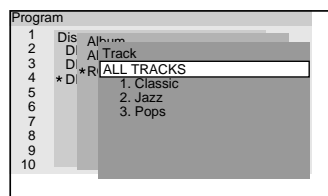

Next, **↑/↓** or the number buttons to select “3”, then press **ENTER**.

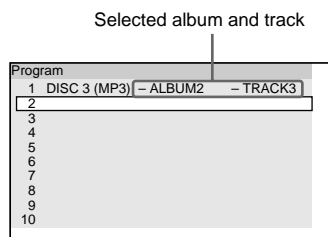

continued

Creating your own program (continued)

6 To program other discs, albums, or tracks, repeat steps 3 to 5.

7 Press ◀▶.

Program Play starts.

Other Operations

To	Do this
Return to normal playback	Press CLEAR during playback.
Turn off the Program Display	Press PLAY MODE when the Program Play is stopped.
Clear a track from the end of program	Press CLEAR in step 2.

Tip

The program you made remains in the system's memory even after Program Play finishes. Press ◀▶ to play the same program again.

Note

When you switch the play mode to "PGM" while "REP 1" is selected, "REP 1" is automatically canceled.

Resuming playback from the point you stopped the disc

— Resume Play

The system memorizes the point where you stopped the disc so that you can resume from that point. Resume Play is not canceled when you turn off the system.

1 While playing a disc, press ■ to stop playback.

"RESUME" appears in the display. If "RESUME" does not appear, Resume Play is not available.

2 Press ◀▶ (or ◀▶ on the remote).

Playback starts from the point you stopped the disc in step 1.

To play from the beginning of the disc

When "RESUME" appears in the display, press ■, then press ◀▶ (or ◀▶ on the remote).

For a disc containing MP3 audio tracks, press ■ one more time to return to the first album.

Notes

- Depending on where you stopped the disc, the player may resume playback from a different point.
- Resume Play is canceled when:
 - you press the number buttons, PLAY MODE, ■, DISC SKIP/EX-CHANGE (or DISC +/- on the remote) or ◀◀/▶▶.
 - you remove the disc.
 - you unplug the system's power cord.

Playing repeatedly

— Repeat Play

You can repeatedly play all the titles/tracks/albums or a single title/chapter/track/album on a disc.

In Shuffle or Program Play mode, the system repeats the titles or tracks in the shuffled or programmed order.

Using the front panel display

Press REPEAT during play until “REP” or “REP 1” appears.

REP: For all the tracks on the disc up to five times.

REP 1: For a single track only.

To cancel Repeat Play

Press REPEAT repeatedly until “REP” and “REP 1” disappear.

Tips

- You cannot select “REP” and “ALL DISCS SHUF” at the same time.
- When you select “REP 1”, that track is repeated endlessly until “REP 1” is canceled.

Note

You cannot perform Repeat Play during PBC playback of VIDEO CDs (see page 27).

continued

Playing repeatedly (continued)

Using the on-screen display

Use the remote for the operation.

1 Press DVD DISPLAY.

The Control Menu appears.

2 Press ▲ or ▼ repeatedly to select “REPEAT”, then press ENTER.

3 Select the Repeat Play setting.

■ Playing a DVD

- OFF: does not play repeatedly.
- ALL: repeats all the titles.
- TITLE: repeats the current title on a disc.*
- CHAPTER: repeats the current chapter.

■ Playing a VIDEO CD/CD when Program Play is set to OFF

- OFF: does not play repeatedly.
- ALL: repeats all the tracks on a disc.
- TRACK: repeats the current track.*

■ Playing MP3 when Program Play is set to OFF

- OFF: does not play repeatedly.
- ALL: repeats all the tracks on a current disc, or all the tracks in a current album when “CONTINUE (ALBUM)” is selected.
- TRACK: repeats the current track.

■ When Program Play is set to ON

- OFF: does not play repeatedly.
- ALL: repeats Program Play.

* When “ALL DISCS SHUFFLE” is selected, you can select the Repeat Play of “TITLE”, “CHAPTER” or “TRACK” only.

To cancel Repeat Play
Press CLEAR.

Tips

- You can set Repeat Play when the playback is stopped. After selecting the “REPEAT” item, press ◀▶ to start Repeat Play.
- You can quickly display the “REPEAT” status. Press REPEAT.

Notes

- You cannot perform Repeat Play during PBC playback of VIDEO CDs (see page 27).
- You can perform Repeat play for DVD titles that contain chapters.
- If you select ALL repeat, the program is repeated up to 5 times.

Playing a disc with MP3 audio tracks

About MP3

MP3 (MPEG 1 Audio Layer-3) is a standard technology and format for compressing a sound sequence. The file is compressed to about 1/10 of its original size. Sounds outside the range of human hearing are compressed while the sounds we can hear are not compressed.

Notes on discs

You can play MP3 audio tracks recorded on CD-ROMs, CD-Rs (recordable CDs), and CD-RWs (rewritable CDs).

The disc must be in the ISO 9660* level 1 or level 2 format, or Joliet in the expansion format.

* ISO 9660 Format

The most common international standard for the logical format of files and folders on a CD-ROM. There are several specification levels. In Level 1, file names must be in the 8.3 format (no more than eight characters in the name, no more than three characters in the extension “.MP3”) and in capital letters. Folder names can be no longer than eight characters. There can be no more than eight nested folder levels. Level 2 specifications allow file names and folder names up to 31 characters long. Each folder can have up to 8 trees.

For Joliet in the expansion format (file and folder names can have up to 64 characters), make sure of the contents of the writing software, etc.

Notes

- Only the letters in the alphabet and numbers can be used for album or track names. Anything else is displayed as “ ” (space).
- When naming, be sure to add the file extension “MP3” to the file name.
- If you put the extension “MP3” to a file other than MP3, the unit cannot recognize the file properly and will generate random noise that could damage your speakers.
- The following discs take a longer time to start playback.
 - a disc recorded with complicated tree structure.
- Depending on the encoding/writing software, recording device, or the recording media used at the time an MP3 file is recorded, you may encounter such problems as disabled playback, sound interruptions, and noise.

continued

Playing a disc with MP3 audio tracks (continued)

Listening to MP3 audio tracks

You can play discs with MP3 audio tracks on this system.

- 1 Press **DVD**.
- 2 Press **ALBUM** – or + repeatedly to select the desired album.
Proceed to step 4 when you start playing from the first track in the album.
- 3 When you want to specify a track in the album, press **◀◀** or **▶▶** repeatedly to select the desired track.
- 4 Press **◀▶** (or **◀▶** on the remote).

Tip

You can perform the operations described under “Playing a disc” on page 17 and “Creating your own program” on page 20 only for the tracks in the album.

Note

When playing back MP3, the elapsed playing time and remaining time indication may differ from the actual time in the following case.

- When you play back a VBR (variable bit rate) MP3 audio track

Playing DVDs using the menu

Using the DVD's menu

A DVD is divided into long sections of a picture or a music feature called “titles”. When you play a DVD which contains several titles, you can select the title you want using the DVD TOP MENU button.

Some DVDs allow you to select the disc contents using a menu. When you play DVDs that allow you to select items such as the language for the subtitles and the language for the sound, select these items using the DVD MENU button.

- 1 Press **DVD**.
- 2 Press **DVD TOP MENU** or **DVD MENU**.
The DVD's menu appears on the TV screen. The contents of the menu vary from disc to disc.
- 3 Press **▲/▼/◀/▶** (or **↑/↓/←/→** on the remote) or the number buttons to select the item you want to play or change.
- 4 Press **ENTER**.

Playing VIDEO CDs with PBC functions (Ver. 2.0)

— PBC Play

You can use menus on your TV screen to enjoy the disc's interactive software. The menu format and structure may differ depending on each disc.

1 Press DVD.





2 Press (or on the remote) to start playing a VIDEO CD with PBC functions (Ver. 2.0).

The VIDEO CD and PBC indicators light up and a PBC menu appears on your TV.

- VCD: Lights during playback of a VIDEO CD.
- PBC: Lights during PBC playback of a PBC compatible VIDEO CD (Ver. 2.0).

3 Press or (or or on the remote) repeatedly to select a number from the menu, then press ENTER.

4 Continue playback according to the instructions on the menus to enjoy interactive playback.

To	Do this
Stop play	Press  .
See the rest of a menu	Press NEXT on the remote.
Go back to the top of a menu	Press PREV on the remote.
Go back to a previous menu	Press RETURN  on the remote.
Cancel playback with PBC functions (Ver. 2.0)	In stop mode, press  or  repeatedly to select the desired track, then press ENTER (or press the number buttons on the remote).
Select a menu number using the remote	Press the number buttons on the remote, then press ENTER. To enter 0, press 10/0 on the remote.

Note

Depending on the VIDEO CD, "Press ENTER" in step 3 may appear as "Press SELECT" in the operating instructions supplied with the disc.

Using the Setup Display

By using the Setup Display, you can make various adjustments to items such as picture and sound. You can also set a language for the subtitles and the Setup Display, among other things. For details on each Setup Display item, see pages 29 – 42. For an overall list of Setup Display items, see page 79.

Use the remote for the operation.

1 Press DVD.

2 Press DVD SETUP in stop mode.

The Setup Display appears.

3 Press **↑** or **↓** repeatedly to select the setup item from the displayed list, then press **ENTER**.

The selected setup item appears.

Example: “SCREEN SETUP”

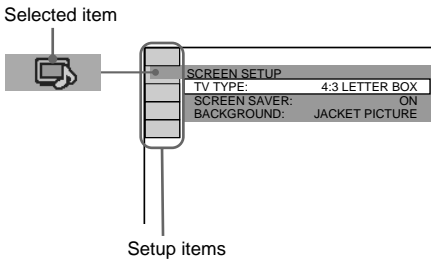

4 Press **↑** or **↓** repeatedly to select an item, then press **ENTER**.

The options for the selected item appear.

Example: “TV TYPE”

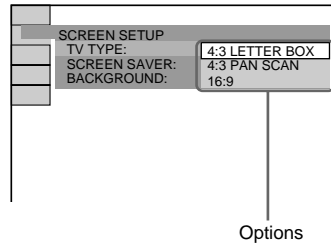

5 Press **↑** or **↓** repeatedly to select a setting, then press **ENTER**.

The setting is selected and the setup is completed.

Example: “4:3 PAN SCAN”

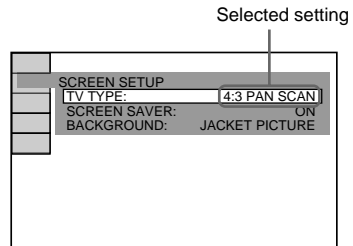

To turn off the Setup Display
Press DVD SETUP repeatedly until the Setup Display disappears.

Tip

If you select “RESET” in step 3, you can reset all of the “SETUP” settings on pages 29 – 42 (except for “PARENTAL CONTROL”) to the default settings.

Setting the display or sound track language

— LANGUAGE SETUP

“LANGUAGE SETUP” allows you to set various languages for the on-screen display or sound track.

Select “LANGUAGE SETUP” in the Setup Display.

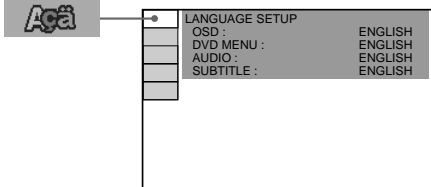

■ OSD (on-screen display)

Switches the display language on the screen. Select the language from the displayed list.

■ DVD MENU (DVD only)

Select the language for the DVD menu.*

■ AUDIO (DVD only)

Switches the language of the sound track. Select the language from the displayed list.*

■ SUBTITLE (DVD only)

Switches the language of the subtitle. Select the language from the displayed list.*

* If you select “OTHERS →” in “DVD MENU”, “AUDIO” or “SUBTITLE”, select and enter the language code from the list using the number buttons (see page 77). After you selected, the language code (4 digits) is displayed the next time you select “OTHERS →”.

Note

When you select a language that is not recorded on the DVD, one of the recorded languages will be automatically selected (except for “OSD”).

Settings for the display

— SCREEN SETUP

Select settings according to the connected TV.

Select “SCREEN SETUP” in the Setup Display.

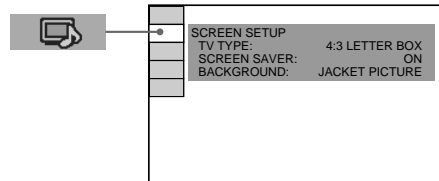

■ TV TYPE (DVD only)

Select the aspect ratio of the connected TV.

- **4:3 LETTER BOX:** Select this when you connect a 4:3 screen TV. This setting displays a wide picture with bands displayed on the upper and lower portions of the screen.



- **4:3 PAN SCAN:** Select this when you connect a 4:3 screen TV. This setting displays the wide picture on the entire screen and cuts off the portions that do not fit.

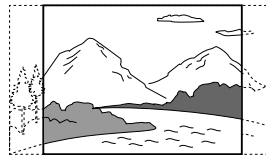

continued

Settings for the display (continued)

- **16:9:** Select this when you connect a wide-screen TV or a TV with a wide mode function.

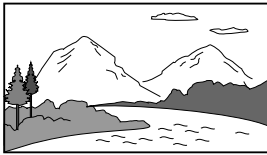

Note

Depending on the DVD, “4:3 LETTER BOX” may be selected automatically instead of “4:3 PAN SCAN” or vice versa.

■ SCREEN SAVER

Turn on and off the screen saver. If you turn on the screen saver, the screen saver image appears when you leave the player in pause or stop mode for 15 minutes or when you play a CD for more than 15 minutes. The screen saver will help prevent your display device from becoming damaged (ghosting). Press any DVD-related button.

- **ON:** Turns on the screen saver.
- **OFF:** Turns off the screen saver.

■ BACKGROUND

Select the background color or picture on the TV screen when the playback is stopped or while playing a CD.

- **JACKET PICTURE:** The jacket picture (still picture) appears in the background, but only when the jacket picture is already recorded on the disc (CD-EXTRA, etc). If the disc does not contain a jacket picture, the “GRAPHICS” picture appears.
- **GRAPHICS:** The preset picture stored in the system appears in the background.
- **BLUE:** The background color is blue.
- **BLACK:** The background color is black.

Custom settings

— CUSTOM SETUP

Select “CUSTOM SETUP” in the Setup Display.

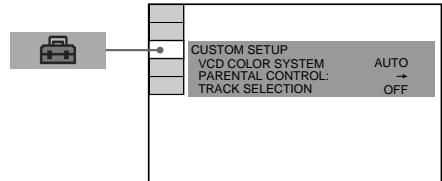

■ VCD COLOR SYSTEM

Select the color system when you play a VIDEO CD.

- **AUTO:** Outputs the video signal in the system of the disc, either PAL or NTSC. If your TV uses a DUAL system, select AUTO.
- **PAL:** Changes the video signal of an NTSC disc and outputs it in the PAL system.
- **NTSC:** Changes the video signal of a PAL disc and outputs it in the NTSC system.

Notes

- You cannot change the color system of the disc itself.
- You can change the color system of this unit according to the connected TV (see page 13).

■ PARENTAL CONTROL→ (DVD only)

Set a password and playback limitation level for DVDs with playback limitation for children. For details, see “Limiting playback by children (Parental Control)” on page 40.

■ TRACK SELECTION (DVD only)

Gives the priority to the sound track which contains the highest number of channels when you play a DVD on which multiple audio formats (PCM, DTS, MPEG audio, or Dolby Digital format) are recorded.

- **OFF**: No priority given.
- **AUTO**: Priority given.

Notes

- When you set to “AUTO”, the language setting may change. The “TRACK SELECTION” setting has higher priority than the “AUDIO” setting in “LANGUAGE SETUP” (see page 29).
- If PCM, DTS, MPEG audio, and Dolby Digital sound tracks have the same number of channels, the system selects PCM, DTS, MPEG audio, and Dolby Digital sound tracks in this order.
- Depending on the DVD, the audio channel with priority may be predetermined. In this case, you cannot give priority to the PCM, DTS, MPEG audio, or Dolby Digital audio format by selecting “AUTO”.

Speaker settings

— SPEAKER SETUP

To obtain the best possible surround sound, set the size of the speakers you have connected and their distance from your listening position.

Then use the test tone to adjust the volume and the balance of the speakers to the same level.

Select “SPEAKER SETUP” in the Setup Display.

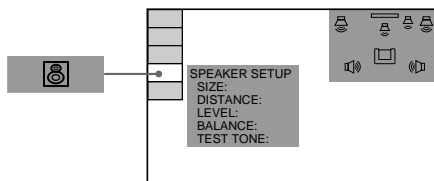

To return to the default setting
Select the item, then press CLEAR on the remote.

■ SIZE (except for MHC-RV600D)

When you do not connect center, rear speakers or sub woofer, or you move the rear speakers, set the parameters for CENTER, REAR and SUBWOOFER. Since the front speaker setting is fixed, you cannot change it.

FRONT

- **YES**

CENTER

- **YES**: Normally select this position.
- **NONE**: Select this when a center speaker is not used.

continued

Speaker settings (continued)

REAR

- YES: Normally select this position.
- NONE: Select this when rear speakers are not used.

SUBWOOFER

- YES

Notes

- When you select an item, the sound cuts off for a moment.
- Depending on the settings of other speakers, the sub woofer may output excessive sound.
- When you play a DVD that does not have sub woofer output recorded, note that no sound is produced from the sub woofer, even if "SUBWOOFER" is set to "YES".

■ DISTANCE (except for MHC-RV600D)

The default distance setting for the speakers in relation to the listening position is shown below.

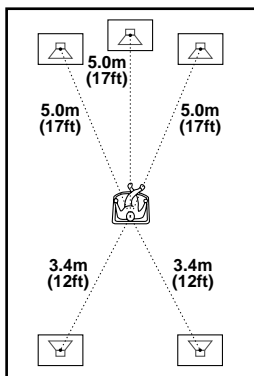

Be sure to change the value in the Setup Display when you move the speakers.

- FRONT: Front speaker distance from the listening position can be set in 0.2 meter (1 foot) steps from 0.9 to 15.0 meters (3 to 50 feet).
- CENTER: Center speaker distance can be moved up to 1.5 meters (5 feet) closer to the listening position, from the front speakers in 0.2 meter (1 foot) steps.
- REAR: Rear speaker distance can be moved up to 4.5 meters (15 feet) closer to the listening position, from the front speakers in 0.2 meter (1 foot) steps.

Notes

- When you select an item, the sound cuts off for a moment.
- If each of the front or rear speakers is not placed at an equal distance from your listening position, set the distance of the closest speaker.
- Do not place the rear speakers farther away from your listening position than the front speakers.

■ LEVEL (except for MHC-RV600D)

You can vary the level of each speaker as follows. Be sure to set "TEST TONE" to "ON" for easy adjustment.

The default settings are in parentheses.

- CENTER (0 dB): Adjust the level of the center speaker (-6 dB to +6 dB, 1 dB steps).
- REAR (0 dB): Adjust the level of the rear speakers (-6 dB to +6 dB, 1 dB steps).
- SUBWOOFER*1 (0 dB): Adjust the level of the sub woofer (-10 dB to +10 dB, 1 dB steps).

*1 MHC-GX90D and RV800D only

■ BALANCE

You can vary the balance of the left and right speakers as follows. Be sure to set “TEST TONE” to “ON” for easy adjustment.

The default settings are in parentheses.

- **FRONT** (0 step): Adjust the balance between the front left and right speakers (6 steps left or right).
- **REAR** (0 step)*: Adjust the balance between the rear left and right speakers (6 steps left or right).

* except for MHC-RV600D

■ TEST TONE (except for MHC-RV600D)

The speakers will emit a test tone to adjust “BALANCE” and “LEVEL”.

- **OFF**: The test tone is not emitted from the speakers.
- **ON**: The test tone is emitted from each speaker in sequence while adjusting balance or level. When you select one of the “SPEAKER SETUP” items, the test tone is emitted from both left and right speakers simultaneously.

Note

When you adjust the level of the sub woofer, set T.TONE to “OFF”.

To adjust the volume of all the speakers at once

Turn VOLUME (or press VOL +/- on the remote).

Adjusting the speaker volume and level

Use the remote for the operation.

For MHC-GX90D/RV800D/RV900D

- 1 Press **DVD SETUP** in stop mode.
- 2 Press **↑** or **↓** repeatedly to select “**SPEAKER SETUP**”, then press **ENTER**.
- 3 Press **↑** or **↓** repeatedly to select “**TEST TONE**”, then press **ENTER**.
- 4 Press **↑** or **↓** repeatedly to select “**ON**”, then press **ENTER**.
You will hear the test tone from each speaker in sequence.
- 5 From your listening position, adjust the value of “**SIZE**”, “**DISTANCE**”, “**BALANCE**” and “**LEVEL**” using **↑/↓/←/→**.
The test tone is emitted from both left and right speakers simultaneously.
- 6 Press **ENTER** when you finish adjusting.
- 7 Press **↑** or **↓** repeatedly to select “**TEST TONE**”, then press **ENTER**.
- 8 Press **↑** or **↓** repeatedly to select “**OFF**”, then press **ENTER**.

continued

Speaker settings (continued)

For MHC-RV600D

- 1 Press **DVD SETUP** in stop mode.
- 2 Press **↑** or **↓** repeatedly to select **“SPEAKER SETUP”**, then press **ENTER**.
- 3 Adjust the value of **“BALANCE”** using **↑/↓/←/→**.
- 4 Press **ENTER** when you finish adjusting.

Note

When you adjust the speaker settings, the sound cuts off for a moment.

Sound adjustment

Changing the sound

If a DVD is recorded with multilingual tracks, you can select the language you want while playing the DVD. If the DVD is recorded in multiple audio formats (PCM, Dolby Digital, MPEG audio, or DTS), you can select the audio format you want while playing the DVD.

With stereo CDs or VIDEO CDs, you can select the sound from the right or left channel and listen to the sound of the selected channel through both the right and left speakers. (In this case, the sound loses its stereo effect.) For example, when playing a disc containing a song with the vocals on the right channel and the instruments on the left channel, you can select the left channel and hear only the instruments from both speakers.

You cannot change the sound of MP3 audio tracks.

- 1 Press **DVD DISPLAY** during play.
The Control Menu appears.
- 2 Press **▲** or **▼** (or **↑** or **↓** on the remote) repeatedly to select **“AUDIO”**, then press **ENTER**.

3 Press **▲** or **▼** (or **↑** or **↓** on the remote) repeatedly to select the audio signal you want.

■ When playing a DVD

Depending on the DVD, the choice of the language varies. When 4 digits are displayed, they represent the language code (see “Language code list” on page 77). When the same language is displayed two or more times, the DVD is recorded in multiple audio formats.

■ When playing a VIDEO CD or CD

- STEREO: The standard stereo sound.
- 1/L: The sound of the left channel (monaural).
- 2/R: The sound of the right channel (monaural).

4 Press **ENTER**.

To turn off the Control Menu

Press **DVD DISPLAY** repeatedly until the Control Menu disappears.

Tip

You can select “AUDIO” directly by pressing **AUDIO** on the remote. Each time you press the button, the item changes.

Notes

- For discs not in multiple audio format, you cannot change the sound.
- During DVD playback, the sound may change automatically.

Displaying the audio information of the disc

(DVD only)

When you select “AUDIO”, the channels being played are displayed on the screen.

For example, in Dolby Digital format, multiple signals ranging from monaural to 5.1 channel signals can be recorded on a DVD. Depending on the DVD, the number of the recorded channels may differ.

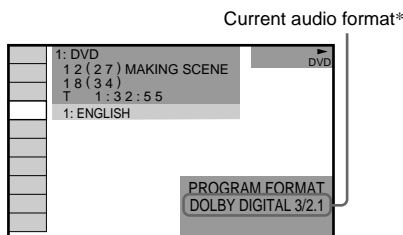

* “PCM”, “MPEG”, “DTS”, or “DOLBY DIGITAL” is displayed.

For “DOLBY DIGITAL”, the channels in the playing track are displayed numerically as follows:

For Dolby Digital 5.1 ch:

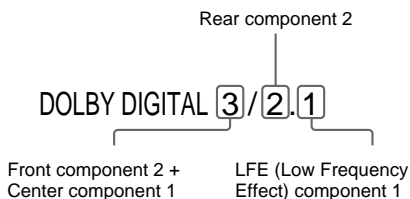

continued

Changing the sound (continued)

The display examples are as follows:

- PCM (stereo)

```
PROGRAM FORMAT
PCM 48kHz 24bit
```

- Dolby Surround

```
PROGRAM FORMAT
DOLBY DIGITAL 2/0
DOLBY SURROUND
```

- Dolby Digital 5.1ch

```
PROGRAM FORMAT
DOLBY DIGITAL 3/2.1
```

- DTS

```
PROGRAM FORMAT
DTS 3/2.1
```

Searching for a title/ chapter/track/index

You can search a DVD disc by title or chapter, and you can search a VIDEO CD by track or index and a CD or MP3 by track. As titles and tracks are assigned unique numbers on the disc, you can select the desired one by entering its number. Or, you can search for a scene using the time code (Time Search).

1 Press DVD.

2 Press DVD DISPLAY.

The Control Menu appears.

3 Press ▲ or ▼ (or ↑ or ↓ on the remote) repeatedly to select the search method.

■ When playing a DVD

“TITLE” or “CHAPTER”

Select “TIME” for Time Search.

■ When playing a VIDEO CD

“TRACK” or “INDEX”

Select “TIME” for Time Search.

■ When playing a CD

“TRACK”

Select “TIME” for Time Search.

■ When playing an MP3

“ALBUM” or “TRACK”

Select “TIME” for Time Search.

4 Press ENTER.

“** (**)” changes to “- (**)”.

The number in parentheses indicates the total number of title, chapters, tracks, indexes, or albums.

- 5 Press **▲** or **▼** (or **↑** or **↓** on the remote) repeatedly, or press the number buttons to select the title, chapter, track, index or album number you want to search.

If you make a mistake

Press **CLEAR** on the remote to cancel the number, then select another number.

- 6 Press **ENTER**.

Playback starts from the selected number.

To search for a scene using the time code (Time Search)

- 1 In step 3, select **“TIME”**.

“T **:**:**” (playing time of the current title) is displayed.

- 2 Press **ENTER**.

“T **:**:**” changes to “- -: - -: - -”.

- 3 Input the time code using the number buttons, then press **ENTER**.

For example, to find the scene at 2 hours, 10 minutes, and 20 seconds after the beginning, enter “2:10:20”.

To turn off the Control Menu

Press **DVD DISPLAY** repeatedly until the Control Menu disappears.

Notes

- The displayed number of title, chapters, or tracks is the same number of title, chapters, or tracks recorded on the disc.
- You cannot perform Time Search during PBC playback of VIDEO CDs (see page 27).

Changing the angles

(DVD only)

If various angles (multi-angles) for a scene are recorded on the DVD, “ANGLE” appears in the display. This means that you can change the viewing angle. For example, while playing a scene of a train in motion, you can display the view from either the front of the train, the left window of the train or from the right window without having the train’s movement interrupted.

Use the remote for the operation.

- 1 Press **DVD DISPLAY** during play.

The Control Menu appears.

- 2 Press **↑** or **↓** repeatedly to select **“ANGLE”**.

The angle number appears. The number in parentheses indicates the total number of angles.

- 3 Press **ENTER**.

The angle number changes to “-”.

- 4 Select the angle you want using the number buttons or **↑/↓**, then press **ENTER**.

The angle is changed to the selected angle.

To turn off the Control Menu

Press **DVD DISPLAY** repeatedly until the Control Menu disappears.

Tip

You can select the angle by pressing **ANGLE**. Each time you press the button, the angle changes.

Note

Depending on the DVD, you may not be able to change the angles even if multi-angles are recorded on the DVD.

Displaying the subtitles

(DVD only)

With DVDs on which multilingual subtitles are recorded, you can change the subtitle language while playing a DVD, or turn the subtitles on or off whenever you want. For example, you can select the language you want to master and turn the subtitles on for better understanding.

Use the remote for the operation.

- 1 **Press DVD DISPLAY during play.**
The Control Menu appears.
- 2 **Press \uparrow or \downarrow repeatedly to select "SUBTITLE", then press ENTER.**
The options for "SUBTITLE" appear.
- 3 **Press \uparrow or \downarrow repeatedly to select the language you want, then press ENTER.**
The subtitles are displayed in the selected language.

To cancel the SUBTITLE setting
Select "OFF" in step 3.

To turn off the Control Menu
Press DVD DISPLAY repeatedly until the Control Menu disappears.

Tip

You can select the subtitle by pressing SUBTITLE. Each time you press the button, the language changes.

Notes

- When 4 digits are displayed in step 3, they indicate the language code. Refer to the language code list on page 77 to see the language code represents.
- Depending on the DVD, you may not be able to change the subtitles even if multilingual subtitles are recorded on the DVD.

Locking discs

— CUSTOM PARENTAL CONTROL/ PARENTAL CONTROL

You can set two kinds of playback restrictions for the disc.

- **Custom Parental Control**
You can set the playback restrictions so that the system will not play inappropriate discs. You can set the same Custom Parental Control password for up to 25 discs. When you set the twenty-sixth disc, the playback restriction for the first disc is canceled.
- **Parental Control**
You can limit the playback of some DVDs according to a predetermined level such as the age of the users. The limited scene is not played, or replaced by a different scene.

The same password is used for both Custom Parental Control and Parental Control.

Use the remote for the operation.

Custom Parental Control

- 1 **Insert the disc you want to lock.**
If the disc is playing, press \blacksquare to stop playback.
- 2 **Press DVD DISPLAY in stop mode.**
The Control Menu appears.
- 3 **Press \uparrow or \downarrow repeatedly to select "CUSTOM PARENTAL CONTROL", then press ENTER.**
The "CUSTOM PARENTAL CONTROL" display appears.

4 Press **↑** or **↓** repeatedly to select "ON →" then press ENTER.

■ If you have not entered a password

The display for registering a new password appears.

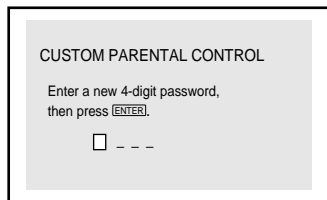

Enter a 4-digit password using the number buttons, then press ENTER.

The display for confirming the password appears.

■ When you have already registered a password

Press **↑** or **↓** repeatedly to select "PASSWORD →", then press ENTER.

The display for entering the password appears.

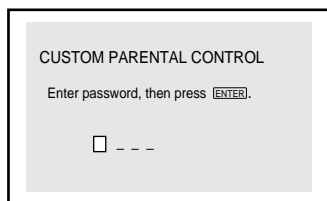

5 Enter or re-enter your 4-digit password using the number buttons, then press ENTER.

"Custom parental control is set." appears and the screen returns to the Control Menu.

If you make a mistake entering your password

Press **←** before you press ENTER and input the correct number.

If you make a mistake

Press RETURN **↵**, then start from step 3 again.

To turn off the Control Menu

Press RETURN **↵**, then press DVD DISPLAY repeatedly until the Control Menu disappears.

To turn off the Custom Parental Control function

1 In step 4, select "OFF →", then press ENTER.

2 Enter your 4-digit password using the number buttons, then press ENTER.

To change the password

1 In step 4, press **↑** or **↓** repeatedly to select "PASSWORD →", then press ENTER.

The display for entering the password appears.

2 Enter your 4-digit password using the number buttons, then press ENTER.

3 Enter a new 4-digit password using the number buttons, then press ENTER.

4 To confirm your password, re-enter it using the number buttons, then press ENTER.

continued

Locking discs (continued)

Playing the disc for which Custom Parental Control is set

1 Insert the disc for which Custom Parental Control is set.

The “CUSTOM PARENTAL CONTROL” display appears.

2 Enter your 4-digit password using the number buttons, then press ENTER.

The system is ready for playback.

Tip

If you forget your password, enter the 6-digit number “199703” using the number buttons when the “CUSTOM PARENTAL CONTROL” display asks you for your password, then press ENTER. The display will ask you to enter a new 4-digit password.

Limiting playback by children (Parental Control)

(DVD only)

1 Press DVD SETUP in stop mode.

The Control Menu appears.

2 Press \uparrow or \downarrow repeatedly to select “CUSTOM SETUP”, then press ENTER.

The “CUSTOM SETUP” display appears.

3 Press \uparrow or \downarrow repeatedly to select “PARENTAL CONTROL” \rightarrow then press ENTER.

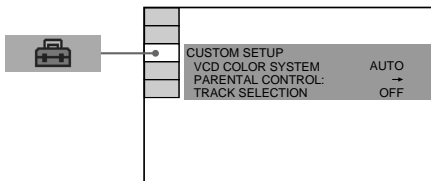

■ If you have not entered a password

The display for registering a new password appears.

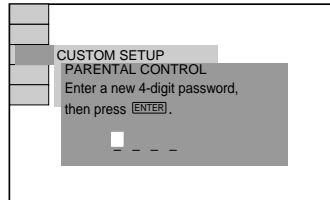

Enter a 4-digit password using the number buttons, then press ENTER.

The display for confirming the password appears.

■ When you have already registered a password

The display for entering the password appears.

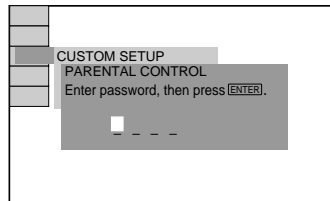

4 Enter or re-enter your 4-digit password using the number buttons, then press ENTER.

The display for setting the playback limitation level and changing the password appears.

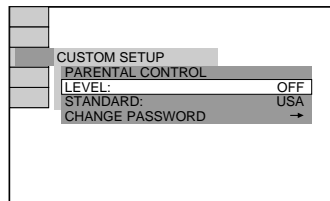

5 Press \uparrow or \downarrow repeatedly to select “STANDARD”, then press ENTER.

The options for “STANDARD” appear.

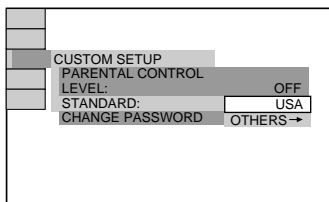

6 Press \uparrow or \downarrow repeatedly to select a geographic area as the playback limitation level, then press ENTER.

The area is selected.

When you select “OTHERS \rightarrow ”, select and enter the standard code in the table on page 42 using the number buttons.

7 Press \uparrow or \downarrow repeatedly to select “LEVEL”, then press ENTER.

The options for “LEVEL” appear.

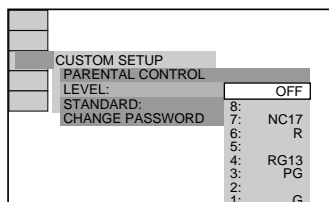

8 Press \uparrow or \downarrow repeatedly to select the level you want, then press ENTER.

The Parental Control setting is completed.

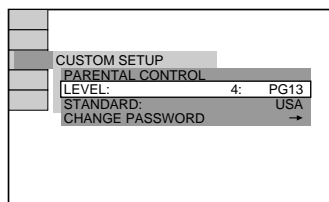

The lower the value, the more strict the limitation.

If you make a mistake

Press RETURN \rightarrow to go back to the previous screen.

To turn off the Control Menu

Press DVD DISPLAY repeatedly until the Control Menu disappears.

To turn off the Parental Control function and play the DVD after entering your password
Set “LEVEL” to “OFF” in step 8.

To change the password

1 In step 5, press \downarrow to select “CHANGE PASSWORD \rightarrow ”, then press ENTER.
The display for entering the password appears.

2 Follow step 3 to enter a new password.

Playing a disc for which
Parental Control is set

1 Insert the disc and press $\blacktriangleleft\blacktriangleright$.

The “PARENTAL CONTROL” display appears.

2 Enter your 4-digit password using the number buttons, then press ENTER.

Playback starts.

continued

Locking discs (continued)

Tip

If you forget your password, remove the disc and repeat steps 1 to 5 of “Limiting playback by children”. When you are asked to enter your password, enter “199703” using the number buttons, then press ENTER. The display will ask you to enter a new 4-digit password. After you enter a new 4-digit password in step 3, replace the disc in the system and press ◀▶. When the “PARENTAL CONTROL” display appears, enter your new password.

Notes

- When you play DVDs which do not have the Parental Control function, playback cannot be limited on this system.
- Depending on the DVD, you may be asked to change the parental control level while playing the disc. In this case, enter your password, then change the level. If the Resume Play mode is canceled, the level returns to the original level.

Area code

Standard	Code number
Argentina	2044
Australia	2047
Austria	2046
Belgium	2057
Brazil	2070
Canada	2079
Chile	2090
China	2092
Denmark	2115
Finland	2165
France	2174
Germany	2109
Hong Kong	2219
India	2248
Indonesia	2238
Italy	2254
Japan	2276
Korea	2304
Malaysia	2363
Mexico	2362
Netherlands	2376
New Zealand	2390
Norway	2379
Pakistan	2427
Philippines	2424
Portugal	2436
Russia	2489
Singapore	2501
Spain	2149
Sweden	2499
Switzerland	2086
Taiwan	2543
Thailand	2528
United Kingdom	2184

Presetting radio stations

You can preset up to 20 FM stations and 10 AM stations. You can then tune in any of those stations simply by selecting the corresponding preset number.

There are two ways to store the station presets.

To	Method
Automatically tune in all of the stations that can be received in your area and then store them manually	Automatic Tuning Preset
Manually tune in and store the radio frequency of your favorite stations	Manual Tuning Preset

Setting presets through automatic tuning

- 1 Press **TUNER/BAND** repeatedly to select "FM" or "AM".
- 2 Press and hold **-** or **+** (or **TUNING -** or **+** on the remote) until the frequency indication starts to change, then release it.

Scanning stops automatically when the system tunes in a station. "TUNED" and "STEREO" (for an FM stereo program) appear.

If "TUNED" does not appear and the scanning does not stop

Set the frequency of the desired radio station as described in steps 2 through 6 of "Setting presets through manual tuning".

3 Press **TUNER MEMORY**.

A preset number appears in the display. The stations are stored from preset number 1.

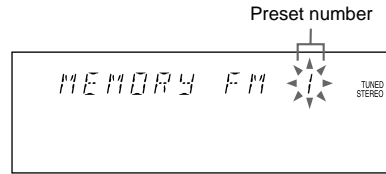

- 4 Press **◀◀** or **▶▶** (or **PRESET -** or **+** on the remote) repeatedly to select the desired preset number.
- 5 Press **ENTER**.
- 6 Repeat steps 1 to 5 to store other stations.

Setting presets through manual tuning

- 1 Press **TUNER/BAND** repeatedly to select "FM" or "AM".
- 2 Press **-** or **+** (or **TUNING -** or **+** on the remote) repeatedly to tune in the desired station.
- 3 Press **TUNER MEMORY**.
A preset number appears in the display. The stations are stored from preset number 1.
- 4 Press **◀◀** or **▶▶** (or **PRESET -** or **+** on the remote) repeatedly to select the desired preset number.
- 5 Press **ENTER**.
- 6 Repeat steps 1 to 5 to store other stations.

continued

Presetting radio stations (continued)

Other Operations

To	Do this
Tune in a station with a weak signal	Follow the procedure described in “Setting presets through manual tuning”.
Set another station to an existing preset number	Start over from step 1. After step 3, press I◀◀ or ▶▶I (or PRESET – or + on the remote) repeatedly to select the preset number you want to store the other station.

To change the AM tuning interval (except for the European, Middle Eastern and Philippine models) The AM tuning interval is factory-set to 9 kHz (10 kHz in some areas). To change the AM tuning interval, tune in any AM station first, then turn off the system. While holding down ENTER, turn the system back on. When you change the interval, all the AM preset stations are erased. To reset the interval, repeat the same procedure.

Note

You cannot change the AM tuning interval in the Power Saving Mode.

Tips

- The preset stations are retained for half a day even if you disconnect the power cord or if a power failure occurs.
- To improve broadcast reception, reorient or move the supplied antenna near a window or outdoors.

Listening to the radio

You can listen to a radio station either by selecting a preset station, or by manually tuning in the station.

Listening to a preset station

— Preset Tuning

Preset radio stations in the tuner’s memory first (see “Presetting radio stations” on page 43).

- 1 Press **TUNER/BAND** repeatedly to select “FM” or “AM”.
- 2 Press **I◀◀** or **▶▶I** (or PRESET – or + on the remote) repeatedly to select the desired preset station.

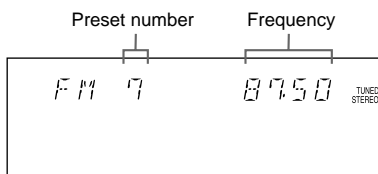

Listening to non-preset radio station

— *Manual Tuning*

- 1 Press **TUNER/BAND** repeatedly to select “FM” or “AM”.
- 2 Press **–** or **+** (or **TUNING –** or **+** on the remote) repeatedly to tune in the desired station.

Tips

- When an FM stereo program has static noise, press **FM MODE** repeatedly until “MONO” appears. There will be no stereo effect, but the reception will improve.
- To improve broadcast reception, adjust the supplied antennas.
- Press and hold **–** or **+** (or **TUNING –** or **+** on the remote). The frequency indication changes and scanning stops when the system tunes in a station (Automatic Tuning).
- To record from the radio, see “Recording from a disc/tape/radio manually” on page 48 or “Timer-recording radio programs” on page 50.

Notes

- When the **TUNER** function is selected, the OSD does not appear on the screen.
- When “DVD” is selected as the current function and **TUNER/BAND** is pressed to select “TUNER”, it may take some time to switch the function.

Using the Radio Data System (RDS)

(European model only)

What is the Radio Data System?

Radio Data System (RDS) is a broadcasting service that allows radio stations to send additional information along with the regular program signal. This tuner offers convenient RDS features like station name display and location of stations by program type. RDS is available only on FM stations.*

Note

RDS may not work properly if the station you tuned in is not transmitting the RDS signal properly or if the signal is weak.

* Not all FM stations provide RDS service, nor do they provide the same types of services. If you are not familiar with the RDS system, check with your local radio stations for details on RDS services in your area.

Receiving RDS broadcasts

Simply select a station from the FM band.

When you tune in a station that provides RDS services, the station name appears in the display.

To check the RDS information

Press DISPLAY.

Each time you press the button, the display changes cyclically as follows:

Station name* → Frequency → Program type* → Clock display → Effect status

* If the RDS broadcast is not properly received, the station name and program type may not appear in the display.

continued

Using the Radio Data System (RDS) (continued)

Locating a station by program type (PTY)

You can locate a station you want by selecting a program type. The tuner tunes in the type of programs currently being broadcast from the RDS stations stored in the tuner's preset memory.

The types of programs include NEWS, AFFAIRS (current news), INFO, SPORT, EDUCATE (education programs), DRAMA, CULTURE, SCIENCE, VARIED (interviews, games and comedy), POP M, ROCK M, EASY M, LIGHT M, CLASSICS, OTHER M, WEATHER, FINANCE, CHILDREN, SOCIAL, RELIGION, PHONE IN, TRAVEL, LEISURE, JAZZ, COUNTRY (country music), NATION M (nation's popular music), OLDIES, FOLK M, DOCUMENT (investigative features), TEST (test signal for emergency broadcast), ALARM (emergency broadcast) and NONE (any programs not defined above).

- 1 Press PTY while listening to the radio.**
- 2 Press ◀◀ or ▶▶ repeatedly to select the program type you want.**
- 3 Press ENTER.**

“PTY SEARCH” and the selected program type appear alternately in the display.

When the tuner receives a program, the preset station name flashes.
- 4 Press ◀◀ or ▶▶ repeatedly to continue searching for the station name you want.**
- 5 Press ENTER while the preset station name you want is flashing.**

To cancel the PTY search
Press PTY again.

Note

“NO PTY” appears when the program type you selected is not currently being broadcast.

Loading a tape

- 1 Press **TAPE A/B** repeatedly to select deck A or B.
- 2 Press **▲ PUSH**.
- 3 Insert a tape in deck A or B with the side you want to play/record facing forward.

With the side you want to play/record facing forward.

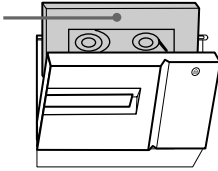

Playing a tape

You can use TYPE I (normal) tape.

- 1 Load a tape.
- 2 Press **DIRECTION** repeatedly to select **▶▶** to play one side. Select **◀▶*** to play both sides.

To play both decks in succession, select “RELAY” (Relay Play)*².

- 3 Press **◀▶** (or **◀▶** on the remote). Press **◀▶** (or **◀▶** on the remote) again to play the reverse side. Playback starts.

Tape presence indicator

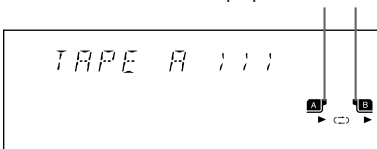

- *¹ The deck stops automatically after repeating the sequence five times.
- *² Relay Play always follows this cyclic sequence up to five times, then stops:
 Deck A (front side) → Deck A (reverse side)
 → Deck B (front side) → Deck B (reverse side)

Other Operations

To	Do this
Stop play	Press ■ .
Pause	Press . Press again to resume play.
Fast-forward or rewind	Press ▶▶ or ◀◀ .
Remove the cassette	Press ▲ PUSH .

Searching for the beginning of the current or the next track (AMS)*

To go forward

Press **▶▶** during playback when **▶** lights in the display.

“TAPE A (or TAPE B) >>> +1” appears.

Press **◀◀** during playback when **◀** lights in the display.

“TAPE A (or TAPE B) <<< +1” appears.

To go back

Press **◀◀** during playback when **▶** lights in the display.

“TAPE A (or TAPE B) <<< -1” appears.

Press **▶▶** during playback when **◀** lights in the display.

“TAPE A (or TAPE B) >>> -1” appears.

* AMS (Automatic Music Sensor)

Tip

When a tape is inserted, corresponding forward/reverse indicators light.

Note

The AMS function may not operate correctly under the following circumstances:

- When the unrecorded space between songs is less than 4 seconds long.
- When the system is placed near a television.

Recording to a tape

— CD Synchro Recording/Recording Manually/Program Edit

You can record from a disc (DVD, VIDEO CD, CD, MP3), tape, radio or other connected component. You can use TYPE I (normal) tapes. The recording level is adjusted automatically.

Steps	Recording from a disc (CD Synchro Recording)	Recording from a disc/tape/radio manually
1	Load a recordable tape into deck B.	
2	Press DVD.	Press a function button for the recording source.
3	Load the disc you want to record.	Load the disc or tape (or other audio source), or tune in the station you want to record.
4	Press CD SYNC.	Press REC PAUSE/START.
	Deck B stands by for recording. “REC” flashes.	
5	Press DIRECTION repeatedly to select \rightleftarrows to record on one side. Select \leftrightarrow (or RELAY) to record on both sides.	
6	Press REC PAUSE/START. Recording starts.	Press REC PAUSE/START, and then start playing the recording source.

To stop recording

Press ■.

Tips

- If you want to record from the reverse side, press TAPE A/B to select deck B after step 1. Press \triangleleft (or \blacktriangleleft on the remote) to start playback of the reverse side, then press ■ to start recording. The TAPE B reverse indicator lights up.
- When you record on both sides, be sure to start from the front side. If you start from the reverse side, recording stops at the end of the reverse side.
- For recording from the radio:
If noise is heard while recording from the radio, move the respective antenna to reduce the noise.

Notes

- You cannot listen to other sources while recording.
- CD Synchro Recording is not available with DVDs.

Recording a VIDEO CD/CD/MP3 by specifying the track order

— **Program Edit**

When programing, make sure the playing time for each side do not exceed the length of one side of the tape.

1 Load a disc and load a recordable tape into deck B.

2 Press DVD.

3 In stop mode, press **PLAY MODE** repeatedly until “PGM” appears in the display.

The Program Display appears on the screen.

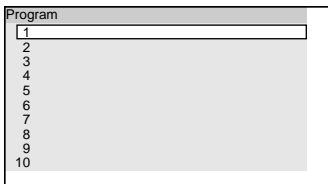

4 Press **▶** (or **➡** on the remote), then press **▲** or **▼** (or **⬆** or **⬇** on the remote) repeatedly to select the disc.

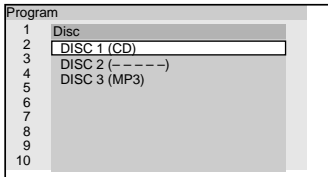

5 Press **▶** (or **➡** on the remote).

The cursor moves to the track (in this case, “DISC 1”).

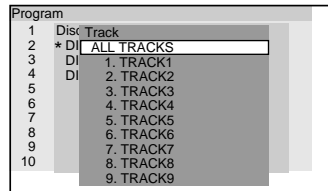

* “?” appears when the system has not loaded the disc information in the memory.

6 Select the track you want to program.

For example, select track “10”.

Press **▲/▼** (or **⬆/⬇** on the remote) or the number buttons to select “10”, then press **ENTER**.

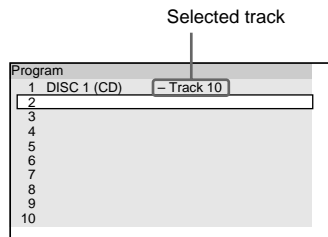

7 To program additional steps, repeat steps 3 to 5.

continued

Tape

Recording to a tape (continued)

8 Press CD SYNC.

Deck B stands by to record in the direction of the indicator on  (the right indicator lights to record on the front side and the left indicator lights to record on the reverse side).

9 Press DIRECTION repeatedly to select to record on one side.

Select  (or RELAY) to record on both sides.

10 Press REC PAUSE/START.

Recording starts.

To cancel Program Edit

Press PLAY MODE repeatedly until “1 DISC” or “ALL DISCS” appears in the display.

Timer-recording radio programs

You can record a preset radio station from a specified time.

To timer-record, you must first preset the radio station (see “Presetting radio stations” on page 43) and set the clock (see “Setting the clock” on page 16).

1 Tune in the preset radio station (see “Listening to the radio” on page 44).







2 Press CLOCK/TIMER SET on the remote.

“DAILY 1 SET” appears.





3 Press or (or or on the remote) repeatedly to select “REC SET”, then press ENTER.

“ON” appears and the hour indication flashes.

4 Set the time to start recording.

Press  or  (or  or  on the remote) repeatedly to set the hour, then press  (or  on the remote).

The minute indication starts flashing.

Press  or  (or  or  on the remote) repeatedly to set the minute, then press ENTER.

5 Repeat step 4 to set the time to stop recording.

The start time appears, followed by the stop time, the preset radio station to be recorded (e.g., “TUNER FM 5”), then the original display appears.

6 Load a recordable tape into deck B.

7 Press to turn off the system.

When the recording starts, the volume level is set to the minimum.

Other Operations

To	Do this
Check the setting	Press CLOCK/TIMER SELECT on the remote and press ▲ or ▼ (or ↑ or ↓ on the remote) repeatedly to select "REC SELECT". Then, press ENTER.
Change the setting	Start over from step 1.
Cancel the timer	Press CLOCK/TIMER SELECT on the remote and press ▲ or ▼ (or ↑ or ↓ on the remote) repeatedly to select "TIMER OFF", then press ENTER.

Notes

- If the system is on at the preset time, the recording will not be made.
- When you use the Sleep Timer, Daily Timer and Timer recording will not turn on the system until the Sleep Timer turns it off.
- You cannot activate Daily Timer and Timer-recording at the same time.

Adjusting the sound

You can reinforce the bass and create a more powerful sound.

The GROOVE setting is ideal for music sources, and the V-GROOVE setting is ideal for video sources (movies, DVDs and VCDs).

Press GROOVE.

Each time you press the button, the display changes cyclically as follows:

GROOVE ON* → V-GROOVE ON*
→ GROOVE OFF (off)

* The volume switches to power mode, the equalizer curve changes, and a "GROOVE" or "V GROOVE" lights up.

Selecting the sound effect

Selecting the effect from the music menu

Press MUSIC EQ, MOVIE EQ or GAME EQ repeatedly to select the preset you desire.

The preset name appears in the display. See the chart "Sound effect options".

To cancel the effect

Press EFFECT ON/OFF repeatedly until "EFFECT OFF" appears in the display.

continued

Selecting the sound effect (continued)

Sound effect options

“SURR” appears if you select an effect with surround effects.

MUSIC EQ

Effect

ROCK	Standard music sources
POP	
JAZZ	
DANCE	
SOUL	
ORIENTAL	

MOVIE EQ

Effect

ACTION	Soundtracks and special listening situations
DRAMA	
MUSICAL	

GAME EQ

Effect

ADVENTURE	PlayStation 1, 2 and other video game music sources
ARCADE	
RACING	

Adjusting the graphic equalizer and storing

You can adjust the sound by raising or lowering the levels of specific frequency ranges, then store up to three personal files (P FILE) in the memory.

Select the audio emphasis you want for your basic sound first.

1 Press P FILE.

The graphic equalizer appears in the display.

- 2 Press ◀ or ▶ (or ◀ or ▶ on the remote) repeatedly to select a frequency band, then press ▲ or ▼ (or ▲ or ▼ on the remote) to adjust the level.

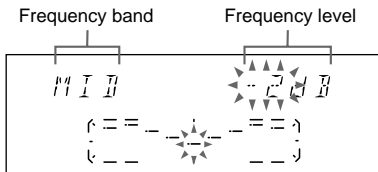

3 Press and hold P FILE.

A personal file number appears in the display.

- 4 Press P FILE repeatedly to select P FILE 1 – 3 where you want to store the equalizer setting.

5 Press ENTER.

“COMPLETE” appears.

This setting is automatically stored as the personal file you selected in step 3.

Other Operations

To	Press
Call up a personal file	P FILE repeatedly to select the desired personal file number.
Cancel a personal file	EFFECT ON/OFF repeatedly until “EFFECT OFF” appears in the display.

Using the sub woofer

(MHC-GX90D and RV800D only)

You can use the sound of the sub woofer to suit the sound source.

Press ON/OFF on the sub woofer.

The indicator lights up while the sub woofer turns on.

Press the button again to turn off the sub woofer.

Tip

You can use VOLUME (or VOL – or + on the remote) to adjust the volume of the sub woofer linked to the front speakers.

Selecting the surround effect

Press SURROUND on the remote.

Each time you press the button, the display changes as follows:

VIRTUAL* → SURR ON → SURR OFF (off)

* “VIRTUAL” appears, but the sound field with virtual speaker effect is only reproduced for a 2ch source DVD.

Note

When you select other sound effects, the surround effect will be canceled.

Turning off the display

— Power Saving Mode

The demonstration display (display window and buttons lighting and flashing even when the system power is off) and the clock display can be turned off to minimize the amount of power consumed during standby (Power Saving Mode).

Press DISPLAY repeatedly while the system is off until the demonstration display or the clock display disappears.

To cancel the Power Saving Mode Press DISPLAY while the system is off. Each time you press the button, the display switches cyclically as follows:

Demonstration display → Clock display* → No display (Power Saving Mode)

* The clock is displayed only if you set the clock.

Tips

- I/⏻ indicator lights up even in the Power Saving Mode.
- The timer continues to operate in Power Saving Mode.

Note

You cannot perform the following operations in Power Saving Mode.

- setting the clock
- changing the AM tuning interval (except for European, Middle Eastern and Philippine models)
- turning on the system by pressing the function buttons
- switching the MD (VIDEO) function
- changing the color system

Viewing information about the disc

You can check the playing time and remaining time of the current track or that of the disc.

When a DVD/CD-TEXT disc or a disc with MP3 is loaded, you can also check the information recorded on the disc, such as the titles.

Checking the remaining time in the front panel display

Press **DISPLAY** repeatedly during Normal Play.

Each time you press the button, the display changes cyclically as follows:

DVD

Elapsed playing time of the current title →
Remaining time of the current title → Elapsed playing time of the current chapter →
Remaining time of the current chapter →
Title* → Clock display (for eight seconds) →
Effect status

* With DVD TEXT discs only (certain characters cannot be displayed). Depending on the disc, DVD text does not appear and "NO TEXT" appears.

CD or VIDEO CD without PBC function

Elapsed playing time of the current track →
Remaining time of the current track → Elapsed playing time of the disc → Remaining time of the disc → Track title (CD-TEXT disc only) →
Clock display (for eight seconds) → Effect status

VIDEO CD with PBC (Ver. 2.0)

Elapsed playing time on the current scene* →
Clock display (for eight seconds) → Effect status

* May not appear with still images.

MP3

Elapsed playing time of the current track →
Remaining time of the current track → Track title → Album name → Clock display (for eight seconds) → Effect status

Notes

- ID3 tag applies only to version 1.
- If the MP3 file you play back has an ID3 tag, the ID3 tag information is displayed as a track title.
- The ID3 tag character codes comply with ASCII and ISO standards. Joliet format discs can only be displayed in ASCII. Incompatible characters will be displayed as " " (space).
- In the following case, elapsed playing time and time of the track remaining may not be displayed accurately.
 - when an MP3 file of VBR (variable bit rate) is played.

Checking the total playing time in the front panel display

Press **DISPLAY** repeatedly in stop mode.

Each time you press the button, the display changes cyclically as follows:

DVD

Total number of titles*¹ → Disc title*² →
Clock display (for eight seconds) → Effect status

VIDEO CDs, CD or MP3

Total number of tracks and the total playing time*1 → Disc title or album name*2 → Clock display (for eight seconds) → Effect status

*1 When the playback is stopped and “RESUME” appears on the display, the point where playback was stopped is displayed.

*2 With DVD/CD-TEXT discs only (certain characters cannot be displayed). Depending on the disc, DVD/CD text does not appear and “NO TEXT” appears.

For MP3 disc, album names may not be displayed depending on the play mode.

Depending on the disc, some information may not appear.

Using the on-screen display

1 Press DVD DISPLAY during play.

The Control Menu appears.

2 Press ▲ or ▼ (or ↑ or ↓ on the remote) repeatedly to select “TIME”, then press ENTER.

3 Press DISPLAY to change the time information.

The display and the kinds of time that you can change depend on the disc you are playing.

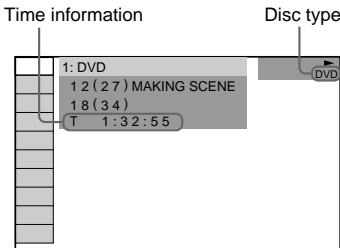

■ When playing a DVD

- T **:**:**
Playing time of the current title
- T-**:**:**
Remaining time of the current title
- C **:**:**
Playing time of the current chapter
- C-**:**:**
Remaining time of the current chapter

■ When playing a VIDEO CD (with PBC functions)

- **:**:**
Playing time of the current scene

■ When playing a VIDEO CD (without PBC functions) or CD

- T **:**:**
Playing time of the current track
- T-**:**:**
Remaining time of the current track
- D **:**:**
Playing time of the current disc
- D-**:**:**
Remaining time of the current disc

■ When playing an MP3

- T **:**:**
Playing time of the current track
- T-**:**:**
Remaining time of the current track

To turn off the Control Menu
Press DVD DISPLAY repeatedly until the Control Menu disappears.

Notes

- Only letters of the alphabet can be displayed.
- Depending on the disc, the system can only display a limited number of characters. Also, depending on the disc, all text characters are not displayed.

Enhancing video game sound

— Game Sync

You need to connect a video game machine (see “Hooking up optional components” on page 61).

Press GAME.

Tips

- In the standby mode, the system automatically turns on.
- The GAME EQ is automatically selected.
- These operations cannot be performed in the Power Saving Mode.

Note

You cannot view game images while a S-video cable is connected. To view game images, disconnect the S-video cable and connect the system and your TV using only the supplied video cable.

Mixing video game sound with other sound source

— Game Mixing

1 Select the desired source sound.

2 Press GAME MIXING.

Each time you press the button, the level of the game sound changes cyclically as follows:

MIXING LOW → MIXING MID →
MIXING HIGH → MIXING OFF (off)

Tips

- The GAME MIXING indicator lights up while Game Mixing is activated.
- Once Game Mixing is activated, it will remain active while the power is on even if the source sound is changed.

Notes

- If you start recording while Game Mixing is activated, Game Mixing is canceled. To record the mixed sound, press GAME MIXING after step 5 of “Recording from a disc/tape/radio manually” on page 48, and then press REC PAUSE/START to start the recording.
- This system outputs the video signal from the GAME INPUT jack while GAME MIXING is activated.
- You cannot view game images while a S-video cable is connected. To view game images, disconnect the S-video cable and connect the system and your TV using only the supplied video cable.

Changing the spectrum analyzer display

- 1 Press **AMP MENU** on the remote.
- 2 Press **▲** or **▼** (or **↑** or **↓** on the remote) repeatedly until “**PATTERN**” appears.
- 3 Press **◀** or **▶** (or **←** or **→** on the remote) repeatedly to select the setting you want.

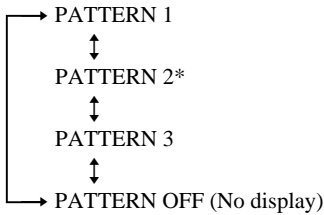

- 4 Press **ENTER**.

* “PATTERN 2” may not be displayed according to the audio signal.

Adjusting the brightness of the indicators

- 1 Press **AMP MENU** on the remote.
- 2 Press **▲** or **▼** (or **↑** or **↓** on the remote) repeatedly until “**DIMMER**” appears.
- 3 Press **◀** or **▶** (or **←** or **→** on the remote) repeatedly to select the setting you want.

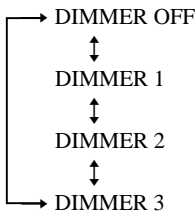

- 4 Press **ENTER**.

Singing along: Karaoke

(*MHC-RV900D and RV600D only*)

You can sing along by turning down the singer’s voice. You need to connect an optional microphone.

- 1 Turn **MIC LEVEL** to **MIN** to turn down the microphone control level.
- 2 Connect an optional microphone to **MIC**.
- 3 Press **KARAOKE PON** repeatedly to obtain the karaoke effect you desire.

Each time you press the button, the display changes cyclically as follows:

KARAOKE PON*¹ → MPX R*² → MPX L*² → Effect status*³

*¹ CD, VCD and DVD only

*² CD and VCD only

*³ KARAOKE PON is canceled.

To sing karaoke of multiplex CD, select “MPX R” or “MPX L”.

- 4 Start playing the music.
- 5 Adjust the microphone volume by turning **MIC LEVEL**.

continued

Singing along: Karaoke (continued)





Other Operations

To	Do this
Use VIDEO CDs or DVDs	Turn on your TV and switch it to the appropriate video input.
Cancel karaoke mode	Turn MIC LEVEL to MIN and disconnect the microphone from MIC, then press KARAOKE PON repeatedly until "MIC" disappears.
Adjust the microphone echo	Turn ECHO LEVEL to adjust the echo effect. To cancel the echoing, turn ECHO LEVEL to MIN.

Notes

- The instrumental sound may be reduced as well as the singer's voice when the sound is recorded in monaural.
- The singer's voice may not be reduced when:
 - only a few instruments are playing.
 - a duet is being played.
 - the source has strong echoes or chorus.
 - the singer's voice deviates from the center.
 - the voice on the source is singing in high soprano or tenor.
- If you connect the microphone while playing a 5.1CH DVD, the sound switches to 2CH.
- If the disc changes, karaoke mode is canceled.
- With some songs, vocals may not be canceled when you select "KARAOKE PON".
- During KARAOKE PON, equalizer and surround settings cannot be changed.
- If you press MUSIC EQ, MOVIE EQ, GAME EQ or EFFECT ON/OFF or recall a sound effect, the karaoke mode is canceled.

Mixing and recording sounds

- 1 Do the procedure for "Singing along" (steps 1 through 5). Then, load a recordable tape in deck B.**
- 2 Press the function button of the source you want to record (e.g., DVD).**
When you want to record from TAPE A, press TAPE A/B repeatedly until TAPE A is selected.
- 3 Press REC PAUSE/START.**
Deck B stands by for recording. "REC" flashes.
- 4 Press DIRECTION repeatedly to select  to record on one side. Select  (or RELAY) to record on both sides.**
- 5 Press REC PAUSE/START.**
- 6 Press  (or  on the remote) to start playing the source to be recorded.**
Start singing along with the music.

To stop recording

Press .

Tips

- If acoustic feedback (howling) occurs, move the microphone away from the speakers or change the direction of the microphone.
- If you want to record your voice through the microphone only, you can do so by selecting the DVD function and not playing a disc.
- When high level sound signals are input, the system automatically adjusts the recording level to prevent distortion of the recorded sound signal (Auto Level Control function).

Falling asleep to music

— Sleep Timer

You can set the system to turn off after a certain time, so that you can fall asleep to music.

Press SLEEP on the remote.

Each time you press the button, the minute display (the turn-off time) changes cyclically as follows:

AUTO* → 90 MIN → 80 MIN → 70 MIN
→ ... → 10 MIN → OFF

* The system turns off when the current disc or tape finishes playback (for up to 100 minutes).

Other Operations

To	Press
Check the remaining time	SLEEP on the remote once.
Change the time to turn off	SLEEP on the remote repeatedly to select the time you want.
Cancel the Sleep Timer function	SLEEP on the remote repeatedly until "SLEEP OFF" appears.

Waking up to music

— Daily Timer

You can wake up to music at a preset time. Make sure you have set the clock (see "Setting the clock" on page 16).

1 Prepare the music source you want to play.

- Disc: Load a disc. To start from a specific track, make a program (see "Creating your own program" on page 20).
- Tape: Load a tape with the side you want to play facing forward.
- Radio: Tune in the preset station you want (see "Listening to the radio" on page 44).

2 Adjust the volume.

3 Press CLOCK/TIMER SET on the remote.

"DAILY 1 SET" appears.

4 Press ▲ or ▼ (or ↑ or ↓ on the remote) repeatedly to select "DAILY 1 (or 2) SET", then press ENTER.

"ON" appears and the hour indication flashes.

continued

Waking up to music (continued)

5 Set the time to start playing.

Press ▲ or ▼ (or ↑ or ↓ on the remote) repeatedly to set the hour, then press ► (or ➡ on the remote).

The minute indication flashes.

Press ▲ or ▼ (or ↑ or ↓ on the remote) repeatedly to set the minute, then press ENTER.

The hour indication flashes again.

6 Repeat step 5 to set the time to stop playback.

7 Press ▲ or ▼ (or ↑ or ↓ on the remote) repeatedly until the music source you want appears.

The indication changes as follows:

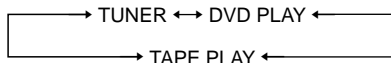

8 Press ENTER.

The type of timer (DAILY 1 or DAILY 2), followed by the start time, stop time, and the music source appear, then the original display appears.

9 Press I/⏻ to turn off the system.

Other Operations

To	Do this
Check the setting	Press CLOCK/TIMER SELECT on the remote and press ▲ or ▼ (or ↑ or ↓ on the remote) repeatedly to select the respective mode (DAILY 1 or DAILY 2), then press ENTER.
Change the setting	Start over from step 1.
Cancel the timer	Press CLOCK/TIMER SELECT on the remote and press ▲ or ▼ (or ↑ or ↓ on the remote) repeatedly to select "TIMER OFF", then press ENTER.

Tip

The system turns on 15 seconds before the preset time.

Notes

- You cannot activate DAILY 1 and DAILY 2 timer at the same time.
- When you use the Sleep Timer, the Daily Timer will not turn on the system until the Sleep Timer turns it off.
- You cannot activate Daily Timer and Timer-recording at the same time.
- If the system is on at the preset time, you cannot activate the Daily Timer.

Hooking up optional components

To enhance your system, you can connect optional components. Refer to the operating instructions provided with each component.

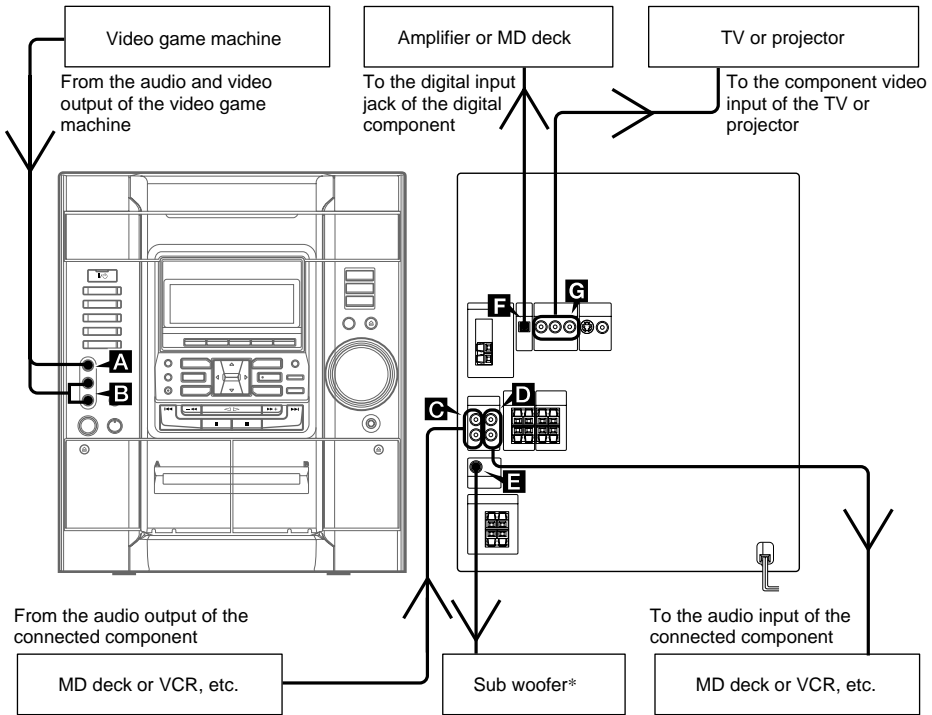

* MHC-RV900D and RV600D only

A VIDEO INPUT jack

Use a video cable (not supplied) to connect the video output of the optional video game machine to this jack.

B AUDIO INPUT jacks

Use audio cords (not supplied) to connect the audio output of the optional video game machine to these jacks. You can then output audio through this system. To listen to the analog sound of a connected video game, press GAME.

Notes

- To enjoy video game sound, see “Enhancing video game sound” on page 56, or see “Mixing video game sound with other sound source” on page 56 for video game sound effects.
- The video game machine image may appear on the TV screen even if the system is turned off.
- If you press GAME while the system is off, the system turns on, the function switches to GAME, and the equalizer also switches to the GAME EQ (previously selected effect).
- If you press GAME while the system is on, the function switches to GAME and the equalizer automatically switches to the GAME EQ (previously selected effect).

continued

Hooking up optional components (continued)

C MD (VIDEO)* IN jacks

Use audio cords (not supplied) to connect the audio output of the optional component (such as MD deck or VCR) to these jacks. You can then output audio through this system.

D MD (VIDEO)* OUT jacks

Use audio cords (not supplied) to connect the audio input of the optional component (such as MD deck or VCR) to these jacks. You can then make an analog recording from this system.

E SUB WOOFER OUT jack (MHC-RV900D and RV600D only)

Use speaker cord (not supplied) to connect the sub woofer speaker.

F DIGITAL OUT jack

Use a digital optical cable (square, not supplied) to connect the audio input of the optional digital component to this jack. You can then record digital audio from this system.

However, note that when playing a CD recorded in the DTS format, the DTS stream cannot be output to an amplifier, MD deck or other digital recording equipment capable of decoding the DTS stream.

G COMPONENT VIDEO OUT jacks

Use the component cable (not supplied) to connect the video input of the TV or projector to these jacks. Make sure to match the color of the plugs and the connectors.

* VIDEO (MD) for MHC-GX90D

Listening to audio from a connected component

Listening to a connected MD deck

1 Connect the audio cords.

See “Hooking up optional components” on page 61.

2 Press MD (VIDEO)*.

Start playing the connected component.

Listening to a connected VCR

1 Connect the audio cords.

See “Hooking up optional components” on page 61.

2 Press MD (VIDEO)*.

Hold down MD (VIDEO)* and press I/⏻. This switches the “MD” function to “VIDEO”. Once you enable the “VIDEO” function, just press MD (VIDEO)*.

Notes

- If you cannot select “MD” when you press MD (VIDEO)*, press I/⏻ while holding down MD (VIDEO)* when the system is on. “VIDEO” will be switched to “MD”. To return to “VIDEO”, repeat the same procedure.
- When you connect a VIDEO CD deck, set to “MD”.
- This function is factory-set to “MD” for MHC-RV900D, RV800D and RV600D, and “VIDEO” for MHC-GX90D.

* VIDEO (MD) for MHC-GX90D

Recording on a connected component

Making a digital recording on an MD

1 Connect an optical cable.

See “Hooking up optional components” on page 61.

2 Start recording.

Refer to the operating instructions provided with the connected component.

Making an analog recording

1 Connect the audio cords.

See “Hooking up optional components” on page 61.

2 Start recording.

Refer to the operating instructions provided with the connected component.

Making an analog recording from a VIDEO CD to a video tape

1 Connect optional audio cords from the MD/VIDEO (AUDIO) OUT jacks and the supplied video cable from the VIDEO OUT jack to your VCR.

2 Start recording.

Refer to the operating instructions provided with the connected component.

Note

You cannot record from a VIDEO CD to an MD digitally. When you record from a VIDEO CD to an MD, make an analog recording on MD.

Recording audio from a connected component

1 Connect audio cords.

See “Hooking up optional components” on page 61.

2 Start recording manually.

See “Recording from a disc/tape/radio manually” on page 48.

Problems and remedies

If you have any problem using this system, use the following check list.

First, check that the power cord is connected firmly and the speakers are connected correctly and firmly.

Should any problem persist, consult your nearest Sony dealer.

General

The display starts flashing as soon as you plug in the power cord even though you have not turned on the system (see step 7 of “Hooking up the system” on page 13).

- Press DISPLAY twice while the system is off. The demonstration disappears.

“- -: -” lights in the display.

- A power interruption occurred. Set the clock and timer settings again.

The clock setting/radio presetting/timer is canceled.

- The power cord is disconnected or a power failure occurs for longer than half a day. Redo the following:
 - “Setting the clock” on page 16
 - “Presetting radio stations” on page 43

If you have set the timer, also redo “Waking up to music” on page 59 and “Timer-recording radio programs” on page 50.

There is no sound.

- Turn VOLUME clockwise (or press VOL + on the remote).
- The headphones are connected.
- Insert only the stripped portion of the speaker cord into the SPEAKER jack. Inserting the vinyl portion of the speaker cord will obstruct the speaker connections.
- There is no audio output during timer recording.
- The system is in pause mode or in Slow-motion Play mode. Press ◀▶ (or ◀▶ on the remote) to return to normal play mode.

There is severe hum or noise.

- A TV or VCR is placed too close to the stereo system. Move the stereo system away from the TV or VCR.

The sound from the component connected to the MD (VIDEO) jacks (or VIDEO (MD) jacks for MHC-GX90D) is distorted.

- If “VIDEO” appears in the display when you press MD (VIDEO) (or VIDEO (MD) for MHC-GX90D), switch to “MD” function (see “Listening to audio from a connected component” on page 62).

The timer does not function.

- Set the clock correctly.

“DAILY 1”, “DAILY 2” and “REC” do not appear when you press CLOCK/TIMER SELECT on the remote.

- Set the timer correctly.
- Set the clock.

The remote does not function.

- There is an obstacle between the remote and the system.
- The remote is not pointing in the direction of the system’s sensor.
- The batteries have run down. Replace the batteries.

There is acoustic feedback.

- Reduce the volume.
- Move the microphone away from the speakers or change the direction of the microphone.

The color irregularity on a TV screen persists.

- Turn off the TV set once, then turn it on after 15 to 30 minutes. If the color irregularity still persists, place the speakers farther away from the TV set.
-

Speakers

Sound comes from one channel or unbalanced left and right volume.

- Check the speaker connection and speaker placement.
- The source being played back is monaural.
- Adjust the balance parameters (see pages 31, 33).

The sound comes from the center speaker only. (except for MHC-RV600D)

- Depending on the disc, the sound may come from the center speaker only.

There is no sound from the sub woofer.

- No sound is produced from the sub woofer when you play a DVD that does not have sub woofer output recorded.

There is no sound from the center speaker. (except for MHC-RV600D)

- Set the center speaker level to the appropriate level.

There is no sound from the rear speakers. (except for MHC-RV600D)

- Set the rear speakers level to the appropriate level.
- The software being played back has limited sound effects. Check the volume with the test tone.

Sound lacks bass.

- Check that the speaker's + and - jacks are connected correctly.
-

DVD/VIDEO CD/CD/MP3 Player

There is no picture.

- Check that the player is connected securely.
- Make sure you operate the TV correctly.
- Make sure you set the color system correctly, according to your TV (color) system.
- Press DVD.
- Make sure Game Mixing is canceled.

The disc tray does not close.

- The disc is not placed properly.

The disc will not play.

- The disc is not lying flat in the disc tray.
- The disc is dirty.
- The disc is loaded label side down.
- There is moisture on the disc.
- The region code on the DVD does not match the system.

Play does not start from the first track.

- The player is in Program or Shuffle Play mode. Press PLAY MODE repeatedly until "PGM" or "SHUF" disappears.
- Resume Play has been selected. Press ■ in stop mode, then start playback (see page 22).
- The title, DVD or PBC menu automatically appears on the screen.

Playback starts automatically.

- The DVD features an auto playback function.

Playback stops automatically.

- Some discs may contain an auto pause signal. While playing such a disc, the playback stops at the auto pause signal.

You cannot perform some functions such as Stop, Search, Slow-motion Play, Repeat Play, Shuffle Play, or Program Play.

- Depending on the disc, you may not be able to do some of the operations above. Refer to the operating instructions supplied with the disc.

continued

Problems and remedies (continued)

MP3 audio track cannot be played back.

- Recording was not performed according to the ISO 9660 level 1 or level 2 format, or Joliet in the expansion format.
- The MP3 audio track does not have the extension “.MP3”.
- The data is not stored in MP3 format.
- Discs containing files other than MPEG 1 Audio Layer-3 files cannot be played.

MP3 audio tracks take longer to play back than others.

- After the system reads all tracks on the disc, playback may take more time than usual if:
 - the number of albums or tracks on the disc is very large.
 - the album and track organization structure is very complex.

The album title, track title and ID3 tag do not appear correctly.

- The CD was not recorded in conformance with ISO 9660 level 1, level 2 or Joliet. Use a CD that conforms with ISO 9660 level 1, level 2 or Joliet.
- The disc ID3 tag is not ver. 1.0.

The album title, track title and ID3 tag appear as spaces. The CD characters appear as spaces.

- The character codes that can be displayed by this system are numbers and alphabet only. Other characters appear as spaces.

The disc tray does not open and “LOCKED” appears.

- Contact your Sony dealer or local authorized Sony service facility.
-

Picture

There is no picture.

- Press DVD.
- Check that the system is connected securely.
- The video cable is damaged. Replace it with a new one.
- Make sure you connect the system to the video input jack of your TV (see page 13).
- Make sure you turn on the TV.
- Make sure you select the video input on the TV so that you can view the pictures from the system.
- Make sure you connect the system and your TV using only the supplied video cable so that you can view game images.

Picture noise appears.

- Clean the disc.
- If video from your DVD player has to go through your VCR to get to your TV, the copy-protection applied to some DVD programs could affect picture quality. If you still experience problems after checking your connections, please try connecting your DVD player directly to your TV's S video-input, if your TV is equipped with this input (see page 13).
- The color system is different. Set the color system to match your TV (see page 13).

The aspect ratio of the screen cannot be changed even though you set “TV TYPE” in “SCREEN SETUP” in the Setup Display when you play a wide picture.

- The aspect ratio is fixed on your DVD.
- If you connect the system with the S-video cable, connect directly to the TV. Otherwise, you may not change the aspect ratio.
- Depending on the TV, you may not change the aspect ratio.

Messages do not appear on the screen in the language you want.

- Select the language you want for the on-screen display in “OSD” under “LANGUAGE SETUP” in the Setup Display (see page 29).

The language for the sound track cannot be changed.

- Multilingual tracks are not recorded on the DVD being played.
- The DVD prohibits changing the language for the sound track.

The subtitle language cannot be changed.

- Multilingual subtitles are not recorded on the DVD being played.
- The DVD prohibits changing the subtitles.

The subtitle cannot be turned off.

- The DVD prohibits turning off subtitles.

The angles cannot be changed.

- Multi-angles are not recorded on the DVD being played.
- The DVD prohibits changing the angles.

A 5-character service number is displayed on the screen and on the display.

- The self-diagnosis function is activated. (See the table on page 69.)

Tape Deck

The tape does not record.

- No tape in the cassette holder.
- The tab has been removed from the cassette (see “To save a tape permanently” on page 70).
- The tape has reeled to the end.

The tape does not record nor play or there is a decrease in sound level.

- The heads are dirty (see “Cleaning the tape heads” on page 70).
- The record/playback heads are magnetized (see “Demagnetizing the tape heads” on page 70).

The tape does not erase completely.

- The record/playback heads are magnetized (see “Demagnetizing the tape heads” on page 70).

There is excessive wow or flutter, or the sound drops out.

- The capstans or pinch rollers are dirty (see “Cleaning the tape heads” on page 70).

Noise increases or the high frequencies are erased.

- The record/playback heads are magnetized (see “Demagnetizing the tape heads” on page 70).

Tuner

There is severe hum or noise (“TUNED” or “STEREO” flashes in the display).

- Adjust the antenna.
- The signal strength is too weak. Connect the external antenna.

A stereo FM program cannot be received in stereo.

- Press FM MODE repeatedly until “MONO” disappears.

continued

Optional components

There is no sound.

- Refer to General item “There is no sound.” on page 64 and check the condition of the system.
 - Connect the component properly (see page 61) while checking:
 - if the cords are connected properly.
 - if the cord plugs are firmly inserted all the way.
 - Turn on the connected component.
 - Refer to the operating instructions included with the connected component and start playing.
-

If other troubles not described above occur, reset the system as follows:

- 1 Unplug the power cord.
- 2 Plug the power cord back in.
- 3 Press **■**, **ENTER**, and **I/⏻** at the same time.
- 4 Press **I/⏻** to turn on the system.

The system is reset to the factory settings except for DVD settings. All the settings other than DVD settings you made are cleared.

Note

Turn off the sub woofer before you reset the system.

Messages

One of the following messages may appear or flash in the display during operation.

NO DISC

- There is no disc in the disc tray.
-

“PROTECT” and “PUSH POWER” appear alternately.

- A strong signal was input. Press **I/⏻** to turn off the system, leave the system turned off for a while, then press **I/⏻** again to turn on the system. If “PROTECT” and “PUSH POWER” appear alternately even after the system is turned on again, press **I/⏻** to turn off the system and check the speaker cord.
-

PUSH STOP

- You pressed **PLAY MODE** during play.
-

READING

- The system is reading the TOC information of the disc. Some buttons are not available.
-

WAIT

- The function is switching to the tuner.
-

The disc tray does not open and “LOCKED” appears.

- Contact your Sony dealer or local authorized Sony service facility.
-

Self-diagnosis function

(When letters/numbers appear in the display)

When the self-diagnosis function is activated to prevent the system from malfunctioning, a five-character service number (e.g., C 13 00) with a combination of a letter and digits appears on the screen. In this case, check the following table.

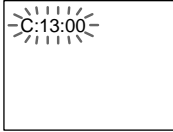

First three characters of the service number	Cause and/or corrective action
C 13	The disc is dirty. ➔ Clean the disc with a soft cloth (see page 70).
C 31	The disc is not inserted correctly. ➔ Re-insert the disc correctly.
E XX (XX is a number)	To prevent a malfunction, the system has performed the self-diagnosis function. ➔ Contact your nearest Sony dealer or local authorized Sony service facility and give the 5-character service number. Example: E 61 10

Precautions

On operating voltage

Before operating the system, check that the operating voltage of your system is identical with the voltage of your local power supply.

On safety

- The unit is not disconnected from the AC power source (mains) as long as it is connected to the wall outlet, even if the unit itself has been turned off.
- Unplug the system from the wall outlet (mains) if it is not to be used for an extended period of time. To disconnect the cord (mains lead), pull it out by the plug. Never pull the cord itself.
- Should any solid object or liquid fall into the component, unplug the system and have it checked by qualified personnel before operating it any further.
- The AC power cord must be changed only at a qualified service shop.

On placement

- Do not place the system in an inclined position.
- Do not place the system in locations where it is:
 - Extremely hot or cold
 - Dusty or dirty
 - Very humid
 - Subject to vibrations
 - Subject to direct sunlight.
- Use caution when placing the unit or speakers on surfaces that have been specially treated (with wax, oil, polish, etc.) as staining or discoloration of the surface may result.

On heat build up

- Although the system heats up during operation, this is not a malfunction.
- Place the system in a location with adequate ventilation to prevent heat build up in the system.
- If you continuously use this system at a large volume, the cabinet temperature of the top, side and bottom rises considerably. To avoid burning yourself, do not touch the cabinet.
- To prevent a malfunction, do not cover the ventilation hole for the cooling fan.

continued

Precautions (continued)

On operation

- If the system is brought directly from a cold to a warm location, or is placed in a very damp room, moisture may condense on the lens inside the CD player. Should this occur, the system will not operate properly. Remove the CD and leave the system turned on for about an hour until the moisture evaporates.
- When you move the system, take out any discs.

If you have any questions or problems concerning your stereo system, please consult your nearest Sony dealer.

Notes on discs

- Before playing, clean the CD with a cleaning cloth. Wipe the CD from the center out.
- Do not use solvents.
- Do not expose the CD to direct sunlight or heat sources.
- Discs with non-standard shapes (e.g., heart, square, star) cannot be played on this unit. Attempting to do so may damage the unit. Do not use such discs.

Cleaning the cabinet

Use a soft cloth slightly moistened with mild detergent solution.

To save a tape permanently

To prevent a tape from being accidentally recorded over, break off the cassette tab from side A or B as illustrated. If you later want to reuse the tape for recording, cover the broken tab with adhesive tape.

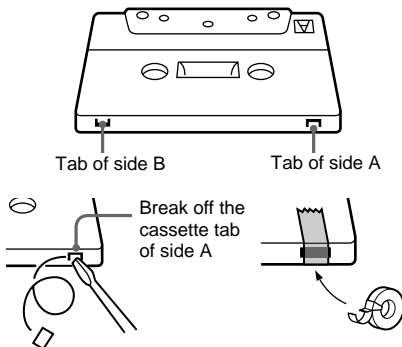

Before placing a cassette in the tape deck

Take up any slack in the tape. Otherwise the tape may get entangled in the parts of the tape deck and become damaged.

When using a tape longer than 90 minutes

The tape is very elastic. Do not change the tape operations such as play, stop, and fast-winding frequently. The tape may get entangled in the tape deck.

Cleaning the tape heads

Clean the tape heads after every 10 hours of use.

Be sure to clean the tape heads before you start an important recording or after playing an old tape. Use a separately sold dry-type or wet-type cleaning cassette. For details, refer to the instructions of the cleaning cassette.

Demagnetizing the tape heads

Demagnetize the tape heads and the metal parts that have contact with the tape every 20 to 30 hours of use with a separately sold demagnetizing cassette. For details, refer to the instructions of the demagnetizing cassette.

Specifications

Amplifier section

MHC-GX90D

Continuous RMS power output (reference)

Front speaker:	60 + 60 watts (6 ohms at 1 kHz, 10% THD)
Center speaker:	45 watts (8 ohms at 1 kHz, 10% THD)
Rear speaker:	40 + 40 watts (6 ohms at 1 kHz, 10% THD)
Sub woofer:	55 watts (4 ohms at 1 kHz, 10% THD)
Total harmonic distortion	less than 0.07% (6 ohms at 1 kHz, 70 watts)

MHC-RV800D

DIN power output

Front speaker:	45 + 45 watts (6 ohms at 1 kHz, DIN)
Center speaker:	33 watts (8 ohms at 1 kHz, DIN)
Rear speaker:	30 watts (6 ohms at 1 kHz, DIN)
Sub woofer:	38 watts (4 ohms at 1 kHz, DIN)
Continuous RMS power output (reference)	
Front speaker:	60 + 60 watts (6 ohms at 1 kHz, 10% THD)
Center speaker:	45 watts (8 ohms at 1 kHz, 10% THD)
Rear speaker:	40 + 40 watts (6 ohms at 1 kHz, 10% THD)
Sub woofer:	55 watts (4 ohms at 1 kHz, 10% THD)

Music power output (reference)

Front speaker:	120 + 120 watts (6 ohms at 1 kHz, 10% THD)
Center speaker:	90 watts (8 ohms at 1 kHz, 10% THD)
Rear speaker:	80 + 80 watts (6 ohms at 1 kHz, 10% THD)
Sub woofer:	110 watts (4 ohms at 1 kHz, 10% THD)

MHC-RV900D

The following measured at AC 220 V, 50/60 Hz

Continuous RMS power output (reference)

Front speaker:	100 + 100 watts (6 ohms at 1 kHz, 10% THD)
Center speaker:	40 watts (8 ohms at 1 kHz, 10% THD)
Rear speaker:	40 + 40 watts (6 ohms at 1 kHz, 10% THD)

MHC-RV600D

The following measured at AC 220 V, 50/60 Hz

DIN power output (rated)	100 + 100 watts (6 ohms at 1 kHz, DIN)
Continuous RMS power output (reference)	
	100 + 100 watts (6 ohms at 1 kHz, 10% THD)

Inputs

MD/VIDEO (AUDIO) IN (phono jacks):	voltage 450/250 mV, impedance 47 kilohms
GAME (AUDIO) IN (phono jack):	voltage 250 mV, impedance 47 kilohms
MIC (phone jack) (except for MHC-GX90D and RV800D):	sensitivity 1 mV, impedance 10 kilohms

Outputs

MD/VIDEO (AUDIO) OUT (phono jacks):	voltage 250 mV, impedance 1 kilohm
VIDEO OUT (phono jack):	max. output level 1 Vp-p, unbalanced, Sync negative, load impedance 75 ohms
S-VIDEO OUT (4-pin/mini-DIN jack):	Y: 1 Vp-p, unbalanced, Sync negative, C: 0.286 Vp-p, load impedance 75 ohms

continued

Specifications (continued)

COMPONENT VIDEO OUT:

Y: 1 V_{p-p}, 75 ohms
Pb, Pr: 0.7 V_{p-p}, 75 ohms

PHONES (stereo mini jack):

accepts headphones of
8 ohms or more

Front speaker:

accepts impedance of 6 to
16 ohms

Rear speaker (except for MHC-RV600D):

accepts impedance of
24 ohms

Center speaker (except for MHC-RV600D):

accepts impedance of
24 ohms

Sub woofer speaker (MHC-GX90D and RV800D only):

accepts impedance of
12 to 16 ohms

SUB WOOFER OUT (MHC-RV900D and RV600D only):

voltage 1 V,
impedance 1 kilohm

Disc player section

System Compact disc and digital audio and video system

Laser Semiconductor laser
(DVD: $\lambda=650$ nm,
CD: $\lambda=780$ nm)
Emission duration:
continuous

Wavelength 780 – 790 nm

Frequency response DVD (PCM 48 kHz):
2 Hz – 22 kHz (± 1 dB)
CD: 2 Hz – 20 kHz
(± 1 dB)

Video color system format NTSC, PAL

CD OPTICAL DIGITAL OUT

(Square optical connector jack, rear panel)

Wavelength 660 nm

Output Level –18 dBm

Tape deck section

Recording system 4-track 2-channel stereo
Frequency response 40 – 13,000 Hz (± 3 dB),
using Sony TYPE I
cassette
Wow and flutter $\pm 0.15\%$ W.Peak (IEC)
 0.1% W.RMS (NAB)
 $\pm 0.2\%$ W.Peak (DIN)

Tuner section

FM stereo, FM/AM superheterodyne tuner

FM tuner section

Tuning range 87.5 – 108.0 MHz
Antenna FM lead antenna
Antenna terminals 75 ohm unbalanced
Intermediate frequency 10.7 MHz

AM tuner section

Tuning range 531 – 1,602 kHz (with the
interval set at 9 kHz)
530 – 1,710 kHz (with the
interval set at 10 kHz)
Antenna AM loop antenna
Antenna terminals External antenna terminal
Intermediate frequency 450 kHz

Speaker

Front speaker SS-RG99 for MHC-GX90D and RV800D

Speaker system	3-way, 3-unit, bass-reflex type, magnetically shielded type
Speaker units	
Mid:	5 cm, cone type
Woofers:	13 cm, cone type
Tweeter:	2 cm, cone type
Nominal impedance	6 ohms
Dimensions (w/h/d)	Approx. 200 × 325 × 237 mm
Mass	Approx. 3.0 kg net per speaker

Front speaker SS-RV900 for MHC-RV900D and RV600D

Speaker system	3-way, 3-unit, bass-reflex type, magnetically shielded type
Speaker units	
Woofers:	13 cm, cone type
Sub woofer:	13 cm, cone type
Tweeter:	5 cm, cone type
Nominal impedance	6 ohms
Dimensions (w/h/d)	Approx. 215 × 356 × 285 mm
Mass	Approx. 4.5 kg net per speaker

Rear speaker SS-RS390 for MHC-GX90D, RV900D and RV800D

Speaker system	1-way, 1-unit, bass-reflex type
Speaker units	
Full-range:	8 cm, cone type
Nominal impedance	6 ohms
Dimensions (w/h/d)	Approx. 165 × 95 × 99 mm
Mass	Approx. 0.7 kg net per speaker

Center speaker SS-CT390 for MHC-GX90D, RV900D and RV800D

Speaker system	1-way, 1-unit, bass-reflex type, magnetically shielded type
Speaker units	
Full-range:	8 cm, cone type
Nominal impedance	8 ohms
Dimensions (w/h/d)	Approx. 225 × 95 × 100 mm
Mass	Approx. 0.9 kg net per speaker

Sub woofer speaker SS-WG99 for MHC-GX90D and RV800D

Speaker system	passive sub woofer
Speaker units	
Woofers:	15 cm, cone type
Nominal impedance	4 ohms
Dimensions (w/h/d)	Approx. 210 × 325 × 239 mm
Mass	Approx. 3.5 kg net per speaker

General

Power requirements	220 V AC, 50/60 Hz
--------------------	--------------------

continued

Specifications (continued)

Power consumption	
MHC-GX90D	270 watts
MHC-RV800D	270 watts
	0.25 watts (in Power Saving Mode)
MHC-RV900D	300 watts
	0.4 watts (in Power Saving Mode)
MHC-RV600D	230 watts
	0.4 watts (in Power Saving Mode)
Dimensions (w/h/d)	
MHC-GX90D/RV900D/RV600D	Approx. 280 × 325 × 368 mm
MHC-RV800D	Approx. 280 × 325 × 370 mm
Mass	
MHC-GX90D	Approx. 11.1 kg
MHC-RV900D	Approx. 12.1 kg
MHC-RV800D	Approx. 11.3 kg
MHC-RV600D	Approx. 10.6 kg
Supplied accessories:	Remote Commander (1)
	Batteries (2)
	AM loop antenna (1)
	FM lead antenna (1)
	Video cable (1)
	Speaker pads
	MHC-GX90D (14)
	MHC-RV900D (10)
	MHC-RV800D (14)
	MHC-RV600D (8)
	Rear speaker cable (except for MHC-RV600D) (2)

Design and specifications are subject to change without notice.

Glossary

Album

Section of a music piece on a data CD containing MP3 audio tracks.

Auto Pause

An automatic pause according to the signal encoded on the disc while playing a VIDEO CD. If the CD player does not resume play for a long time, press ◀▶ (or ◀▶ on the remote) to resume play manually.

Chapter

Sections of a picture or a music piece on a DVD that are smaller than titles. A title is composed of several chapters.

Dolby Digital

This sound format for movie theaters is more advanced than Dolby Pro Logic Surround. In this format, the rear speakers output stereo sound with an expanded frequency range and a sub woofer channel for deep bass is independently provided. This format is also called “5.1” because the sub woofer channel is counted as 0.1 channel (since it functions only when a deep bass effect is needed). All six channels in this format are recorded separately to realize superior channel separation. Furthermore, since all the signals are processed digitally, less signal degradation occurs.

DTS

Digital audio compression technology that the Digital Theater Systems, Inc. developed. This technology conforms to 5.1-channel surround. The rear channel is stereo and there is discrete sub woofer channel in this format. DTS provides the same 5.1 discrete channels of high quality digital audio. The good channel separation is realized because the all channel data is recorded discrete and processed in digital.

DVD

A disc that contains up to 8 hours of moving pictures even though its diameter is the same as a CD.

The data capacity of a single-layer and single-sided DVD, at 4.7 GB (Giga Byte), is 7 times that of a CD. Furthermore, the data capacity of a dual-layer and single-sided DVD is 8.5 GB, a single-layer and double-sided DVD 9.4 GB, and a dual-layer and double-sided DVD 17 GB.

The picture data uses the MPEG 2 format, one of the worldwide standards for digital compression technology. The picture data is compressed to about 1/40 of its original size. The DVD also uses variable rate coding technology that changes the data to be allocated according to the status of the picture.

The audio data is recorded in Dolby Digital as well as in PCM, allowing you to enjoy more real audio presence. Furthermore, various advanced functions such as the multi-angle, multilingual, and Parental Control functions are provided with the DVD.

Index (CD)/Video Index (VIDEO CD)

A number that divides a track into sections to easily locate the point you want on a VIDEO CD or a CD. Depending on the disc, no indexes may be recorded.

Menu Playback

Playback using the menu screens recorded on VIDEO CDs with PBC functions. You can enjoy simple interactive software using the menu playback function.

Multi-angle function

Various angles, or viewpoints of the video camera, for a scene are recorded on some DVDs.

Multilingual function

Several languages for the sound or subtitles in a picture are recorded on some DVDs.

Parental Control

A function of the DVD to limit playback of the disc by the age of the users according to the limitation level in each country. The limitation varies from disc to disc; when it is activated, playback is completely prohibited, violent scenes are skipped or replaced with other scenes and so on.

Playback Control (PBC)

Signals encoded on VIDEO CDs (Version 2.0) to control playback. By using menu screens recorded on VIDEO CDs with PBC functions, you can enjoy playing simple interactive software, software with search functions, and so on.

continued

Glossary (continued)

Region Code

This system is used to protect copyrights. A region number is allocated on each DVD system or DVD disc according to the sales region. Each region code is shown on the system as well as on the disc packaging. The system can play the discs that match its region code. The system can also play discs with the “” mark. Even when the region code is not shown on the DVD, the region limit may still be activated.

Scene

On a VIDEO CD with PBC functions (see page 27), the menu screens, moving pictures, and still pictures are divided into sections called “scenes”.

Title

The longest sections of a picture or a music piece on a DVD; a movie, etc., for a picture piece on video software; or an album, etc., for a music piece on audio software.

Track

Sections of a picture or a music piece on a CD, VIDEO CD or MP3.

VIDEO CD

A compact disc which contains moving pictures.

VIDEO CDs contain compact picture information using the MPEG 1 format, one of the worldwide standards for digital compression technology. The picture information is compressed about 120 times. Consequently, a 12 cm VIDEO CD can contain up to 74 minutes of moving pictures.

VIDEO CDs also contain compact audio information. Sounds outside the range of human hearing are compressed while the sounds we can hear are not compressed. VIDEO CDs can hold six times the audio information of conventional audio CDs.

There are two versions for VIDEO CDs:

Version 1.1 (VIDEO CDs without PBC functions):

You can play only moving pictures and sounds.

Version 2.0 (VIDEO CDs with PBC functions):

You can play still pictures and enjoy PBC functions.

This player can play both versions.

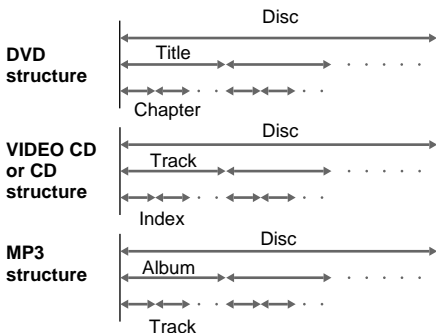

Language code list

For details, see pages 29, 35 and 38.

The language spellings conform to the ISO 639: 1988 (E/F) standard.

Code	Language	Code	Language	Code	Language	Code	Language
1027	Afar	1186	Scots Gaelic	1350	Malayalam	1513	Siswati
1028	Abkhazian	1194	Galician	1352	Mongolian	1514	Sesotho
1032	Afrikaans	1196	Guarani	1353	Moldavian	1515	Sundanese
1039	Amharic	1203	Gujarati	1356	Marathi	1516	Swedish
1044	Arabic	1209	Hausa	1357	Malay	1517	Swahili
1045	Assamese	1217	Hindi	1358	Maltese	1521	Tamil
1051	Aymara	1226	Croatian	1363	Burmese	1525	Telugu
1052	Azerbaijani	1229	Hungarian	1365	Nauru	1527	Tajik
1053	Bashkir	1233	Armenian	1369	Nepali	1528	Thai
1057	Byelorussian	1235	Interlingua	1376	Dutch	1529	Tigrinya
1059	Bulgarian	1239	Interlingue	1379	Norwegian	1531	Turkmen
1060	Bihari	1245	Inupiak	1393	Occitan	1532	Tagalog
1061	Bislama	1248	Indonesian	1403	(Afan) Oromo	1534	Setswana
1066	Bengali; Bangla	1253	Icelandic	1408	Oriya	1535	Tonga
1067	Tibetan	1254	Italian	1417	Punjabi	1538	Turkish
1070	Breton	1257	Hebrew	1428	Polish	1539	Tsonga
1079	Catalan	1261	Japanese	1435	Pashto; Pushto	1540	Tatar
1093	Corsican	1269	Yiddish	1436	Portuguese	1543	Twi
1097	Czech	1283	Javanese	1463	Quechua	1557	Ukrainian
1103	Welsh	1287	Georgian	1481	Rhaeto-Romance	1564	Urdu
1105	Danish	1297	Kazakh	1482	Kirundi	1572	Uzbek
1109	German	1298	Greenlandic	1483	Romanian	1581	Vietnamese
1130	Bhutani	1299	Cambodian	1489	Russian	1587	Volapük
1142	Greek	1300	Kannada	1491	Kinyarwanda	1613	Wolof
1144	English	1301	Korean	1495	Sanskrit	1632	Xhosa
1145	Esperanto	1305	Kashmiri	1498	Sindhi	1665	Yoruba
1149	Spanish	1307	Kurdish	1501	Sangho	1684	Chinese
1150	Estonian	1311	Kirghiz	1502	Serbo-Croatian	1697	Zulu
1151	Basque	1313	Latin	1503	Singhalese	1703	Not specified
1157	Persian	1326	Lingala	1505	Slovak		
1165	Finnish	1327	Laothian	1506	Slovenian		
1166	Fiji	1332	Lithuanian	1507	Samoan		
1171	Faroese	1334	Latvian; Lettish	1508	Shona		
1174	French	1345	Malagasy	1509	Somali		
1181	Frisian	1347	Maori	1511	Albanian		
1183	Irish	1349	Macedonian	1512	Serbian		

Control Menu item list

Control Menu items	Function
DISC	Displays the disc name inserted into the system. Selects the disc to be played.
TITLE (DVD only) SCENE (VIDEO CD in PBC Playback only) TRACK (VIDEO CD or CD) ALBUM (MP3 only)	Selects the title (DVD), the scene (VIDEO CD in PBC Playback), the track (VIDEO CD or CD), or the album (MP3) to be played.
CHAPTER (DVD only) INDEX (VIDEO CD or CD)	Selects the chapter (DVD) or the index (VIDEO CD or CD) to be played.
TRACK (MP3 only)	Selects the track to be played.
TIME	Checks the elapsed time and the remaining playback time. Inputs the time code for picture and music searching.
AUDIO (DVD/VIDEO CD/ CD only)	Changes the audio setting.
SUBTITLE (DVD only)	Displays the subtitles. Changes the subtitle language.
ANGLE (DVD only)	Changes the angle.
PLAY MODE	Selects the play mode (Normal Play/Shuffle Play/Program Play) for one disc or all discs in the disc tray.
REPEAT	Plays the entire disc (all titles/all tracks) repeatedly or one title/chapter/album/track repeatedly.
CUSTOM PARENTAL CONTROL	Sets the disc to prohibit playback.

Tips

- Each time you press DVD DISPLAY, the Control Menu display changes cyclically as follows:
Control Menu display → Control Menu display off
The Control Menu items differ depending on the disc.
- The Control Menu icon indicator lights in green when you select any item except “OFF” (“REPEAT” only). The “ANGLE” indicator lights in green only when the angles can be changed.

Setup Display item list

You can set the following items in the Setup Display.

The order of the displayed items may be different from the actual display.

LANGUAGE

- OSD — (Select the language you want to use from the displayed language list.)
- DVD MENU — (Select the language you want to use from the displayed language list.)
- AUDIO — (Select the language you want to use from the displayed language list.)
- SUBTITLE — (Select the language you want to use from the displayed language list.)

CUSTOM

- VCD COLOR SYSTEM —
 - AUTO
 - PAL
 - NTSC
- TRACK SELECTION —
 - OFF
 - AUTO
- PARENTAL CONTROL —
 - LEVEL —
 - OFF
 - 8.
 - 7. NC17
 - 6. R
 - 5.
 - 4. PG13
 - 3. PG
 - 2.
 - 1. G
 - STANDARD —
 - USA
 - OTHERS →
 - CHANGE PASSWORD

continued

SCREEN

- TV TYPE —
 - 4:3 LETTER BOX
 - 4:3 PAN SCAN
 - 16:9
- SCREEN SAVER —
 - ON
 - OFF
- BACKGROUND —
 - JACKET PICTURE
 - GRAPHICS
 - BLUE
 - BLACK

Setup Display item list (continued)

SPEAKER

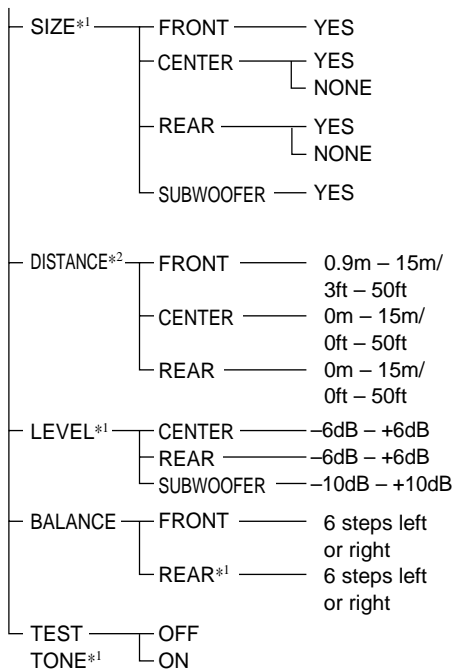

RESET

– YES

*1 Except for MHC-RV600D

*2 For “DISTANCE” in SPEAKER setup, the North American model’s OSD displays both metric and imperial measurements. The other models display metric measurements only.