

Mini Hi-Fi Component System

Operating Instructions



Game SYNC

MHC-VX333

WARNING

To prevent fire or shock hazard, do not expose the unit to rain or moisture.

To avoid electrical shock, do not open the cabinet. Refer servicing to qualified personnel only.

To prevent fire, do not cover the ventilation of the apparatus with news papers, table-cloths, curtains, etc. And don't place lighted candles on the apparatus.

To prevent fire or shock hazard, do not place objects filled with liquids, such as vases, on the apparatus.

Do not install the appliance in a confined space, such as a bookcase or built-in cabinet.

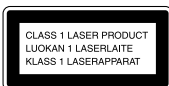

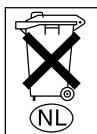

This appliance is classified as a CLASS 1 LASER product. The CLASS 1 LASER PRODUCT MARKING is located on the rear exterior.



Don't throw a battery, dispose it as the injurious wastes.

This system can play the following discs

	VIDEO CDs	Audio CDs
Disc Logo		
Contents	Audio + Video (moving pictures)	Audio
Disc size	12 cm/8 cm	12 cm/8 cm
Play time	74 min./20 min.	74 min./20 min.

Note on VIDEO CDs

This system conforms to VIDEO CDs without PBC functions (Ver. 1.1) and VIDEO CDs with PBC functions (Ver. 2.0) of VIDEO CD standards. You can enjoy two kinds of playback according to the disc type.

Disc type	You can
VIDEO CDs without PBC functions (Ver. 1.1 discs)	Enjoy video playback (moving pictures) as well as audio CDs.
VIDEO CDs with PBC functions (Ver. 2.0 discs)	Play interactive software using menu screens displayed on the TV screen (menu playback), in addition to the video playback function of VIDEO CDs without PBC functions. Moreover, you can play high or standard quality still picture.

* PBC = Play Back Control

Table of Contents

Parts Identification

Main unit	4
Remote Control	5

Getting Started

Hooking up the system	6
Inserting two R6 (size AA) batteries into the remote	8
Setting the time	9
Saving the power in standby mode	9

CD/VIDEO CD

Loading a CD/VIDEO CD	10
Playing a CD	
— Normal Play/Shuffle Play/ Repeat Play	10
Programing CD tracks	
— Program Play	11
Playing a VIDEO CD	
— Normal Play/Shuffle Play/ Repeat Play	12
Playing a VIDEO CD with PBC functions (Ver. 2.0)	
— PBC Play	13
Using the CD display	14
Using the on-screen display	15
Locating a specific part of a disc	
— Time Search/Disc Digest/Track Digest	16
Resuming playback from the point you stopped a VIDEO CD	
— Resume Play	18
Adjusting the picture	
— Picture Effect	18

Tuner

Presetting radio stations	19
Listening to the radio	
— Preset Tuning	20

Tape

Loading a tape	20
Playing a tape	21
Recording to a tape	
— CD Synchro Recording/Recording Manually/Program Edit	22
Timer-recording radio programs	23

Sound Adjustment

Adjusting the sound	24
Selecting the sound effect	24
Adjusting the graphic equalizer and storing	25
Selecting the surround effect	26

Other Features

Enhancing video game sound	
— Game Sync	26
Changing the spectrum analyzer display	26
Singing along: Karaoke	26
Falling asleep to music	
— Sleep Timer	28
Waking up to music	
— Daily Timer	28

Optional Components

Hooking up the optional A/V components	29
Connecting a video game machine	30

Additional Information

Precautions	31
Troubleshooting	33
Messages	35
Specifications	35
Glossary	37

The items are arranged in alphabetical order. Refer to the pages indicated in parentheses for details.

Main unit

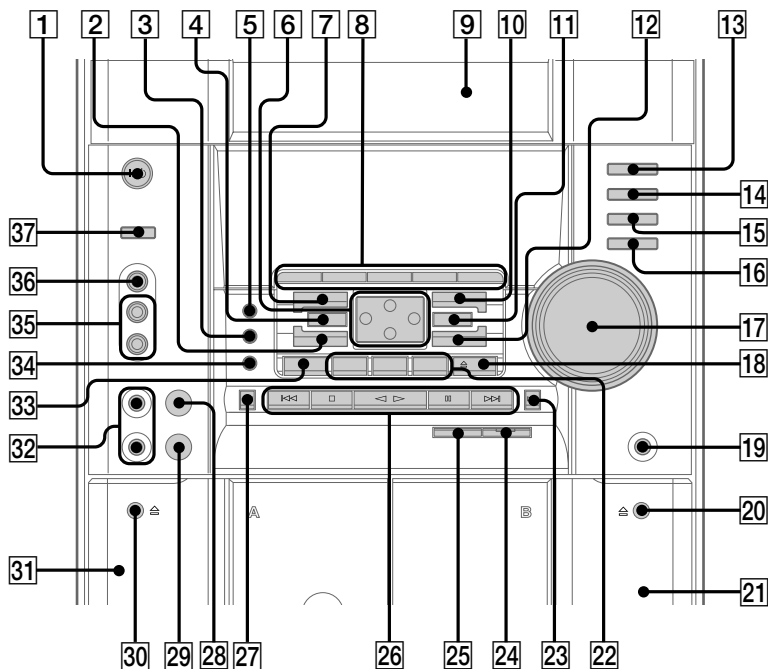

AUDIO jacks **35** (30)
 CD **13** (10 – 13, 22, 23)
 CD SYNC **25** (22, 23)
 Deck A **31** (20, 21)
 Deck B **21** (20 – 24)
 DIRECTION **8** (21 – 23, 27)
 DISC 1 – 3 **22** (10, 11, 13)
 DISC SKIP EX-CHANGE **33**
 (10, 11, 13)
 Disc tray **9** (10)
 DISPLAY **8** (9, 14)
 ECHO LEVEL control **28** (27)
 EDIT **8** (23)
 EFFECT ON/OFF **4**
 (25, 27)
 ENTER **11** (9, 13, 14, 18, 19,
 23 – 25, 28, 29, 35)
 GAME **37** (26, 30)
 GAME EQ **2** (24, 26)
 GROOVE **5** (24)
 KARAOKE PON **34** (27)

MD (VIDEO) **16** (30)
 MIC 1, 2 jack **32** (26, 27)
 MIC LEVEL control **29** (26, 27)
 MOVIE EQ **10** (24, 25)
 MUSIC EQ **7** (24, 25)
 P FILE **12** (25)
 PHONES jack **19**
 PICTURE EFFECT **3** (18)
 PLAY MODE **8** (10 – 12)
 REC PAUSE/START **24** (22, 23)
 REPEAT **8** (11)
 SPECTRUM **8** (26)
 STEREO/MONO **8** (20)
 TAPE A/B **15** (20, 22)
 TUNER MEMORY **8** (19)
 TUNER/BAND **14** (19, 22)
 VIDEO jack **36** (30)
 VOLUME control **17**

BUTTON DESCRIPTIONS

I/⏻ (power) **1**
 ▲▼◀▶ **6**
 ▲ OPEN/CLOSE **18**
 ▲ (deck B) **20**
 ▶▶ (fast forward) **23**
 + **23**
 ◀◀ (go back) **26**
 ▶▶ (go forward) **26**
 || (pause) **26**
 ◀▶ (play) **26**
 ■ (stop) **26**
 ◀◀ (rewind) **27**
 – **27**
 ▲ (deck A) **30**

Remote Control

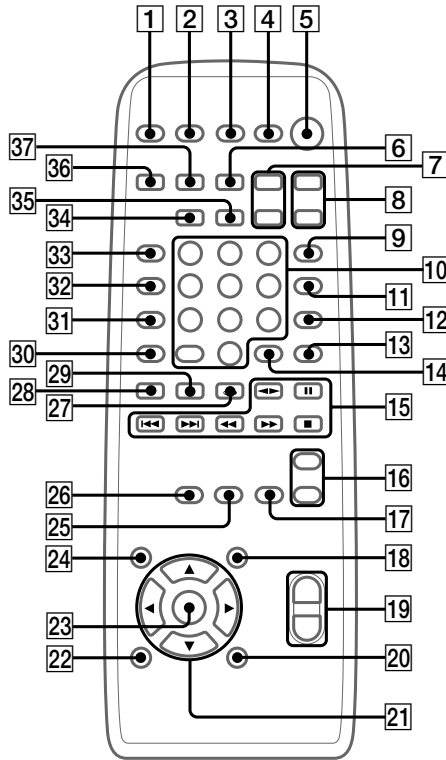

- CD **36** (10 – 13, 22, 23)
- CINEMA SPACE **25** (26)
- CLEAR **30** (12)
- CLOCK/TIMER SELECT **2**
(24, 29)
- CLOCK/TIMER SET **3** (9, 23,
28, 29)
- DISPLAY **33** (9, 14)
- D.SKIP **13** (10, 11, 13)
- EFFECT ON/OFF **17** (25, 27)
- ENTER **23** (9, 13, 14, 18, 19,
23 – 25, 28, 29, 35)
- GAME **34** (26, 30)
- GAME EQ **22** (24, 26)
- KARAOKE PON **31** (27)
- KEY CONTROL #/b **16** (27)
- MD (VIDEO) **35** (30)
- MOVIE EQ **18** (24, 25)
- MUSIC EQ **24** (24, 25)
- NEXT **29** (13, 14, 17)
- Numeric buttons **10** (14, 16, 17,
18)

- ON SCREEN **14** (15)
- P FILE **20** (25)
- PICTURE/EFFECT **26** (18)
- PRESET + **15** (19)
- PRESET - **15** (19)
- PREV **28** (13, 14, 17)
- REPEAT **11** (11)
- RETURN **27** (14)
- SELECT **15** (13, 14)
- SLEEP **1** (28)
- SPECIAL MENU **12** (16, 17)
- SPECTRUM **32** (26)
- TAPE A/B **6** (20, 22)
- TUNER/BAND **37** (19, 22)
- TUNING + **15** (19, 20)
- TUNING - **15** (19, 20)
- TV I/⏻ **4** (8)
- TV CH +/- **8** (8)
- TV/VIDEO **9** (8)
- TV VOL +/- **7** (8)
- VOL **19**

BUTTON DESCRIPTIONS

- I/⏻ (power) **5**
- ▶▶ (fast forward) **15**
- ◀◀ (go back) **15**
- ◀▶ (go forward) **15**
- ⏸ (pause) **15**
- ▶▶ (play) **15**
- ◀◀ (rewind) **15**
- (stop) **15**
- ▲▼◀▶ **21**

Hooking up the system

Perform the following procedure **1** to **5** to hook up your system using the supplied cords and accessories.

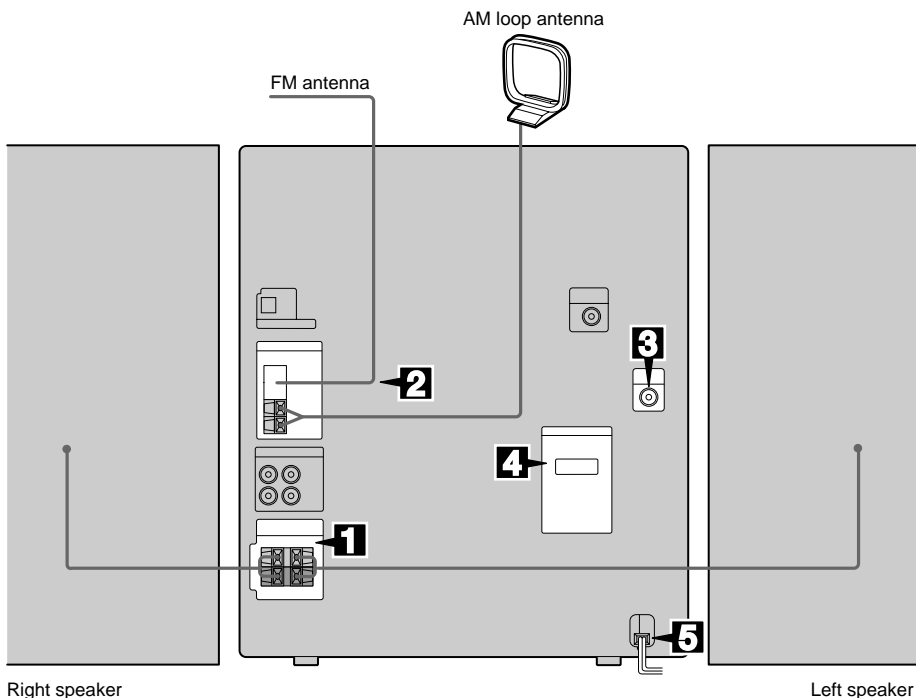

1 Connect the speakers.

Connect the speaker cords to the SPEAKER jacks as shown below.

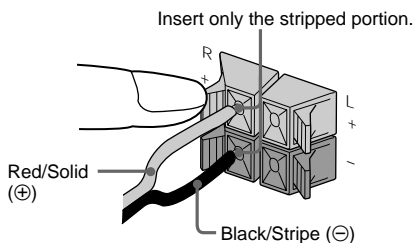

2 Connect the FM/AM antennas.

Set up the AM loop antenna, then connect it.

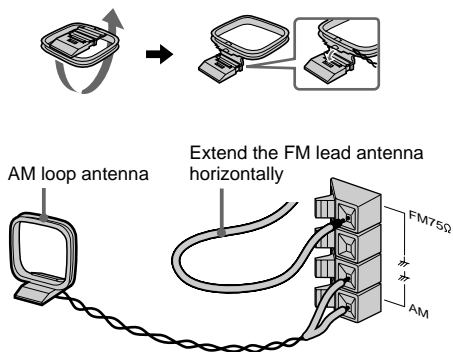

3 Connect the video input jack of your TV to the VIDEO OUT jack with the supplied video cable.

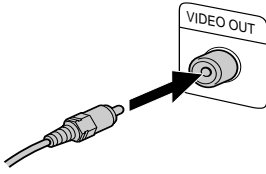

When using a TV

Turn on the TV and select the video input so you can view the pictures from this system.

Tip

For even higher quality video images, you can use an optional S-video cable to connect the S VIDEO input jack on your TV to the S VIDEO OUT jack.

4 For models with a voltage selector, set **VOLTAGE SELECTOR to the local power line voltage.**

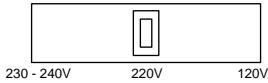

5 Connect the power cord to a wall outlet.

The demonstration appears in the display. When you press **I/⏻**, the system turns on and the demonstration automatically ends.

If the supplied adapter on the plug does not fit your wall outlet, detach it from the plug (only for models equipped with an adapter).

6 Set the color system to PAL or NTSC depending on the color system of your TV while the power is off.

The color system of your TV	Press
AUTO (factory setting)	I/⏻ while holding down III . If your TV automatically changes the color system according to the input signal, the system is set to AUTO.
NTSC	I/⏻ while holding down ▶▶I . The system is set to NTSC.
PAL	I/⏻ while holding down I◀◀ . The system is set to PAL.

Notes

- You cannot set the color system in the Power Saving Mode.
- When you play back a VIDEO CD recorded in the different color system from the one you set to the unit, the picture image may be distorted.

To connect optional components

See page 29.

continued

Hooking up the system (continued)

To attach the speaker pads

Attach the supplied speaker pads to the bottom of the speakers to stabilize the speakers and prevent them from slipping.

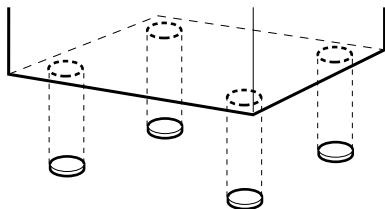

Note

Keep the speaker cords away from the antennas to prevent noise.

Using the remote

You can use the buttons shown below to operate a Sony TV.

To	Press
Turn the TV on or off	TV I/⏻.
Switch the TV's video input	TV/VIDEO.
Change the TV channels	TV CH + or -.
Adjust the volume of the TV speaker(s)	TV VOL + or -.

When carrying this system
Perform the following procedure to protect the CD mechanism.

- 1 Make sure that all discs are removed from the unit.
- 2 Hold down CD and then press I/⏻ until "STANDBY" appears.
When you release the buttons, "LOCK" appears.
- 3 Unplug the AC power cord.

Inserting two R6 (size AA) batteries into the remote

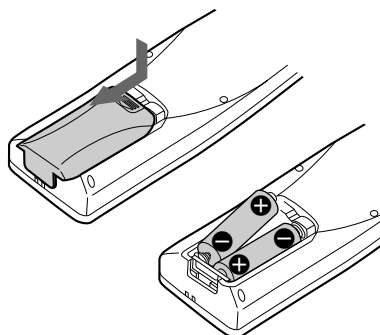

Tip

With normal use, the batteries should last for about six months. When the remote no longer operates the system, replace both batteries with new ones.

Note

If you do not use the remote for a long period of time, remove the batteries to avoid possible damage from battery leakage.

Setting the time

- 1 Turn on the system.
- 2 Press **CLOCK/TIMER SET** on the remote.
Proceed to step 5 when “CLOCK” appears in the display.
- 3 Press **▲** or **▼** repeatedly to select “**SET CLOCK**”.
- 4 Press **ENTER**.
- 5 Press **▲** or **▼** repeatedly to set the hour.
- 6 Press **▶**.
The minute indication flashes.
- 7 Press **▲** or **▼** repeatedly to set the minute.
- 8 Press **ENTER**.

Tip

If you made a mistake or want to change the time, start over from step 2.

Note

The clock settings are canceled when you disconnect the power cord or if a power failure occurs.

Saving the power in standby mode

Press **DISPLAY** repeatedly when the system is off.

Each time you press the button, the system switches cyclically as follows:

Demonstration → Clock display
→ Power Saving Mode

Tips

- I/⏻ indicator lights up even in the Power Saving Mode.
- The timer functions in the Power Saving Mode.

Note

You cannot set the time in the Power Saving Mode.

To cancel the Power Saving Mode

Press **DISPLAY** once to show the demonstration or twice to show the clock display.

Loading a CD/VIDEO CD

1 Press \blacktriangle OPEN/CLOSE.

The disc tray opens.

2 Place a CD or VIDEO CD with the label side up on the disc tray.

When you play a CD single (8 cm CD), place it on the inner circle of the tray.

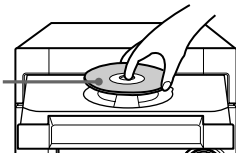

To insert additional discs, press DISC SKIP EX-CHANGE to rotate the disc tray.

3 Press \blacktriangle OPEN/CLOSE to close the disc tray.

Playing a CD

— Normal Play/Shuffle Play/Repeat Play

This system lets you play the CD in different play modes.

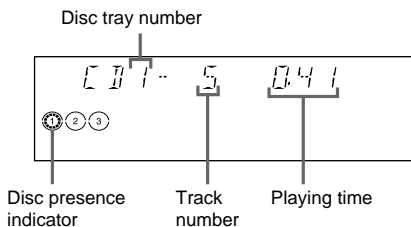

1 Press CD.

2 Press PLAY MODE repeatedly until the mode you want appears in the display.

Select	To play
ALL DISCS (Normal Play)	All CDs in the disc tray continuously.
1DISC (Normal Play)	The CD you have selected in original order.
SHUFFLE ALL DISCS (Shuffle Play)	The tracks on all CDs in random order.
SHUFFLE 1DISC (Shuffle Play)	The tracks on the CD you have selected in random order.
PROGRAM (Program Play)	The tracks on all CDs in the order you want them to be played (see "Programming CD tracks" on page 11).

3 Press $\triangleleft \triangleright$ (or $\blacktriangleleft \blacktriangleright$ on the remote).

Other Operations

To	Do this
Stop play	Press \blacksquare .
Pause	Press \mathbb{I} . Press again to resume play.
Select a track	During play or pause, press $\blacktriangleright \blacktriangleright$ (to go forward) or $\blacktriangleleft \blacktriangleleft$ (to go back).
Find a point in a track	During play, press $\blacktriangleright \blacktriangleright$ (to go forward) or $\blacktriangleleft \blacktriangleleft$ (to go back). At the desired point, press $\triangleleft \triangleright$ (or $\blacktriangleleft \blacktriangleright$ on the remote) to stop searching and start playback.
Select a CD in stop mode	Press DISC 1 – 3 or DISC SKIP EX-CHANGE (or D.SKIP on the remote).

To	Do this
Switch to CD function from another source	Press DISC 1 – 3 (Automatic Source Selection). However, if a CD is used in a program, play does not start even if you press CD 1 – 3.
Remove a CD	Press ▲ OPEN/CLOSE.
Exchange other CDs while playing	Press DISC SKIP EX-CHANGE.
Play repeatedly (Repeat Play)	Press REPEAT during play until “REPEAT” or “REPEAT 1” appears. REPEAT* ¹ : For all the tracks on the CD up to five times. REPEAT 1* ² : For a single track only. To cancel playing repeatedly, press REPEAT until “REPEAT” or “REPEAT 1” disappears.

*¹ You cannot select “REPEAT” and “SHUFFLE ALL DISCS” at the same time.

*² When you select “REPEAT 1”, that track is repeated endlessly until REPEAT 1 is canceled.

Playing a track by entering the track number

Press the number button(s) on the remote to enter the track number of the track you want to play.

To enter a track number over 10

1 Press >10.

2 Enter the corresponding digits.

To enter 0, press 10/0 instead.

Example:

To play track number 30, press >10, then 3 and 10/0.

Programing CD tracks

— Program Play

You can make a program of up to 32 tracks from all the CDs in the order you want to play them.

- 1 Press CD, then place a CD.**
- 2 Press PLAY MODE repeatedly until “PROGRAM” appears in the display.**
- 3 Press one of DISC 1 – 3 to select a CD.**
To program all the tracks on a CD at once, proceed to step 5 with “AL” displayed.
- 4 Press **◀◀** or **▶▶** until the desired track appears in the display.**

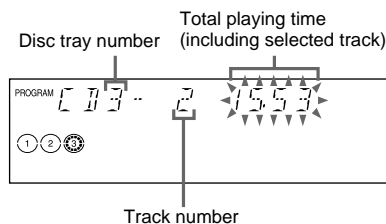

- 5 Press ENTER.**

The track is programmed. The program step number appears, followed by the total playing time.

- 6 Program additional discs or tracks.**

To program	Repeat steps
Other discs	3 and 5
Other tracks on the same disc	4 and 5
Other tracks on other discs	3 to 5

continued

Programing CD tracks (continued)

7 Press ◀▶ (or ◀▶ on the remote).

Other operations

To	Do this
Cancel Program Play	Press PLAY MODE repeatedly until "PROGRAM" and "SHUFFLE" disappear.
Clear a track from the end	Press CLEAR on the remote in stop mode.
Clear the entire program	Press ■ once in stop mode or twice during play.

Tips

- The program you made remains after Program Play finishes. To play the same program again, press CD, then press ◀▶.
- "--.--" appears when the total CD program time exceeds 100 minutes, or when you select a CD track whose number is 21 or over.

Playing a VIDEO CD

— Normal Play/Shuffle Play/Repeat Play

You can play both VIDEO CDs without PBC functions (Ver 1.1) and VIDEO CDs with PBC functions (Ver. 2.0).

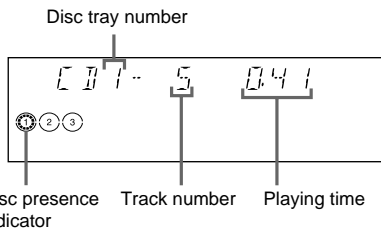

1 Turn on your TV and select the video input.

Refer to the operating instructions supplied with your TV if you need help.

2 Press CD.

3 Press PLAY MODE repeatedly until the mode you want appears in the display.

Select	To play
ALL DISCS* ¹ (Normal Play)	All CDs in the disc tray continuously.
1DISC* ¹ (Normal Play)	The CD you have selected in original order.
SHUFFLE ALL DISCS* ² (Shuffle Play)	The tracks on all CDs in random order.
SHUFFLE 1DISC* ² (Shuffle Play)	The tracks on the CD you have selected in random order.
PROGRAM (Program Play)	The tracks on all CDs in the order you want them to be played (see "Programing CD tracks" on page 11).

*¹ Only for VIDEO CDs with PBC functions (Ver.2.0), "PBC" appears while the PBC function is set to on.

*² Shuffle Play does not function during menu playback of a VIDEO CD with PBC functions (Ver. 2.0).

4 Press ◀▶ (or ◀▶ on the remote).

Other Operations

To	Do this
Stop play	Press ■.
Pause	Press ■* ¹ . Press again to resume playback.
Select a track or scene* ²	Press NEXT on the remote or ▶▶ to go forward, PREV on the remote or ◀◀ to go back. When you play VIDEO CDs with PBC functions (Ver 2.0), see pages 13 and 14).
Find a point in a track or scene (Lock Search function)	<p>① Press and hold down ◀◀ or ▶▶ during playback. According to the length of holding down the button, speed changes as follows: 1 (slow) → 2 (normal) → 3 (high) Release ◀◀ or ▶▶ at the desired speed and the search goes on at the speed.</p> <p>② Press ◀◀ or ▶▶ during playback. Each time you press the button, speed changes cyclically as follows: 1 (slow) → 2 (normal) → 3 (high) At the desired point, press ◀▶ (or ◀▶ on the remote) to stop searching and start playback.</p>
Select a VIDEO CD in stop mode	Press DISC 1 – 3 or DISC SKIP EX-CHANGE (or D.SKIP on the remote).
Remove the VIDEO CD	Press ▲ OPEN/CLOSE.
Exchange other VIDEO CDs while playing	Press DISC SKIP EX-CHANGE.
Play repeatedly (Repeat Play)	See page 11.

*¹ There may be some disturbance in the video image.

*² Only when setting the PBC function to off or when playing VIDEO CDs without PBC functions (Ver. 1.1).

Playing a VIDEO CD with PBC functions (Ver. 2.0)

— PBC Play

You can use menus on your TV screen to enjoy the disc's interactive software.

The menu format and structure will differ with each disc.

1 Press CD.

2 Press ◀▶ (or ◀▶ on the remote) to start playing a VIDEO CD with PBC functions (Ver. 2.0).

The VIDEO CD and PBC indicators light up and a PBC menu appears on your TV.

- VCD: Lights during playback of a VIDEO CD.
- PBC: Lights during PBC playback of a PBC compatible VIDEO CD (Ver. 2.0).
- PBC OFF: Lights when a PBC compatible VIDEO CD (Ver. 2.0) is played without using the PBC functions (see page 14).

3 Press ◀◀ or ▶▶ repeatedly to select a number from the menu, then press ENTER or SELECT.

4 Continue according to the instructions on the menus to enjoy interactive playback.

continued

Playing a VIDEO CD with PBC functions (Ver. 2.0) (continued)

To	Do this
Stop play	Press ■ .
See the rest of a menu	Press NEXT on the remote.
Go back to the top of a menu	Press PREV on the remote.
Go back to a previous menu	Press RETURN  on the remote.
Cancel playback with PBC functions (Ver. 2.0)	In stop mode, press ◀◀ or ▶▶ to select the desired track, then press ENTER or SELECT on the remote. Also you can select the desired track number using the numeric buttons on the remote. The PBC OFF indicator lights up and playback begins from the selected track. Still images, such as the menu screens, will not be shown.
Select a menu number using the remote	Press the numeric buttons (see "To enter a track number over 10" on page 11).

Tip

When  appears on the TV screen, you have pressed an invalid button.

Using the CD display

You can check the remaining time of the current track or the entire CD.

Press DISPLAY repeatedly.

The display changes cyclically as follows:

During normal play

Playing time of the current track → Remaining time of the current track → Remaining time of the current CD (1DISC mode) or "--.--" display (ALL DISCS mode) → Clock display (for eight seconds) → Effect status

(VIDEO CDs with PBC functions (Ver. 2.0))

Playing time on the current track* → Clock display (for eight seconds) → Effect status

* May not appear with still images, etc.

In stop mode

Total number of tracks and total playing time

→ Clock display (for eight seconds)

→ Effect status

Using the on-screen display

You can check the current operating status and disc information of VIDEO CDs or audio CDs during playback or in stop mode. **Depending on conditions, some items are displayed and others are not.**

Press ON SCREEN on the remote.

Each time you press this button, the on-screen display changes cyclically as follows:

ON SCREEN 1 → ON SCREEN 2 → ON SCREEN OFF*

* No display (except for Time Search/Disc Digest/Track Digest)

ON SCREEN display 1, 2

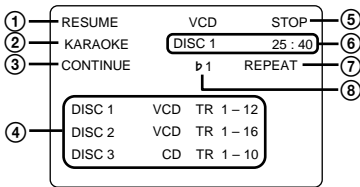

①

While the deck is:	Displayed
In stop mode	“RESUME” or no display
During playback	Current disc and track number* ¹

*¹ For VIDEO CD, only ON SCREEN 2 displays the current disc and track number during playback. “SCENE” and the number is displayed during playback of a VIDEO CD with PBC functions.

② KARAOKE effect status

③ Play mode or “AUTO PBC”^{*2}

*² “AUTO PBC” appears for a VIDEO CD with PBC functions.

④

While the deck is:	Displayed
In Program Play mode	Programed disc and track number
In stop mode (ON SCREEN 2 only)	Disc number and track numbers
In other conditions	No display

⑤

While the deck is:	Displayed
In stop mode	STOP
During playback	Elapsed time of current track

⑥

While the deck is:	Displayed
In stop mode	Current disc number and total playing time of the current disc ^{*3}
During playback	No display

*³ In Program Play mode, total playing time of the program appears.

⑦ “REPEAT”, “REPEAT 1” or no display

⑧ Key control level or no display

Note

Check to make sure that ON SCREEN OFF is selected when recording a video signal played back by this system onto a video tape, etc. Otherwise the display information will also be recorded onto the video tape.

Locating a specific part of a disc

— *Time Search/Disc Digest/Track Digest*

The TV screen must be ON to use these functions. These functions cannot be used during playback of VIDEO CDs with PBC functions (Ver. 2.0). Use the remote.

To stop playback

Press ■.

To enter 10 or over with the numeric buttons

Press the numeric buttons on the remote (see “To enter a track number over 10” on page 11).

To use VIDEO CDs with PBC functions (Ver. 2.0)

See pages 13 and 14.

Locating by elapsed time from the beginning of the disc

— *Time Search*

- 1 Press **SPECIAL MENU** on the remote.
- 2 Press **1** on the remote to select “1) TIME SEARCH.”
- 3 Press the numeric buttons (**1 – 10/0**) on the remote to enter the time (in minutes) for the section you want.
To enter 10 minutes: Press **1** → **10/0**.
The selected elapsed time appears on the TV screen.
To reenter the time: Press **CLEAR**, and then press the numeric buttons again.
- 4 Press **◀▶** (or **◀▶** on the remote).
Playback starts from the selected time.

Locating the track you want

— *Disc Digest*

You can select the track you want by viewing the first frame of each track. 9 different tracks can be displayed on the TV screen at one time.

1 Press SPECIAL MENU on the remote.

2 Press 2 on the remote to select “2) DISC DIGEST”.

The first frame of tracks 1 through 9 on the current disc are displayed.

The sound of the first three seconds of each track on an audio CD plays, but there is no sound when using a VIDEO CD.

3 Press the numeric buttons (1 – 10/0) on the remote to select the track you want.

To display the next 9 tracks

Press NEXT on the remote. The first frame of tracks 10 through 18 are displayed.

When there are more tracks in the disc, “▶▶▶” appears in the upper right corner of the TV screen.

To display previous tracks, press PREV on the remote.

To switch to the digest of another disc during Disc Digest

Press D.SKIP during Disc Digest.

Note

The play mode automatically switches to CONTINUE mode if you start Disc Digest during Shuffle or Program Play.

Locating a section within a track

— *Track Digest*

You can have the CD player divide a VIDEO CD track into 9 different sections and display the first scene of each section on the TV screen.

1 Press SPECIAL MENU on the remote.

2 Press 3 on the remote to select “3) TRACK DIGEST”.

The current track is divided into 9 sections and the first frame of each section is displayed.

The sound of the first three seconds of each track on an audio CD plays, but there is no sound when using a VIDEO CD.

3 Press the numeric buttons (1 – 10/0) on the remote to select the section you want.

Playback starts from a point near the selected frame.

To switch to the digest of another track during Track Digest

Press PREV or NEXT on the remote during Track Digest.

Notes

- Tracks less than 40 seconds long may be divided into fewer than 9 sections.
- You cannot use this function during Shuffle Play or Program Play.

Resuming playback from the point you stopped a VIDEO CD

— Resume Play

The unit memorizes the point where you stopped the VIDEO CD so you can resume from that point. Resume Play is not canceled when you turn off the system.

Resume Play is not available for an audio CD.

1 While playing a VIDEO CD, press ■ to stop playback.

“RESUME” appears on your TV screen. If “RESUME” does not appear, Resume Play is not available.

2 Press ◀▶ (or ◀▶ on the remote).

The player starts playback from the point you stopped the VIDEO CD in step 1.

To view from the beginning of the VIDEO CD

When “RESUME” appears in the display, press ■, then press ◀▶ (or ◀▶ on the remote).

Notes

- Resume Play is not available in the Digest, Shuffle, or Program Play modes.
- Depending on where you stopped the VIDEO CD, the player may resume playback from a different point.
- Resume Play is canceled when:
 - you press the numeric buttons, PLAY MODE, ■, DISC SKIP EX-CHANGE (or D.SKIP on the remote), SPECIAL MENU, or ◀▶/▶▶.
 - you remove the VIDEO CD.
 - you unplug the system’s power cord.

Adjusting the picture

— Picture Effect

You can adjust the hue and sharpness of the picture.

1 Press PICTURE EFFECT during playback.

2 Press ◀ or ▶ repeatedly to adjust the hue.

3 Press ▲ or ▼ repeatedly to adjust the sharpness.

4 Press ENTER or PICTURE EFFECT.

Tip

The hue and sharpness can be adjusted in 11 steps (from -5 to +5).

Presetting radio stations

You can preset up to 20 stations for FM and 10 stations for AM.

- 1 Press **TUNER/BAND** repeatedly to select **"FM"** or **"AM"**.
- 2 Press and hold **+** or **-** (or **TUNING +** or **-** on the remote) until the frequency indication starts to change, then release it.

Scanning stops automatically when the system tunes in a station. **"TUNED"** and **"STEREO"** (for a stereo program) appear.



- 3 Press **TUNER MEMORY**.

A preset number appears in the display. The stations are stored from preset number 1.

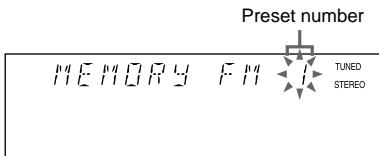

- 4 Press **ENTER**.
"COMPLETE" appears.
 The station is stored.
- 5 Repeat steps 1 to 4 to store other stations.

To tune in a station with a weak signal

Press **+** or **-** (or **TUNING +** or **-** on the remote) repeatedly in step 2 to tune in the station manually.

To set another station to an existing preset number

Start over from step 1. After step 3, press **◀◀** or **▶▶** (or **PRESET -** or **+** on the remote) repeatedly to select the preset number you want to store the other station.

You can preset a new station in the selected preset number.

To erase a preset station

- 1 Press and hold **TUNER MEMORY** until a preset number appears in the display.

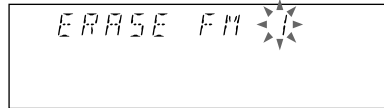

- 2 Press **◀◀** or **▶▶** (or **PRESET -** or **+** on the remote) repeatedly to select the preset number you want to erase.
 Select **"ALL ERASE"** when you want to erase all the preset stations.

- 3 Press **ENTER**.
"COMPLETE" appears.

When you erase a preset number, the preset number decreases by one and all preset numbers following the erased one are renumbered.

To change the AM tuning interval
 The AM tuning interval is factory-set to 9 kHz (10 kHz in some areas). To change the AM tuning interval, tune in any AM station first, then turn off the system. While holding down **ENTER**, turn the system back on. When you change the interval, all the AM preset stations are erased. To reset the interval, repeat the same procedure.

Tip

The preset stations are retained for half a day even if you unplug the power cord or if a power failure occurs.

Note

You cannot change the AM tuning interval in the Power Saving Mode.

Listening to the radio

— Preset Tuning

Preset radio stations in the tuner's memory first (see "Presetting radio stations" on page 19).

- 1 Press **TUNER/BAND** repeatedly to select "FM" or "AM".
- 2 Press **◀◀** or **▶▶** (or press **PRESET -** or **+** on the remote) repeatedly to tune in the desired preset station.

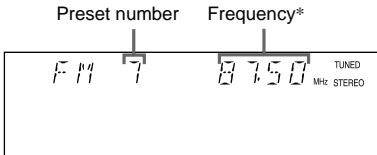

* When only one station is preset, "ONE PRESET" appears in the display.

To listen to non-preset radio stations

Use manual or automatic tuning in step 2.

For manual tuning, press **+** or **-** (or **TUNING +** or **-** on the remote) repeatedly. For automatic tuning, press and hold **+** or **-** (or **TUNING +** or **-** on the remote).

Tips

- When an FM stereo program has static noise, press **STEREO/MONO** repeatedly until "MONO" appears. There will be no stereo effect, but the reception will improve.
- To improve broadcast reception, adjust the supplied antennas.

Loading a tape

- 1 Press **TAPE A/B** repeatedly to select deck A or B.
- 2 Press **▲**.
- 3 Insert a tape in deck A or B with the side you want to play/record facing forward.

With the side you want to play/record facing forward.

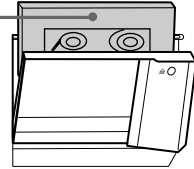

Playing a tape

You can use TYPE I (normal) tape.

1 Load a tape.

2 Press DIRECTION repeatedly to select \rightleftarrows to play one side. Select \rightleftarrows *¹ to play both sides.

To play both decks in succession, select "RELAY" (Relay Play)*².

3 Press $\triangleleft \triangleright$ (or $\blacktriangleleft \blacktriangleright$ on the remote).

Press $\triangleleft \triangleright$ (or $\blacktriangleleft \blacktriangleright$ on the remote) again to play the reverse side*¹. The tape starts playing.

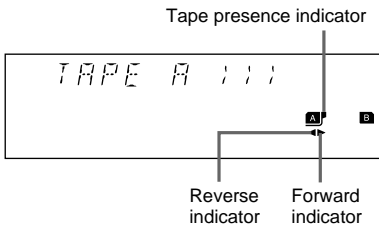

*¹ The deck stops automatically after repeating the sequence five times.

*² Relay Play always follows this cyclic sequence up to five times, then stops:

Deck A (front side) → Deck A (reverse side)
 → Deck B (front side) → Deck B (reverse side)

To	Do this
Stop play	Press ■.
Pause	Press ■■. Press again to resume play.
Fast-forward or rewind	Press ◀◀ or ▶▶.
Remove the cassette	Press ▲.

Searching for the beginning of the current or the next track (AMS)*

To go forward

Press ▶▶ during playback when ▶ lights in the display.

"TAPE A (or TAPE B) >>> +1" appears.

Press ◀◀ during playback when ◀ lights in the display.

"TAPE A (or TAPE B) <<< +1" appears.

To go back

Press ◀◀ during playback when ▶ lights in the display.

"TAPE A (or TAPE B) <<< -1" appears.

Press ▶▶ during playback when ◀ lights in the display.

"TAPE A (or TAPE B) >>> -1" appears.

* AMS (Automatic Music Sensor)

Tip

When a tape is inserted, corresponding forward/reverse indicators light.

Note

The AMS function may not operate correctly under the following circumstances:

- When the unrecorded space between songs is less than 4 seconds long.
- When the system is placed near a television.

Recording to a tape

— CD Synchro Recording/Recording Manually/Program Edit

You can record from a CD, VIDEO CD, tape or radio. You can use TYPE I (normal) tape. The recording level is adjusted automatically.

Steps	Recording from a CD/VIDEO CD (CD Synchro Recording)	Recording from a CD/VIDEO CD/tape/radio manually
1	Load a recordable tape into deck B.	
2	Press CD.	Press CD, TAPE A/B or TUNER/BAND.
3	Load the CD/VIDEO CD you want to record.	Load the CD, VIDEO CD or tape, or tune in the station you want to record.
4	Press CD SYNC. Deck B stands by for recording. REC PAUSE/START button flashes.	Press REC PAUSE/START.
5	Press DIRECTION repeatedly to select ⇌ to record on one side. Select ⇔ (or RELAY) to record on both sides.	
6	Press REC PAUSE/START.	Press REC PAUSE/START, and then start playing the desired source.

To stop recording
Press ■.

Note
You cannot listen to other sources while recording.

Tips

- If you want to record from the reverse side, press TAPE A/B to select deck B after step 1. Press ◀▶ (or ◀▶ on the remote) to start playback of the reverse side, then press ■ to start recording. The TAPE B reverse indicator lights up.
- When you record on both sides, be sure to start from the front side. If you start from the reverse side, recording stops at the end of the reverse side.
- For recording from the radio:
If noise is heard while recording from the radio, move the respective antenna to reduce the noise.

Recording a CD by specifying track order

— Program Edit

When programming, make sure the playing times for each side do not exceed the length of one side of the tape.

- 1 Load a CD and load a recordable tape into deck B.**
- 2 Press CD.**
- 3 Press PLAY MODE repeatedly until “PROGRAM” appears in the display.**
- 4 Press one of DISC 1 – 3 to select a CD.**
To program all the tracks on a CD at once, proceed to step 5 with “AL” displayed.
- 5 Press ◀◀ or ▶▶ until the desired track appears in the display.**
- 6 Press ENTER.**
The track is programmed. The program step number appears, followed by the total playing time.
- 7 To program additional tracks, repeat steps 4 to 6.**
Skip step 4 to select tracks from the same disc.
- 8 Press II to pause at the end of side A.**
- 9 Repeat steps 5 and 6 for the same disc or 4 to 6 for tracks from another disc to program the remaining tracks to be recorded on side B.**
- 10 Press CD SYNC.**
Deck B stands by to record in the direction of the indication on ◀▶ (the right indication lights to record on the forward side and the left indicator lights to record on the reverse side). The CD player stands by for playback.

11 Press DIRECTION repeatedly to select ⇌ to record on one side. Select ↔ (or RELAY) to record on both sides.

12 Press REC PAUSE/START.

Recording starts.

Tip

To check the required tape length for recording a CD, press EDIT until “EDIT” flashes after you have loaded a CD and pressed CD. The required tape length for the currently selected CD appears, followed by the total playing time for side A and side B respectively (**Tape Select Edit**).

Note

You cannot use Tape Select Edit for discs containing over 20 tracks.

Timer-recording radio programs

You can record a preset radio station from a specified time.

To timer-record, you must first preset the radio station (see “Presetting radio stations” on page 19) and set the clock (see “Setting the time” on page 9).

- 1 Tune in the preset radio station (see “Listening to the radio” on page 20).**
- 2 Press CLOCK/TIMER SET on the remote.**
“SET DAILY 1” appears.
- 3 Press ▲ or ▼ repeatedly to select “SET REC”, then press ENTER.**
“ON” appears and the hour indication flashes in the display.

continued

**Timer-recording radio programs
(continued)**

4 Set the time to start recording.

Press ▲ or ▼ repeatedly to set the hour, then press ►.

The minute indication starts flashing.

Press ▲ or ▼ repeatedly to set the minute, then press ENTER.

5 Repeat step 4 to set the time to stop recording.

The start time appears, followed by the stop time, the preset radio station to be recorded (e.g., “TUNER FM 5”), then the original display appears.

6 Load a recordable tape into deck B.

7 Press I/⏻ to turn off the system.

When the recording starts, the volume level is set to minimum.

Other Operations

To	Do this
Check the setting	Press CLOCK/TIMER SELECT on the remote and press ▲ or ▼ repeatedly to select “SEL REC”. Then, press ENTER. To change the setting, start over from step 1.
Cancel the timer	Press CLOCK/TIMER SELECT on the remote and press ▲ or ▼ repeatedly to select “TIMER OFF”, then press ENTER.

Notes

- If the system is on at the preset time, the recording will not be made.
- When you use the Sleep Timer, Daily Timer and Timer recording will not turn on the system until the Sleep Timer turns it off.

Adjusting the sound

You can reinforce the bass and create a more powerful sound.

The GROOVE setting is ideal for music sources, and the V-GROOVE setting is ideal for video sources (movies, VCDs).

Press GROOVE.

Each time you press the button, the display changes cyclically as follows:

GROOVE ON* → V-GROOVE ON*
→ GROOVE OFF

* The volume switches to power mode, the equalizer curve changes, and the “GROOVE” indicator lights up.

Selecting the sound effect

Selecting the effect from the music menu

Press MUSIC EQ, MOVIE EQ or GAME EQ repeatedly to select the preset you desire.

The preset name appears in the display. See the chart “Sound effect options”.

To cancel the effect

Press EFFECT ON/OFF repeatedly until “EFFECT OFF” appears in the display.

Sound effect options

“SURR” appears if you select an effect with surround effects.

MUSIC EQ

Effect

ROCK	Standard music sources
POP	
JAZZ	
DANCE	
SOUL	
ORIENTAL	

MOVIE EQ

Effect

ACTION	Soundtracks and special listening situations
DRAMA	
MUSICAL	

GAME EQ

Effect

ADVENTURE	PlayStation 1, 2 and other video game music sources
ARCADE	
RACING	

Adjusting the graphic equalizer and storing

You can adjust the sound by raising or lowering the levels of specific frequency ranges, then store up to three personal files (P FILE) in the memory.

Select the audio emphasis you want for your basic sound first.

- 1 Press ◀ or ▶ repeatedly to select a frequency band, then press ▲ or ▼ to adjust the level.

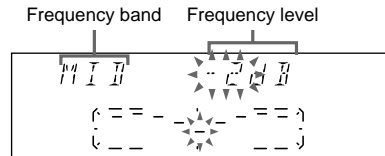

- 2 Press and hold P FILE.

A personal file number appears in the display.

- 3 Press P FILE repeatedly to select P FILE 1 – 3 where you want to store the equalizer setting.

- 4 Press ENTER.

“COMPLETE” appears.

This setting is automatically stored as the personal file you selected in step 3.

To	Press
Call up a personal file	P FILE repeatedly to select the desired personal file number.
Cancel a personal file	EFFECT ON/OFF repeatedly until “EFFECT OFF” appears in the display.

Selecting the surround effect

Press **CINEMA SPACE** on the remote repeatedly to turn the surround effect on or off.

Each time you press the button, the display changes as follows:

C.SPACE LOW* → C.SPACE MID* →
C.SPACE HIGH* → SURR ON (on) →
SURR OFF (off)

* CINEMA SPACE is the surround effect for movies.

Note

When you select other sound effects, the surround effect will be canceled.

Enhancing video game sound

— *Game Sync*

You need to connect a video game machine (see “Connecting a video game machine” on page 30).

Press **GAME**.

Tips

- In the standby mode, the system automatically turns on.
- The GAME EQ (previously selected effect) is automatically selected.
- These operations cannot be performed in the Power Saving Mode.

Changing the spectrum analyzer display

Press **SPECTRUM**.

Each time you press the button, the display changes cyclically as follows:

PATTERN 1 → PATTERN 2 → PATTERN 3 → PATTERN OFF (No display)

Singing along: Karaoke

You can sing along by turning down the singer’s voice. You need to connect an optional microphone.

- 1 Turn **MIC LEVEL** to **MIN** to turn down the microphone control level.
- 2 Connect an optional microphone to **MIC 1** or **2**.

3 Press KARAOKE PON repeatedly to obtain the karaoke effect you desire.

Each time you press the button, the display changes cyclically as follows:

KARAOKE PON → MPX R*¹ → MPX L*¹ → Effect status*²

*¹ Only for CD or VCD.

*² KARAOKE PON is canceled.

To sing karaoke of multiplex CD, select “MPX R” or “MPX L”.

4 Start playing the music.





5 Adjust the microphone volume by turning MIC LEVEL.

To	Do this
Use VIDEO CDs	Turn on your TV and switch it to the appropriate video input.
Cancel karaoke mode	Turn MIC LEVEL to MIN and disconnect the microphone from MIC 1 or 2, then press KARAOKE PON repeatedly until “KARAOKE PON”, “MPX R” or “MPX L” disappears.
Adjust the microphone echo	Turn ECHO LEVEL to adjust the echo effect. To cancel the echoing, turn ECHO LEVEL to MIN.
Adjust the key	Press KEY CONTROL # or b on the remote to suit your vocal range. You can adjust the key higher or lower in 13 half-tone steps (b6 – #6). This function cannot be used with the tape deck.

Notes

- With some songs, vocals may not be canceled when you select “KARAOKE PON”.
- During KARAOKE PON, equalizer and surround settings cannot be changed.
- If you press MUSIC EQ, MOVIE EQ, GAME EQ or EFFECT ON/OFF or recall a sound effect, the karaoke mode is canceled.
- The instrumental sound may be reduced as well as the singer’s voice when the sound is recorded in monaural.
- The singer’s voice may not be reduced when:
 - only a few instruments are playing.
 - a duet is being played.
 - the source has strong echoes or chorus.
 - the singer’s voice deviates from the center.
 - the voice on the source is singing in high soprano or tenor.

Mixing and recording sounds

- 1 Do the procedure for “Singing along” (steps 1 through 5). Then, load a recordable tape in deck B.
- 2 Press the function button of the source you want to record (e.g., CD).
When you want to record from TAPE A, press TAPE A/B repeatedly until TAPE A is selected.
- 3 Press REC PAUSE/START.
Deck B stands by for recording. The indicator on REC PAUSE/START flashes.
- 4 Press DIRECTION repeatedly to select  to record on one side. Select  (or RELAY) to record on both sides.
- 5 Press REC PAUSE/START and then press  (or  on the remote) to start playing the source to be recorded.
Start singing along with the music.

continued

Singing along: Karaoke (continued)

To stop recording

Press ■.

Tips

- If acoustic feedback (howling) occurs, move the microphone away from the speakers or change the direction of the microphone.
- If you want to record your voice through the microphone only, you can do so by selecting the CD function and not playing a CD.
- When high level sound signals are input, the system automatically adjusts the recording level to prevent distortion of the recorded sound signal (Auto Level Control function).

Falling asleep to music

— Sleep Timer

You can set the system to turn off after a certain time, so that you can fall asleep to music.

Press SLEEP on the remote.

Each time you press the button, the minute display (the turn-off time) changes cyclically as follows:

AUTO* → 90 → 80 → 70 → ... → 10 → OFF

* The system turns off when the current CD or tape finishes playback (for up to 100 minutes).

Other Operations

To	Press
Check the remaining time	SLEEP on the remote once.
Change the time to turn off	SLEEP on the remote repeatedly to select the time you want.
Cancel the Sleep Timer function	SLEEP on the remote repeatedly until "SLEEP OFF" appears.

Waking up to music

— Daily Timer

You can wake up to music at a preset time. Make sure you have set the clock (see "Setting the time" on page 9).

1 Prepare the music source you want to play.

- CD: Load a CD. To start from a specific track, make a program (see "Programing CD tracks" on page 11).
- Tape: Load a tape with the side you want to play facing forward.
- Radio: Tune in the preset station you want (see "Listening to the radio" on page 20).

2 Adjust the volume.

3 Press CLOCK/TIMER SET on the remote.

"SET DAILY 1" appears.

4 Press ▲ or ▼ repeatedly to select "DAILY 1 (or 2)", then press ENTER. "ON" appears and the hour indication flashes.

5 Set the time to start playing.

Press ▲ or ▼ repeatedly to set the hour, then press ►.

The minute indication flashes.

Press ▲ or ▼ repeatedly to set the minute, then press ENTER.

6 Repeat step 5 to set the time to stop playing.

7 Press ▲ or ▼ repeatedly until the music source you want appears.

The indication changes as follows:

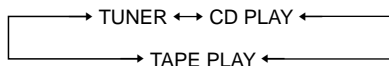

Hooking up the optional A/V components

You can connect your MD deck or VCR to this system.

8 Press ENTER.

The type of timer (“DAILY 1” or “DAILY 2”), followed by the start time, stop time, and the music source appear, then the original display appears.

9 Press I/⏻ to turn off the system.

To	Do this
Check the setting	Press CLOCK/TIMER SELECT on the remote and press ▲ or ▼ repeatedly to select the respective mode (“DAILY 1” or “DAILY 2”), then press ENTER.
Change the setting	Start over from step 1.
Cancel the timer	Press CLOCK/TIMER SELECT on the remote and press ▲ or ▼ repeatedly to select “TIMER OFF”, then press ENTER.

Tip

The system turns on 15 seconds before the preset time.

Notes

- You cannot activate DAILY 1 and DAILY 2 timer at the same time.
- When you use the Sleep Timer, the Daily Timer will not turn on the system until the Sleep Timer turns it off.
- You cannot activate the Daily Timer and Timer-recording at the same time.

To the digital input jack of the MD deck To the audio output of the MD deck or VCR

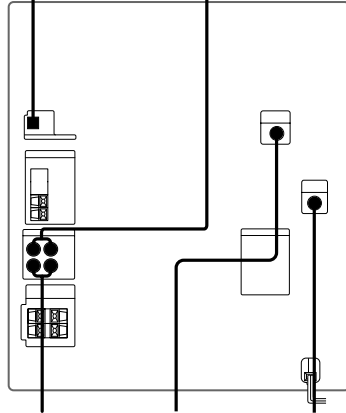

To the audio input of the MD deck or VCR

To the S VIDEO input of the VCR

To the video input of the VCR

continued

Hooking up the optional A/V components (continued)

To	Do this
Make a digital recording from a CD to an MD	Connect an optional optical cable.
Make an analog recording on an MD	Connect an optional audio cable.
Make an analog recording from a VIDEO CD to a video tape	Connect an optional audio cable from the MD/VIDEO (AUDIO) OUT jacks and the supplied video cable (or optional S VIDEO cable) from the VIDEO OUT (or S VIDEO OUT) jack to your VCR.
Listen to the connected MD deck	Press MD (VIDEO).
Listen to the connected VCR	Hold down MD (VIDEO) and press I/⏪ while the system is on. This switches the “MD” function to “VIDEO”. Once you enable the “VIDEO” function, just press MD (VIDEO).

Notes

- You cannot record from a VIDEO CD to an MD digitally. When you record from a VIDEO CD to an MD, make an analog recording on MD.
- If you cannot select “MD” when you press MD (VIDEO), press I/⏪ while holding down MD (VIDEO) when the system is on. “VIDEO” will be switched to “MD”. To return to “VIDEO”, do the same procedure.
- Make sure to match the color of the plugs and the connectors.
- When you connect a VIDEO CD deck, set to “MD”.

Connecting a video game machine

Connect the video output of the video game machine to the VIDEO jack, and the audio output to the AUDIO jacks on the front panel of the system. Connect the VIDEO OUT jack on the rear panel of the system to the video input of a TV using the optional video cable.

To listen to the sound of the connected video game machine, press GAME.

To the video output of the video game machine

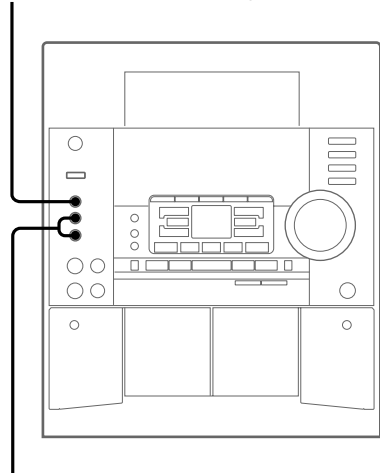

To the audio output of the video game machine

Precautions

To the video input of a TV

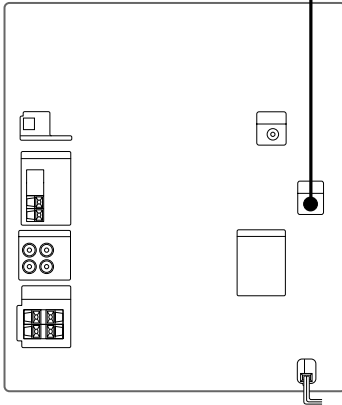

Notes

- The video game machine image may appear on the TV screen even if the system is turned off.
- See “Selecting the sound effect” on page 24 for video game sound effects.
- If you press GAME while the system is off, the system turns on, the function switches to GAME, and the equalizer also switches to the GAME EQ (previously selected effect).
- If you press GAME while the system is on, the function switches to GAME and the equalizer automatically switches to the GAME EQ (previously selected effect).

On operating voltage

Before operating the system, check that the operating voltage of your system is identical with the voltage of your local power supply.

On safety

- The unit is not disconnected from the AC power source (mains) as long as it is connected to the wall outlet, even if the unit itself has been turned off.
- Unplug the system from the wall outlet (mains) if it is not to be used for an extended period of time. To disconnect the cord (mains lead), pull it out by the plug. Never pull the cord itself.
- Should any solid object or liquid fall into the component, unplug the system and have it checked by qualified personnel before operating it any further.
- The AC power cord must be changed only at a qualified service shop.

On placement

- Place the system in a location with adequate ventilation to prevent heat build up.
- Do not place the system in an inclined position.
- Do not place the system in locations where it is:
 - Extremely hot or cold
 - Dusty or dirty
 - Very humid
 - Subject to vibrations
 - Subject to direct sunlight.

On heat buildup

- Although the unit heats up during operation, this is not a malfunction.
- Place the unit in a location with adequate ventilation to prevent heat build-up in the unit.

If you continuously use this unit at a large volume, the cabinet temperature of the top, side and bottom rises considerably. To avoid burning yourself, do not touch the cabinet.

To prevent a malfunction, do not cover the ventilation hole for the cooling fan.

continued

Precautions (continued)

On operation

- If the system is brought directly from a cold to a warm location, or is placed in a very damp room, moisture may condense on the lens inside the CD player. Should this occur, the system will not operate properly. Remove the CD and leave the system turned on for about an hour until the moisture evaporates.
- When you move the system, take out any discs.

If you have any questions or problems concerning your stereo system, please consult your nearest Sony dealer.

Notes on CDs

- Before playing, clean the CD with a cleaning cloth. Wipe the CD from the center out.
- Do not use solvents.
- Do not expose the CD to direct sunlight or heat sources.
- Discs with non-standard shapes (e.g., heart, square, star) cannot be played on this system. Attempting to do so may damage the system. Do not use such discs.

Note on CD-R playback

Discs recorded on CD-R drives may not be played back because of scratches, dirt, recording condition or the drive's characteristics. Besides, the discs, which are not yet finalized at the end of recording, cannot be played back.

Cleaning the cabinet

Use a soft cloth slightly moistened with mild detergent solution.

To save a tape permanently

To prevent a tape from being accidentally recorded over, break off the cassette tab from side A or B as illustrated. If you later want to reuse the tape for recording, cover the broken tab with adhesive tape.

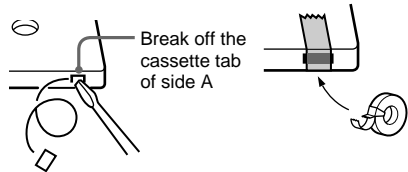
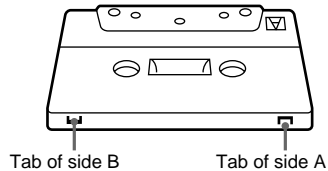

Before placing a cassette in the tape deck

Take up any slack in the tape. Otherwise the tape may get entangled in the parts of the tape deck and become damaged.

When using a tape longer than 90 minutes

The tape is very elastic. Do not change the tape operations such as play, stop, and fast-winding frequently. The tape may get entangled in the tape deck.

Cleaning the tape heads

Clean the tape heads after every 10 hours of use. Be sure to clean the tape heads before you start an important recording or after playing an old tape. Use a separately sold dry-type or wet-type cleaning cassette. For details, refer to the instructions of the cleaning cassette.

Demagnetizing the tape heads

Demagnetize the tape heads and the metal parts that have contact with the tape every 20 to 30 hours of use with a separately sold demagnetizing cassette. For details, refer to the instructions of the demagnetizing cassette.

Troubleshooting

If you have any problem using this system, use the following check list.

First, check that the power cord is connected firmly and the speakers are connected correctly and firmly.

Should any problem persist, consult your nearest Sony dealer.

General

The display starts flashing as soon as you plug in the power cord even though you haven't turned on the system (see step 5 of "Hooking up the system" on page 7).

- Press DISPLAY when the system is turned off. The demonstration disappears.

The clock setting/radio presetting/timer is canceled.

- The power cord is disconnected or a power failure occurs longer than half a day. Redo the following:

— "Setting the time" on page 9

— "Presetting radio stations" on page 19

If you have set the timer, also redo "Waking up to music" on page 28 and "Timer-recording radio programs" on page 23.

There is no sound.

- Turn VOLUME clockwise (or press VOL + on the remote).
- The headphones are connected.
- Insert only the stripped portion of the speaker cord into the SPEAKER jack. Inserting the vinyl portion of the speaker cord will obstruct the speaker connections.
- There is no audio output during timer recording.

There is severe hum or noise.

- A TV or VCR is placed too close to the stereo system. Move the stereo system away from the TV or VCR.

The sound from the connected source is distorted.

- If "VIDEO" appears in the display when you press MD (VIDEO), switch the display to "MD" (see "Hooking up the optional A/V components" on page 29).

"0:00" (or "12:00 AM") flashes in the display.

- A power interruption occurred. Set the clock and timer settings again.

The timer does not function.

- Set the clock correctly.

"DAILY 1", "DAILY 2", and "REC" do not appear when you press CLOCK/TIMER SET.

- Set the timer correctly.
- Set the clock.

The remote does not function.

- There is an obstacle between the remote and the system.
- The remote is not pointing in the direction of the system's sensor.
- The batteries have run down. Replace the batteries.

There is acoustic feedback.

- Reduce the volume.
- Move the microphone away from the speakers or change the direction of the microphone.

The color irregularity on a TV screen persists.

- Turn off the TV set once, then turn it on after 15 to 30 minutes. If the color irregularity still persists, place the speakers farther away from the TV set.

"PROTECT" and "PUSH POWER" appear alternately.

- A strong signal was input. Press I/⏻ to turn off the system, leave the system turned off for a while, then press I/⏻ again to turn on the system. If "PROTECT" and "PUSH POWER" appear alternately even after the system is turned on again, press I/⏻ to turn off the system and check the speaker cord.

continued

Troubleshooting (continued)

Speakers

Sound comes from one channel or unbalanced left and right volume.

- Check the speaker connection and speaker placement.

Sound lacks bass.

- Check that the speaker's + and – jacks are connected correctly.
-

CD/VIDEO CD Player

There is no picture.

- Check that the player is connected securely.
- Make sure you operate the TV correctly.
- Make sure you set the color system correctly, according to your TV (color) system.
- Press CD.

The CD tray does not close.

- The CD is not placed properly.

The CD will not play.

- The CD is not lying flat in the disc tray.
- The CD is dirty.
- The CD is loaded label side down.
- There is moisture on the CD.

Play does not start from the first track.

- The player is in program or shuffle mode. Press PLAY MODE repeatedly until "PROGRAM" or "SHUFFLE" disappears.
-

Tape Deck

The tape does not record.

- No tape in the cassette holder.
- The tab has been removed from the cassette (see "To save a tape permanently" on page 32).
- The tape has reeled to the end.

The tape does not record nor play or there is a decrease in sound level.

- The heads are dirty (see "Cleaning the tape heads" on page 32).
- The record/playback heads are magnetized (see "Demagnetizing the tape heads" on page 32).

The tape does not erase completely.

- The record/playback heads are magnetized (see "Demagnetizing the tape heads" on page 32).

There is excessive wow or flutter, or the sound drops out.

- The capstans or pinch rollers are dirty (see "Cleaning the tape heads" on page 32).

Noise increases or the high frequencies are erased.

- The record/playback heads are magnetized (see "Demagnetizing the tape heads" on page 32).
-

Tuner

There is severe hum or noise ("TUNED" or "STEREO" flashes in the display).

- Adjust the antenna.
- The signal strength is too weak. Connect the external antenna.

A stereo FM program cannot be received in stereo.

- Press STEREO/MONO so that "STEREO" appears.
-

If other troubles not described above occur, reset the system as follows:

- 1 Unplug the power cord.
- 2 Plug the power cord back in.
- 3 Press **■**, **ENTER**, and **I/⏻** at the same time.
- 4 Press **I/⏻** to turn on the system.

The system is reset to the factory settings. All the settings you made are cleared.

Messages

One of the following messages may appear or flash in the display during operation.

NO DISC

- There is no CD on the disc tray.

OVER

- You have reached the end of the CD.

Specifications

Amplifier section

MHC-VX333

The following measured at AC 120, 220, 240 V
50/60 Hz

DIN power output (rated) 100 + 100 watts
(6 ohms at 1 kHz, DIN)

Continuous RMS power output (reference)
120 + 120 watts (6 ohms
at 1 kHz, 10% THD)

Inputs

MD/VIDEO (AUDIO) IN (phono jacks):
voltage 450/250 mV,
impedance 47 kilohms

GAME (AUDIO) IN (phono jack):
voltage 450 mV,
impedance 47 kilohms

MIC 1/2 (mini jack):
sensitivity 1 mV,
impedance 10 kilohms

Outputs

MD/VIDEO (AUDIO) OUT (phono jacks):
voltage 250 mV
impedance 1 kilohms

VIDEO OUT (phono jack):
max. output level
1Vp-p, unbalanced, Sync
negative, load impedance
75 ohms

S-VIDEO OUT (4-pin/mini-DIN jack):
Y: 1Vp-p, unbalanced,
Sync negative,
C: 0.286Vp-p,
load impedance 75 ohms

PHONES (stereo mini jack):
accepts headphones of
8 ohms or more

SPEAKER:
accepts impedance of 6 to
16 ohms

continued

Specification (continued)

CD/VIDEO CD player section

System	Compact disc and digital audio and video system
Laser	Semiconductor laser ($\lambda=780$ nm) Emission duration: continuous
Wavelength	780 – 790 nm
Frequency response	2 Hz – 20 kHz (± 0.5 dB)
Signal-to-noise ratio	More than 90 dB
Dynamic range	More than 90 dB
Video color system format	NTSC, PAL

CD OPTICAL DIGITAL OUT

(Square optical connector jack, rear panel)	
Wavelength	660 nm
Output Level	-18 dBm

Tape deck section

Recording system	4-track 2-channel stereo
Frequency response	40 – 13,000 Hz (± 3 dB), using Sony TYPE I cassette
Wow and flutter	$\pm 0.15\%$ W.Peak (IEC) 0.1% W.RMS (NAB) $\pm 0.2\%$ W.Peak (DIN)

Tuner section

FM stereo, FM/AM superheterodyne tuner

FM tuner section

Tuning range	
Tourist model:	76.0 – 108.0 MHz
Other models:	87.5 – 108.0 MHz
Antenna	FM lead antenna
Antenna terminals	75 ohm unbalanced
Intermediate frequency	10.7 MHz

AM tuner section

Tuning range

Middle Eastern and Philippine models:

	531 – 1,602 kHz (with the interval set at 9 kHz)
Other models:	531 – 1,602 kHz (with the interval set at 9 kHz) 530 – 1,710 kHz (with the interval set at 10 kHz)
Antenna	AM loop antenna
Antenna terminals	External antenna terminal
Intermediate frequency	450 kHz

Speaker

SS-VX333 for MHC-VX333

Speaker system	3-way, 3-unit, bass-reflex type
Speaker units	
Sub Woofer:	13 cm, cone type
Woofer:	13 cm, cone type
Tweeter:	5 cm, cone type
Nominal impedance	6 ohms
Dimensions (w/h/d)	Approx. 215 × 325 × 277 mm
Mass	Approx. 4.3 kg net per speaker

General

Power requirements	
Thai model:	220 V AC, 50/60 Hz
Other models:	120 V, 220 V or 230 – 240 V AC, 50/60 Hz Adjustable with voltage selector

Power consumption	
MHC-VX333:	190 watts
Dimensions (w/h/d)	
MHC-VX333:	Approx. 280 × 325 × 421 mm
Mass	
HCD-VX333:	Approx. 10.5 kg
Supplied accessories:	AM loop antenna (1) Remote Commander (1) Batteries (2) FM lead antenna (1) Speaker pads (8) Video cable (1)

Design and specifications are subject to change without notice.

Glossary

Auto Pause

An automatical pauses according to the signal encoded on the disc while playing a VIDEO CD. If the CD player does not resume play for a long time, press ◀▶ (or ◀▶ on the remote) to resume play manually.

Menu Playback

Playback using the menu screens recorded on VIDEO CDs with PBC functions. You can enjoy simple interactive software using the menu playback function.

Playback Control (PBC)

Signals encoded on VIDEO CDs (Version 2.0) to control playback.

By using menu screens recorded on VIDEO CDs with PBC functions, you can enjoy playing simple interactive software, software with search functions, and so on.

When you select a VIDEO CD with PBC functions on this player, the PBC indicator lights up.

Track

Sections of a picture or a music piece on disc. Each track is assigned a track number to help you locate the track you want.

VIDEO CD

A compact disc which contains moving pictures.

VIDEO CDs contain compact picture information using the MPEG 1 format, one of the world wide standards of digital compact technology. The picture information is compressed about 120 times. Consequently, a 12 cm VIDEO CD can contain up to 74 minutes of moving pictures.

VIDEO CDs also contain compact audio information. Sounds outside the range of human hearing are compressed while the sounds we can hear are not compressed. VIDEO CDs can hold six times the audio information of conventional audio CDs.

There are two versions for VIDEO CDs:

Version 1.1 (VIDEO CDs without PBC functions):

You can play only moving pictures and sounds.

Version 2.0 (VIDEO CDs with PBC functions):

You can play still pictures and enjoy PBC functions.

This player can play both versions.

