

MiniDisc Deck

Operating Instructions



MDLP

MDS-PC3

WARNING

To prevent fire or shock hazard, do not expose the unit to rain or moisture.

Do not install the appliance in a confined space, such as a bookcase or built-in cabinet.

This appliance is classified as a CLASS 1 LASER product.

The CLASS 1 LASER PRODUCT MARKING is located on the bottom exterior.

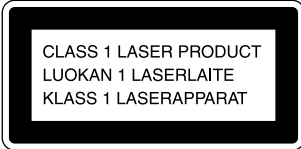

The following caution label is located inside the unit.



IN NO EVENT SHALL SELLER BE LIABLE FOR ANY DIRECT, INCIDENTAL OR CONSEQUENTIAL DAMAGES OF ANY NATURE, OR LOSSES OR EXPENSES RESULTING FROM ANY DEFECTIVE PRODUCT OR THE USE OF ANY PRODUCT.

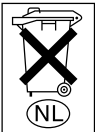

Don't throw a battery, dispose it as the injurious wastes.

For the customers in the U.S.A.

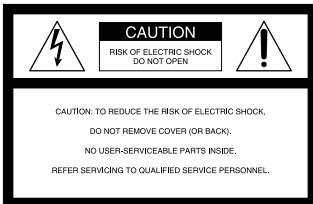

This symbol is intended to alert the user to the presence of uninsulated "dangerous voltage" within the product's enclosure that may be of sufficient magnitude to constitute a risk of electric shock to persons.



This symbol is intended to alert the user to the presence of important operating and maintenance (servicing) instructions in the literature accompanying the appliance.

If you have any questions about this product, you may call:

Sony Customer Information Services Center 1-800-222-7669

2

The number below is for the FCC related matters only.

Regulatory Information

Declaration of Conformity

Trade name: SONY

Model No.: CAV-MN10

Responsible Party: Sony Electronics Inc.

Address: 1 Sony Drive, Park Ridge, NJ. 07656 USA

Telephone No.: 201-930-6972

This device complies with Part 15 of the FCC Rules. Operation is subject to the following two conditions: (1) This device may not cause harmful interference, and (2) this device must accept any interference received, including interference that may cause undesired operation.

INFORMATION

This equipment has been tested and found to comply with the limits for a Class B digital device, pursuant to Part 15 of the FCC Rules. These limits are designed to provide reasonable protection against harmful interference in a residential installation. This equipment generates, uses, and can radiate radio frequency energy and, if not installed and used in accordance with the instructions, may cause harmful interference to radio communications. However, there is no guarantee that interference will not occur in a particular installation. If this equipment does cause harmful interference to radio or television reception, which can be determined by turning the equipment off and on, the user is encouraged to try to correct the interference by one or more of the following measures:

- Reorient or relocate the receiving antenna.
- Increase the separation between the equipment and receiver.
- Connect the equipment into an outlet on a circuit different from that to which the receiver is connected.
- Consult the dealer or an experienced radio/TV technician for help.

CAUTION

You are cautioned that any changes or modification not expressly approved in this manual could void your authority to operate this equipment.

Owner's Record

The model and serial numbers are located on the bottom of the unit. Record the serial number in the space provided below. Refer to them whenever you call upon your Sony dealer regarding this product.

Model No. MDS-PC3

Serial No. _____



A#46

For the customers in Canada

CAUTION

TO PREVENT ELECTRIC SHOCK, DO NOT USE THIS POLARIZED AC PLUG WITH AN EXTENSION CORD, RECEPTACLE OR OTHER OUTLET UNLESS THE BLADES CAN BE FULLY INSERTED TO PREVENT BLADE EXPOSURE.

Welcome!

Thank you for purchasing the Sony MiniDisc Deck. Before operating the deck, please read this manual thoroughly and retain it for future reference.

About This Manual

The instructions in this manual are for the MDS-PC3 MiniDisc Deck.

Conventions

- Controls in these instructions are those on the supplied remote; these may, however, be substituted by controls on the deck that are similarly named, or, when different, appear in the instructions within parentheses.
Example: Press **■** (or **■/▲** on the deck).
-  indicates hints and tips for making the task easier.

Table of Contents

Location and Function of Parts

Front Panel Parts	
Description	4
Remote Parts	
Description	5
Using the Display	6

Getting Started

Before You Start the Hookup	8
Hooking Up	9

Recording on MDs

Notes on Recording	11
Recording on an MD	12
Adjusting the Recording Level	14
Recording for Long Times	15
Recording Tips	16
Marking Track Numbers While Recording (Track Marking)	18
Synchro-recording With the Audio Component of Your Choice (Music Synchro-recording)	20

Playing MDs

Playing an MD	21
Playing a Specific Track ..	22
Locating a Particular Point in a Track	22
Playing Tracks Repeatedly	23
Playing Tracks in Random Order (Shuffle Play)	24
Creating Your Own Program (Program Play)	25
Tips for Recording From MDs to Tape	27

Editing Recorded MDs

Erasing Tracks	29
Dividing Tracks	31
Combining Tracks	33
Moving Tracks	34
Naming Tracks or MDs ...	35
Undoing the Last Edit	38
Changing the Track Level After Recording (S.F Edit)	39

Other Functions

Fade In and Fade Out Recording/Playback	42
---	----

Additional Information

Precautions	43
Handling MDs	44
System Limitations	44
Troubleshooting	46
Specifications	47
Display Messages	48
Edit Menu Table	49
Setup Menu Table	50
Self-Diagnosis Function	51
Index	Back cover

Front Panel Parts Description

This chapter tells you about the location and function of the various buttons and controls on the front panel and the supplied remote. Further details are provided on the pages indicated in the parentheses.

It also tells you about the information that appears in the display window.

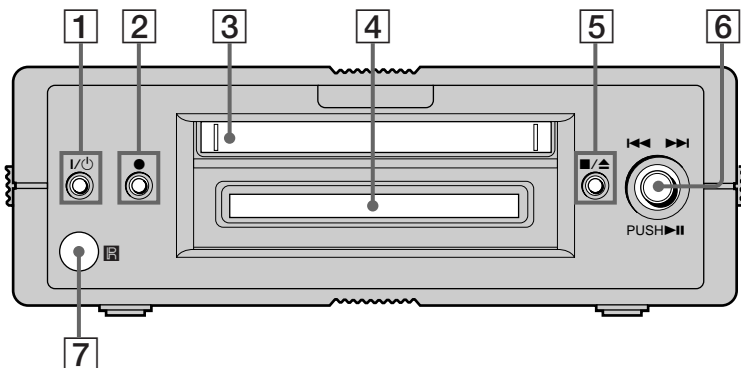

1 I/O (power) switch (12, 21)

Press to turn the deck on. When you turn the deck on, the switch indicator turns off. When you press the switch again, the deck turns off and the indicator lights up red.

2 ● button (13, 17, 18)

Press to record on the MD, monitor the input signal, or mark track numbers.

3 MD insertion slot

Insert the MD as illustrated below.

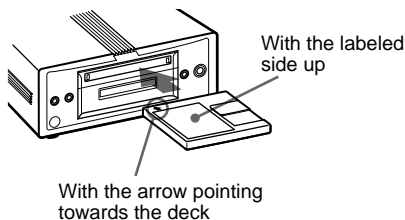

4 Display window (6, 7)

Shows various information.

5 ■/▲ button (13, 21, 29)

Press to stop play, stop recording, or cancel the selected operation.
Press to eject the MD while the deck is stopped.

6 ◀▶/▶▶ control, ▶▶▶▶ button (13, 21, 22, 25, 28)

Turn to locate tracks.
Press to start play, pause play, or pause recording.
Press to carry out the selected operation.

7 Remote sensor

Point the remote towards this window (R) for remote operations.

Remote Parts Description

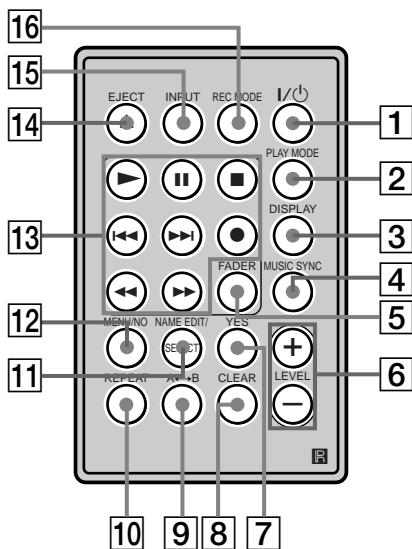

- 1 I/⏻ (power) switch (12, 21)**
Press to turn the deck on. When you turn the deck on, the I/⏻ switch indicator on the deck turns off. When you press the switch again, the deck turns off and the indicator lights up red.
- 2 PLAY MODE button (24, 25)**
Press to select Shuffle Play or Program Play.
- 3 DISPLAY button (6, 16, 25, 35)**
Press to select the information to be displayed in the window, or to select the type of characters to be input.
- 4 MUSIC SYNC button (20)**
Press to start Music Synchro-recording.
- 5 FADER button (42)**
Press to perform Fade-in Recording/Playback or Fade-out Recording/Playback.
- 6 LEVEL +/- buttons (14, 21)**
Press to adjust the recording level and the output level of the PHONES jack and ANALOG OUT jacks.
- 7 YES button (15, 25, 28)**
Press to carry out the selected operation.
- 8 CLEAR button (26, 36)**
Press to cancel the selection.

- 9 A↔B button (23)**
Press to select Repeat A-B Play.
- 10 REPEAT button (23)**
Press to play tracks repeatedly.
- 11 NAME EDIT/SELECT button (37)**
Press to add the name or change the name of a track or MD.
- 12 MENU/NO button (15, 25, 28)**
Press to display "Edit Menu" or "Setup Menu."
- 13 ▶ button (13, 21)**
Press to start play or recording.
- ⏸ button (13, 21)**
Press to pause play or recording. Press again to resume play or recording.
- button (13, 21, 29)**
Press to stop play, recording, or cancel the selected operation.
- ⏮/▶▶ buttons (13, 21, 22, 25, 28)**
Press to locate tracks, select a menu item, or select a character to be input.
- button (13, 17, 18)**
Press to record on the MD, monitor the input signal, or mark track numbers.
- ◀◀/▶▶ buttons (22, 26, 36)**
Press to locate a portion within a track, change the contents of a program, or shift the cursor.
- 14 EJECT ▲ button (13, 21)**
Press to eject the MD.
- 15 INPUT button (12)**
Press to select the input jack (or connector) of the program source to be recorded.
- 16 REC MODE button (15)**
Press to select one of the following four recording modes: Mono (monaural recording), stereo (stereo recording), LP2 (2 times normal recording time), and LP4 (4 times normal recording time).

Using the Display

The display window shows information about the MD or track. This section describes the information that appears for each deck status.

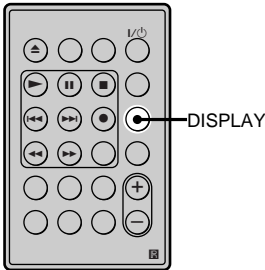

Note

The type of information (e.g., total number of tracks, recorded time, remaining time, track or disc name) which was last displayed will continue to appear until you change it by pressing DISPLAY, even if you change the deck operation status. For example, if the remaining time was displayed when you stop the deck, the remaining time will continue to appear when you begin playing the same MD again or a different one.

When you insert an MD

The display automatically changes as follows:

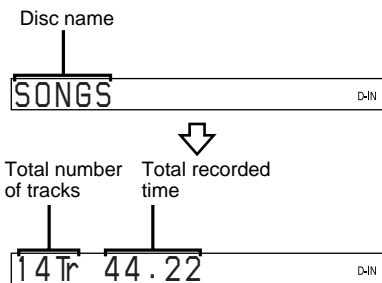

While the deck is stopped

Press DISPLAY repeatedly to change the display.

Each press of the button changes the display as follows:

Total number of tracks and total recorded time (default display)

14 Tr 44.22 D-IN

↓ Press

Remaining recordable time on the MD (recordable MDs only)*

-63.51 D-IN

↓ Press

Order of the programmed tracks**

12 → 4 → 61 PGM D-IN

↓ Press

The number and total playing time of the programmed tracks**

3 Tr 12.56 PGM D-IN

↓ Press

Disc name

SONGS D-IN

Press

* Not shown for the premastered discs.

** This display appears only when "PGM" appears.

While the deck is recording

Press **DISPLAY** repeatedly to change the display.

Each press of the button changes the display as follows:

Track number and recorded time of the current track (default display)

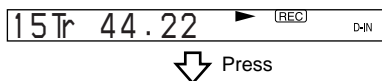

Remaining recordable time on the MD

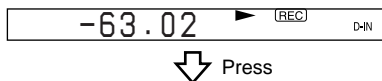

Level of the input signal

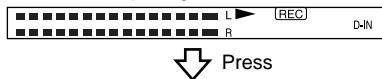

Track name

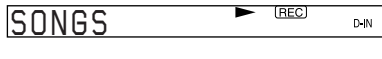

While the deck is playing

Press **DISPLAY** repeatedly to change the display.

Each press of the button changes the display as follows:

Track number and elapsed time of the current track (default display)

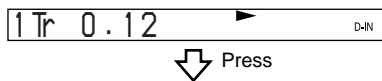

Track number and remaining time of the current track

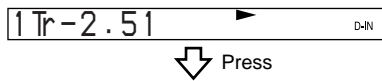

Remaining recordable time on the MD

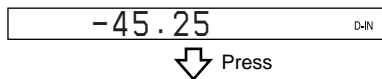

Order of the programmed tracks*

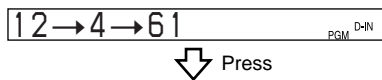

Track name

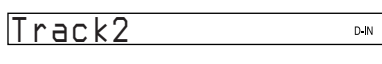

Location and Function of Parts

* The display appears only when "PGM" appears.

Before You Start the Hookup

Checking the supplied accessories

This MD deck comes with the following items:

- AC power adaptor (1)
- Audio connecting cord (stereo mini-plug × 1 ↔ stereo mini-plug × 1) (1)
- Optical cable (1)
- Remote commander (remote) RM-D52M (1)
- PC connecting kit PCLK-MN10* (1)

* Required for operation by personal computer. For details, refer to the operating instructions supplied with the PCLK-MN10.

Before using the supplied remote

The supplied remote already contains a battery. Before using the remote, pull out the insulating sheet to allow the power to flow from the battery.

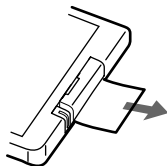

To avoid battery leakage

If you don't use the remote for an extended period of time, remove the battery to avoid possible damage from battery leakage and corrosion.

💡 When to replace the battery

Under normal conditions, the battery should last for about six months. When the remote no longer operates the deck, replace the battery with new one.

Notes on lithium battery

- Keep the lithium battery out of the reach of the children. Should the battery be swallowed, immediately consult a doctor.
- Wipe the battery with a dry cloth to assure a good contact.
- Be sure to observe the correct polarity when inserting the battery.
- Do not hold the battery with metallic tweezers, otherwise a short-circuit may occur.

WARNING

Battery may explode if mistreated.
Do not recharge, disassemble, or dispose of in fire.

Hooking Up

The MD deck can be connected to PCs with PC LINK capability (such as the VAIO-series of PCs), peripheral devices such as portable CD players, and active speakers. Make sure all devices are turned off before you hook them up.

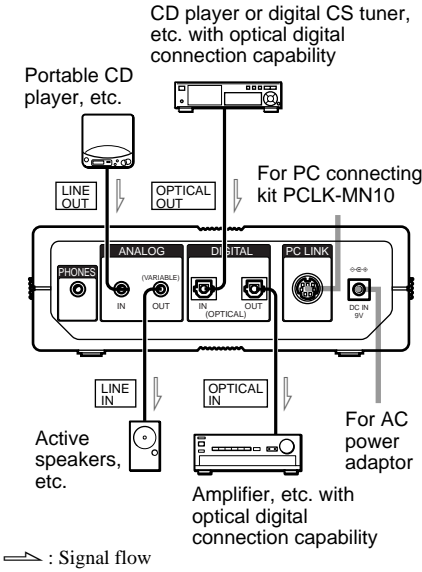

Connecting the MD deck with an audio component

The MD deck is capable of recording from both analog and digital sources.

When recording from an analog source

Required connecting cord
Audio connecting cord (supplied)

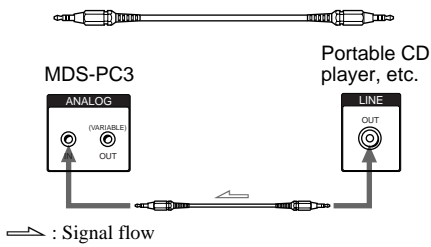

When recording from a digital source

Required connecting cord
Optical digital cable (supplied)

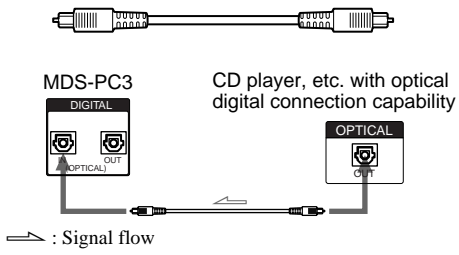

continued

Connecting the MD deck to a personal computer

Use the PCLK-MN10 PC connecting kit (supplied) to connect the PC to the MD deck through the PC LINK jack on the back of the MD deck. By connecting the MD deck to a PC, you will be able to select and play MD tracks and do various editing operations on the PC screen. For more details, refer to the manual supplied with the PC connecting kit.

Getting Started

Hooking Up (continued)

Notes

- Insert plugs into jacks firmly. Loose connections may be a cause of noise or malfunction in the MD deck.
- When connecting an optical digital cable, take the caps off the connectors and insert the cable plugs straight in the jacks until you hear a click.
When a plug is not completely inserted, “C71” and “Din Unlock” may alternate in the display.

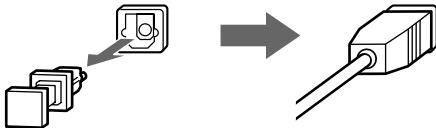

Do not bend or tie the optical cable.

Connecting the MD deck to active speakers, etc.

Required connecting cord

Audio connecting cord (stereo mini-plug × 1 ↔ stereo mini-plug × 1) (supplied) or audio connecting cord (stereo mini-plug × 1 ↔ pin-plug × 2)



or

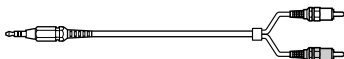

The example below shows the MD deck connected to active speakers with an audio connecting cord (stereo mini-plug × 1 ↔ stereo mini-plug × 1) (supplied).

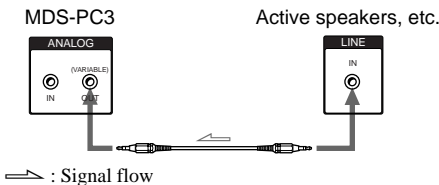



Connecting the MD deck to a system stereo or an amplifier

By connecting the MD deck to a system stereo or to an amplifier with optical digital input jacks, you can enjoy listening to MDs on the speakers connected to the system stereo or the amplifier.

Required connecting cord

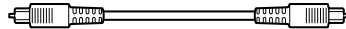
Optical digital cable (supplied)



 You can change the output level of the ANALOG OUT jacks

- 1 While the deck is stopped, press MENU/NO twice to display “Setup Menu.”
- 2 Press **◀◀/▶▶** repeatedly (or turn **◀◀/▶▶** on the deck) until “Aout” appears, then press YES (or **◀◀/▶▶** on the deck).
- 3 Press **◀◀/▶▶** repeatedly (or turn **◀◀/▶▶** on the deck) to change the output level, then press YES (or **◀◀/▶▶** on the deck).
- 4 Press MENU/NO.

You can also change the level with LEVEL +/- . In such a case, note that the output level of the PHONES jack will change with the output level of the ANALOG OUT jacks (page 21).

Connecting the AC power adaptor

Connect the AC power adaptor to the DC IN 9 V jack on the MD deck and to a wall outlet.

Notes

- Do not connect the AC power adaptor to a switched outlet.
- Use only the supplied AC power adaptor. Do not use any other AC power adaptor.



Polarity of the plug

Notes on Recording

About indications which appear while recording

When "Protected" and "C11" alternate in the display

The record-protect slot is open and the MD is record-protected. To record on the MD, slide the tab to close the slot. For details, see "To prevent accidental erasure of the recorded material" on page 13.

When "Din Unlock" and "C71" alternate in the display

- The digital component selected with INPUT is not connected correctly. Check the connection.
- The selected digital component is not turned on. Turn on the component.

When "Cannot Copy" and "C41" alternate in the display

The MD deck uses the Serial Copy Management System. MDs recorded through the digital input connector can't be copied to other MDs or DAT tapes through the digital output connector. For details, see "Guide to the Serial Copy Management System" on page 11.

When "Tr" flashes in the display

The MD deck is recording over existing track(s) ("Recording on an MD" on page 13). The indication stops flashing when the deck reaches the end of the recorded portion.

About indications which appear after recording

When "TOC" lights up in the display

Recording has finished but the TOC (Table of Contents) on the MD has not been updated to reflect the recording results. The recording will be lost if you disconnect the AC power adaptor while the indication is on. The TOC will be updated only when you eject the MD or turn off the MD deck.

When "TOC Writing" flashes in the display

The deck is updating the TOC. Do not disconnect the AC power adaptor or move the deck while the indication flashes.

Automatic conversion of digital sampling rates during recording

A built-in sampling rate converter automatically converts the sampling frequency of various digital sources to the 44.1 kHz sampling rate of the MD deck. This allows you to monitor and record sources such as 32- or 48-kHz DAT tapes or satellite broadcasts, as well as the CDs and MDs.

Please note that 22.05- or 96-kHz digital sources can't be recorded on this deck.

Guide to the Serial Copy Management System

Digital audio components, such as CDs, MDs, and DATs make it easy to produce high-quality copies of music by processing music as a digital signal.

To protect copyrighted music sources, this deck uses the Serial Copy Management System which allows you to make only a single copy of a digitally recorded source through digital-to-digital connections.

continued

You can make only a first-generation copy* through a digital-to-digital connection.

Examples are given as follows:

- You can make a copy of a commercially available digital sound program (for example, a CD or MD), but you can't make a second copy from the first-generation copy.
- You can make a copy of a digital signal from a digitally recorded analog sound program (for example, an analog record or a music cassette tape) or from a digital satellite broadcast program, but you can't make a second copy from the first-generation copy.

* A first-generation copy means the first recording of a digital audio source through the deck's digital input connector. For example, if you record from a CD player connected to the DIGITAL (OPTICAL) IN connector, that copy is a first-generation copy.

Note

The restrictions of the Serial Copy Management System don't apply when you make a recording through the analog-to-analog connections.

Recording on an MD

The operations for normal recording are explained below. If the MD has recorded material on it, the deck will automatically start recording from the end of the recorded portion.

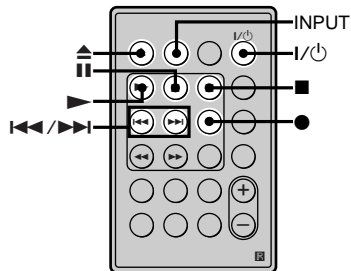

- 1 Press I/O to turn on the deck.
The switch indicator on the deck turns off.
- 2 Insert a recordable MD (page 4).
- 3 Press INPUT repeatedly to select the input jack (connector) connected to the program source.

If the source is connected Select to the

DIGITAL (OPTICAL) IN connector	Optical In
LINE (ANALOG) IN jack	Analog In

- 4 If necessary, select the recording mode.
For details, see "Recording for Long Times" on page 15.

- 5 If necessary, locate the point on the MD to start recording from.

If you want to record on a new MD or start recording from the end of the recorded portion, go to step 6.

To record over from the beginning of an existing MD track

Press **⏮/⏭** repeatedly (or turn **⏮/⏭** on the deck) until the number of the track to be recorded over appears.

To record over from the middle of an MD track

Press **⏮/⏭** repeatedly (or turn **⏮/⏭** on the deck) until the number of the track to be recorded over appears, then press **▶** (or **▶||** on the deck) to start playback. Press **||** (or **▶||** on the deck), then **●** at the point you want to start recording from.

- 6 Press **●**.

The deck changes to recording pause.

- 7 If necessary, adjust the recording level. For details, see “Adjusting the Recording Level” on page 14.

- 8 Press **▶** or **||** (or **▶||** on the deck). Recording starts.

- 9 Start playing the program source.

Operations you may want to do during recording

To	Press
Stop recording	■ (or ■/▲ on the deck)
Pause recording	 (or ▶ on the deck)
Resume recording after pausing	▶ or (or ▶ on the deck)
Eject the MD	EJECT ▲ (or ■/▲ on the deck) after stopping recording

When you pause recording

The track number increases by one. For example, if you paused recording while recording track 4, the track number will be 5 when you resume recording.

To prevent accidental erasure of the recorded material

To make it impossible to record on an MD, slide the record-protect tab in the direction of the arrow (see illustration below) to open the slot. To enable recording, close the slot.

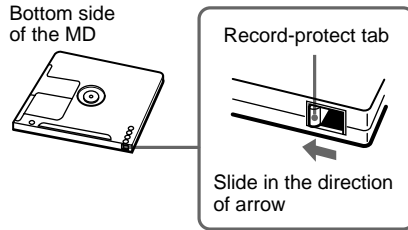

💡 To play the tracks you just recorded





Press **▶** (or **▶||** on the deck) immediately after stopping recording.

The deck starts to play from the first track of the material just recorded.

continued

Recording on an MD (continued)

 To play from the first track of the MD after recording

- 1 Press  (or  on the deck) again after stopping recording.
- 2 Press  (or  on the deck).
The deck starts to play from the first track of the MD.

Note

You can't record over existing material when Shuffle Play (page 24) or Program Play (page 25) has been selected. "Impossible" appears in the display at this time.

Adjusting the Recording Level

Do the procedure below to adjust the recording level.

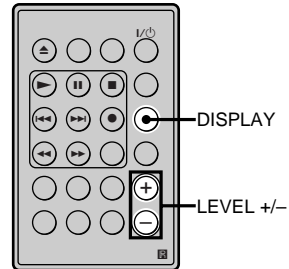

- 1 Do steps 1 to 6 of "Recording on an MD" on pages 12 and 13.
- 2 Play the portion of the program source with the strongest output.
- 3 Press DISPLAY repeatedly until the peak level meters appear.
- 4 While monitoring the sound, press LEVEL +/- repeatedly (or turn  on the deck) to adjust the recording level to its highest level without turning on the rightmost indicators on the peak level meters. Occasional lighting of the indicators is acceptable.



Make sure that those indicators do not always turn on.







- 5 Stop playing the program source.

- To start recording, continue from step 8 of “Recording on an MD” on page 13.

 You can adjust the recording level during recording or recording pause. Press LEVEL +/- repeatedly.







 To display the level of the strongest signal

The Peak Hold function continuously displays the level of the strongest signal that has been input. Do the procedure below to turn Peak Hold on.

- While the deck is stopped, press MENU/NO twice to display “Setup Menu.”
- Press  repeatedly (or turn  on the deck) until “P.Hold” appears, then press YES (or  on the deck).
- Press  (or turn  on the deck) to select “P.Hold On,” then press YES (or  on the deck).
- Press MENU/NO.

To turn Peak Hold off, select “P.Hold Off” in step 3 above.

 You can also change the input level of the ANALOG IN jacks or DIGITAL IN connector by accessing the “Setup Menu”

- While the deck is stopped, press MENU/NO twice to display “Setup Menu.”
- Press  repeatedly (or turn  on the deck) until “Ain” (for the analog input) or “Opt” (for the digital input) appears, then press YES (or  on the deck).
- Press  repeatedly (or turn  on the deck) to change the input level, then press YES (or  on the deck).
- Press MENU/NO.

Note

The maximum recording level is +18.0 dB for digital recordings, and +12.0 dB for analog recordings. The maximum recording level may still be inadequate for producing a proper recording if the output level of the source component is extremely low.

Recording for Long Times

In addition to normal stereo recording, this deck has two recording modes: LP2 and LP4. When recording in LP2 mode, you can record 2 times the normal recordable time, and in LP4 mode, you can record 4 times the normal recordable time. In addition, the recordable time for monaural recording is approximately double the stereo recording time.

Note

MDs recorded in LP2 or LP4 mode can be played back only on decks that support the MD LP format. Conventional MD decks cannot play MDs recorded in LP2 or LP4 mode.

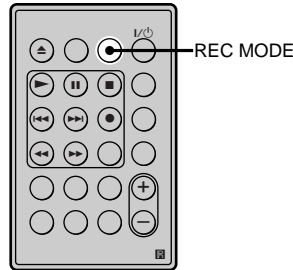

- Do steps 1 to 3 of “Recording on an MD” on page 12.
- Press REC MODE repeatedly to select the recording mode.

To record in	Select to light up
Stereo (factory setting)	no indicator
LP2 stereo	LP2
LP4 stereo	LP4
Monaural	Mono

- Do steps 5 to 9 of “Recording on an MD” on page 13.

continued

Recording for Long Times (continued)

Notes

- Even if you press REC MODE during recording or recording pause, you cannot change the recording mode.
- Even if you select the monaural recording mode, the sound from the speakers will be the same as the source sound (e.g. Stereo source sound will be as it is).

 LP Stamp function works during recording in LP2 or LP4 mode

A track recorded in LP2 or LP4 mode is given an identification code which is displayed only when you attempt to play that track on an MD deck which does not support LP modes. "LP:" appears in the display at this time. To turn off this function, do the procedure below.

- 1 While the deck is stopped or playing, press MENU/NO twice.
"Setup Menu" appears in the display.
- 2 Press **◀◀/▶▶** repeatedly (or turn **◀◀/▶▶** on the deck) until "LPstamp On" appears, then press YES (or **◀◀/▶▶** on the deck).
- 3 Press **◀◀/▶▶** (or turn **◀◀/▶▶** on the deck) to select "LPstamp Off," then press YES (or **◀◀/▶▶** on the deck).
- 4 Press MENU/NO.

To turn on the LP Stamp function again, select "LPstamp On" in step 3 above.

Notes

- "LP:" does not appear when the track is played back on the MD deck that supports the MD LP format.
- When the LP Stamp function is on, the maximum number of text characters that can be stored on the MD decreases.
- When you divide a track that was recorded with the LP Stamp function on, the "LP:" code is copied to the newly created track.

Recording Tips

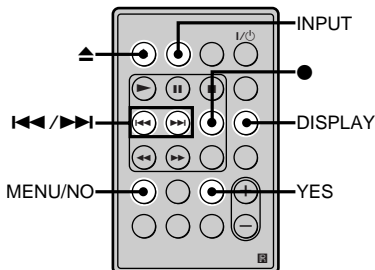

Checking the remaining recordable time on the MD



Press **DISPLAY** repeatedly.

While the deck is	The following information appears
Stopped	Total number of tracks and total recorded time → Remaining recordable time on the MD → Order of the programmed tracks → Number of the programmed tracks and total playing time the programmed tracks → Disc name
Recording	Recorded time of the current track → Remaining recordable time on the MD → Input level indication → Track name

For details, see pages 6 and 7.

Monitoring the input signal (Input Monitor)

You can monitor the selected input signal even when you're not recording it.

1 Press EJECT  (or / on the deck) to eject the MD.

2 Press INPUT repeatedly to select the jacks (connectors) which the signal you want to monitor is being input.

3 Press .

When "A-IN" is selected

The analog signal input from the LINE (ANALOG) IN jacks is output to the DIGITAL (OPTICAL) OUT connector after A/D conversion, and then to the LINE (ANALOG) OUT jacks after D/A conversion. "AD - DA" appears in the display at this time.

When "D-IN" is selected

The digital signal input from the DIGITAL (OPTICAL) IN connector first passes through the sampling rate converter, and then output to the DIGITAL (OPTICAL) OUT connector, and then to the LINE (ANALOG) OUT jacks after D/A conversion. "- DA" appears in the display at this time.

To stop monitoring the signal

Press  (or / on the deck).

Erasing blank portions automatically (Smart Space/ Auto Cut)

The deck can be set to automatically erase any blanks that are produced when the signal is interrupted during recording. The function which activates (Smart Space or Auto Cut) depends on the length of the interruption, as described below.

Smart Space







If the signal is interrupted for less than 30 seconds, Smart Space replaces the blank portion with a blank space of about three seconds, then continues the recording. "Smart Space" appears in the display during this time.







Auto Cut

If the signal is interrupted for about 30 seconds, Auto Cut replaces the blank portion with a blank space of about three seconds, then pauses the recording. "Auto Cut" appears in the display during this time.

Do the procedure below to turn Smart Space and Auto Cut on or off.

1 While the deck is stopped, press MENU/NO twice. "Setup Menu" appears in the display.

2 Press / repeatedly (or turn / on the deck) until "S.Space" appears, then press YES (or / on the deck).

3 Press / repeatedly (or turn / on the deck) to select the setting, then press YES (or / on the deck).

To	Select
Turn on Smart Space and Auto Cut	S.Space On (factory setting)
Turn off Smart Space and Auto Cut	S.Space Off

4 Press MENU/NO.

continued

Recording Tips (continued)

Notes

- If you start recording with no signal input, Smart Space and Auto Cut will not operate regardless of the setting.
- Smart Space does not affect the order of the track numbers being recorded, even if the blank space occurs in the middle of a track.
- If the deck stays in recording-pause for about 10 minutes after the Auto Cut operation, the recording operation will be automatically ended.
- Auto Cut is automatically turned on or off in tandem with Smart Space.
- If you turn off the deck or disconnect the AC power adaptor, the deck will store the last setting (“S.Space On” or “S.Space Off”) and apply it the next time you turn on the deck.

Marking Track Numbers While Recording

(Track Marking)

You can mark track numbers either manually or automatically while recording. By marking track numbers at specific points, you can quickly locate the points later or edit the MD easily.

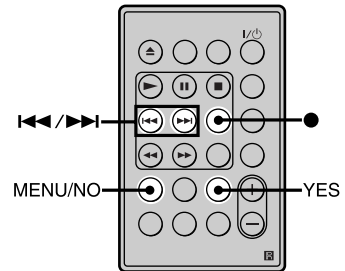

Marking track numbers manually (Manual Track Marking)

Press ● at the point where you want to add a track number while recording.

Marking track numbers automatically (Automatic Track Marking)

When recording from a CD player or MD deck connected to the DIGITAL (OPTICAL) IN connector, the deck marks track numbers in the same sequence as the source. When recording from other sources connected to the DIGITAL (OPTICAL) IN connector or a source connected to the LINE (ANALOG) IN jacks, do the procedure below to mark track numbers automatically.

- 1 While the deck is stopped, press MENU/NO twice.
“Setup Menu” appears in the display.
- 2 Press **◀◀/▶▶** repeatedly (or turn **◀◀/▶▶** on the deck) until “T.Mark” appears, then press YES (or **◀◀/▶▶** on the deck).
- 3 Press **◀◀/▶▶** (or turn **◀◀/▶▶** on the deck) to select a desired setting, then press YES (or **◀◀/▶▶** on the deck).

To	Select
Turn on Automatic Track Marking	T.Mark LSync (factory setting)
Turn off Automatic Track Marking	T.Mark Off

- 4 Press MENU/NO.
“L.SYNC” lights up.
The deck marks a track number whenever the input signal level drops to -50 dB (the trigger level for Automatic Track Marking) or below for at least 1.5 seconds and then rises over -50 dB.

To change the trigger level for Automatic Track Marking

Do the procedure below to change the signal level that triggers Automatic Track Marking.

- 1 While the deck is stopped, press MENU/NO twice.
“Setup Menu” appears in the display.
- 2 Press **◀◀/▶▶** repeatedly (or turn **◀◀/▶▶** on the deck) until “LS(T)” appears, then press YES (or **◀◀/▶▶** on the deck).
- 3 Press **◀◀/▶▶** repeatedly (or turn **◀◀/▶▶** on the deck) to select the level, then press YES (or **◀◀/▶▶** on the deck).
You can set the level at any value between -72 dB and 0 dB, in 2-dB steps.
- 4 Press MENU/NO.

Additional information on Automatic Track Marking

- When recording from a CD player or MD deck connected to the DIGITAL (OPTICAL) IN connector, the entire material may be recorded as a single track in the following cases:
 - When you consecutively record the same track two or more times using single-track repeat play.
 - When you consecutively record two or more tracks with the same track number but from different CDs or MDs.
 - When you record tracks from certain CD or multi-disc players.

In such cases, divide the track by editing function (page 31).

continued

Marking Track Numbers While Recording (continued)

- Track marking may not occur in the following tracks:
 - Tracks that are less than 4 seconds long (in stereo, monaural, or LP2 stereo mode).
 - Tracks that are less than 8 seconds long (in LP4 stereo mode).
- When recording from a component connected to the LINE (ANALOG) IN jacks with “T.Mark Off” selected or when recording from a DAT deck or DBS tuner connected to the DIGITAL (OPTICAL) IN connector, the entire material may be recorded as a single track.
- When recording from a DAT deck or DBS tuner connected to the DIGITAL (OPTICAL) IN connector, the deck will mark a track number whenever the sampling frequency of the input signal changes, regardless of the track marking parameter setting (“T.Mark LSync” or “T.Mark Off”).

 You can mark track numbers even after recording has finished. See “Dividing Tracks” on page 31.

Notes

- If you turn off the deck or disconnect the AC power adaptor, the deck will store the last settings (“T.Mark LSync” or “T.Mark Off” and the trigger level) and apply them the next time you turn on the deck.
- The entire contents of a radio broadcast or a cassette may be recorded as a single track if it contains static.

Synchro-recording With the Audio Component of Your Choice

(Music Synchro-recording)

The Music Synchro-recording allows you to automatically synchronize recording on the MD deck with the playing of the selected program source. The Track Marking function, however, will differ according to the program source. For details, see “Marking Track Numbers While Recording” on page 18.

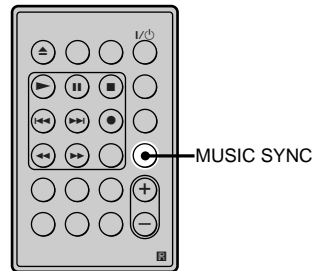

- 1 Do steps 1 to 5 of “Recording on an MD” on pages 12 and 13.
- 2 Press MUSIC SYNC.
The deck changes to recording pause.
- 3 Start playing the program source.
Recording starts automatically.

To stop Music Synchro-recording

Press  (or / on the deck).

Note

During Music Synchro-recording, Smart Space and Auto Cut will operate regardless of their setting (“S.Space On” or “S.Space Off”) (page 17).

Playing an MD

The operations for normal play are explained below.

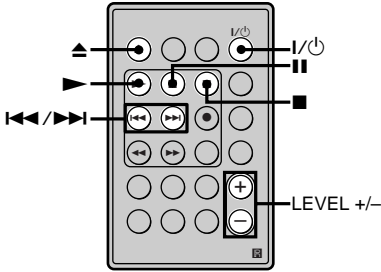

Operations you may want to do during play

To	Press
Stop play	■ (or ■/▲ on the deck)
Pause play	(or ▶ on the deck)
Resume play after pausing	▶ or (or ▶ on the deck)
Locate a succeeding track	▶▶ repeatedly (or turn ◀◀/▶▶ clockwise on the deck)
Locate the beginning of the current track or a preceding track	◀◀ repeatedly (or turn ◀◀/▶▶ counterclockwise on the deck)
Eject the MD	EJECT ▲ (or ■/▲ on the deck) after stopping play

- 1 Turn on the amplifier and select MD on the amplifier.
- 2 Press I/O to turn on the deck.
The switch indicator on the deck turns off.
- 3 Insert an MD (page 4).
- 4 If necessary, press ◀◀/▶▶ repeatedly (or turn ◀◀/▶▶ on the deck) to locate the track you want to start playing from.
If you want to play from the first track, go to step 5.
- 5 Press ▶ (or ▶|| on the deck).
The deck starts to play.
- 6 Adjust the volume on the amplifier.

💡 When you play an MD recorded in LP2 or LP4 stereo mode

“LP2” or “LP4” appears in the display when you press ▶ (or ▶|| on the deck).

💡 Using headphones

Connect headphones to the PHONES jack on the rear of the deck. You can adjust the volume of the headphones with LEVEL +/- . The output level of the ANALOG OUT jacks changes with the volume of the headphones, from -∞ dB to 0 dB. This output is factory set at -14.0 dB. When recording from the deck to another audio component, be sure to set the output level to 0 dB (“ATT” turns off in the display).

Playing a Specific Track

You can use the following procedure while the deck is playing, stopped, or paused to quickly find the beginning of the next track you want to play.

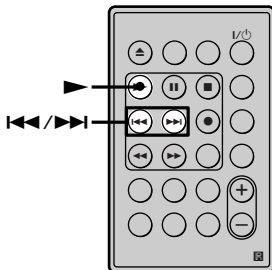

Locating a Particular Point in a Track

You can locate a particular point in a track during play or play pause.

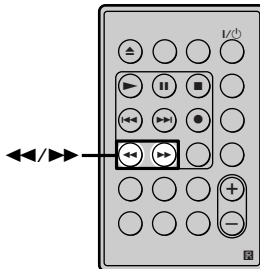

Locating a track

To go to	Do the following:
The next or a succeeding track during play	Press ►► repeatedly (or turn ◀◀/►► clockwise on the deck).
A preceding track during play	Press ◀◀ repeatedly (or turn ►►/◀◀ counterclockwise on the deck).
The beginning of the current track during play	Press ◀◀ (or turn ◀◀/►► counterclockwise on the deck) once.
A specific track while the deck is stopped	Press ◀◀/►► repeatedly (or turn ◀◀/►► on the deck) until the track number you want to go to appears in the display, then press ►► (or ►►◄◄ on the deck).

To locate the last track of the MD quickly

While the deck is stopped, press ◀◀ repeatedly (or turn ◀◀/►► counterclockwise on the deck).

If you locate a track while the deck is stopped or paused

The deck will still be stopped or paused at the beginning of the located track.

Locating a point while monitoring the sound

Hold down ◀◀/►► during play.

You will hear intermittent playback as the disc goes forward or reverse. When you reach the point, release the button.

Notes

- If the disc reaches the end while you're pressing ►►, the deck stops.
- Tracks that are only a few seconds long may be too short for monitoring. For such tracks, play the MD at normal speed.

Locating a point by observing the time indication

Hold down ◀◀/►► during play pause.

The elapsed playing time of the track appears in the display. When you reach the point, release the button. No sound is output during this time.

When "- Over -" appears in the display

The disc has reached the end while you're pressing ►►. Press ◀◀ (or turn ◀◀/►► counterclockwise on the deck) to go back.

Playing Tracks Repeatedly

You can play an entire MD repeatedly. This function can be used with Shuffle Play to repeat all the tracks in random order (page 24), or with Program Play to repeat all the tracks in the program (page 25). You can also repeat a specific track or portion within a track.

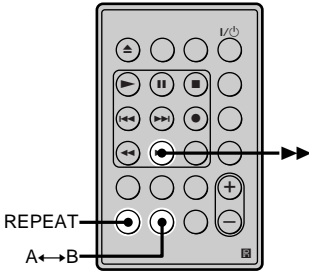

Note

If you turn off the deck or disconnect the AC power adaptor, the deck will store the last setting of the repeat play (“Repeat All” and “Repeat 1” only) and recall it the next time you turn on the deck.

Repeating all the tracks on the MD (Repeat All Play)

Press REPEAT repeatedly until “Repeat All” appears in the display.

When you play an MD, the deck repeats the tracks as follows:

When the play mode is	The deck repeats
Normal play (page 21)	All the tracks in sequence
Shuffle Play (page 24)	All the tracks in random order
Program Play (page 25)	All the tracks in the program in sequence

To stop Repeat All Play

Press ■ (or ■/▲ on the deck).

To resume normal play

Press REPEAT repeatedly until “Repeat Off” appears in the display.

Repeating the current track (Repeat 1 Play)

While the track you want to repeat is being played, press REPEAT repeatedly until “Repeat 1” appears in the display.

Repeat 1 Play starts.

To stop Repeat 1 Play

Press ■ (or ■/▲ on the deck).

To resume normal play

Press REPEAT repeatedly until “Repeat Off” appears in the display.

Repeating a specific portion within a track (Repeat A-B Play)

You can specify one portion within a track to be played repeatedly. Note that the portion that you specify must be within the boundaries of a single track.

- 1 While the deck is playing, press A↔B at the starting point (point A) of the portion to be played repeatedly. “REP A-” lights up and “B” flashes in the display.

- 2 Continue playing the track or press ►► to locate the ending point (point B), then press A↔B. “REP A-B” lights up and Repeat A-B Play starts.

continued

Playing Tracks Repeatedly (continued)

To stop Repeat A-B Play and resume normal play

Press REPEAT or CLEAR.

 You can set a new starting point and ending point during Repeat A-B Play

You can change the current ending point to a new starting point, then specify a new ending point to repeat a portion right after the current portion.

1 During Repeat A-B Play, press A↔B.

The current ending point changes to the new starting point (point A).

“REP A-” lights up and “B” flashes in the display.

2 Locate the new ending point (point B) and press A↔B.



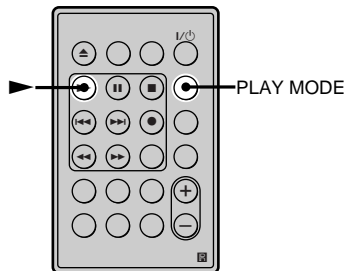

“REP A-B” lights up and the deck starts to repeat the newly specified portion.

Playing Tracks in Random Order (Shuffle Play)

When you select Shuffle Play, the deck plays all the tracks on the MD in random order.







1 While the deck is stopped, press PLAY MODE repeatedly until “SHUF” lights up in the display.







2 Press  (or   on the deck). Shuffle Play starts.
 appears while the deck is “shuffling” the tracks.

To resume normal play

While the deck is stopped, press PLAY MODE repeatedly until “SHUF” turns off.

 You can locate tracks during Shuffle Play

Press /  repeatedly (or turn /  on the deck).

- To locate the next track or a later track to be played, press  repeatedly (or turn /  clockwise on the deck).
- To locate the beginning of the current track, press  (or turn /  counterclockwise on the deck). Note that you can't locate and play the tracks that have already been played once.

Creating Your Own Program (Program Play)

You can pick out the tracks that you like and specify the playback order in a program containing up to 25 tracks.

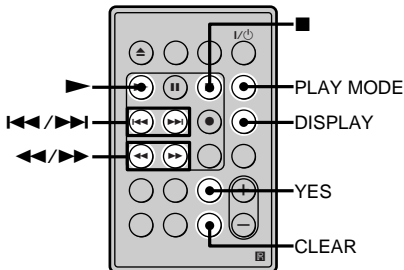

- 4 Repeat step 3 to enter other tracks.
- 5 Press YES.
“Complete!!” appears and the program is completed.
- 6 Press PLAY MODE repeatedly until “PGM” lights up in the display.
- 7 Press ► (or ►|| on the deck).
Program Play starts.

Programming the tracks

- 1 While the deck is stopped, press MENU/NO twice.
“Setup Menu” appears in the display.
- 2 Press ◀◀/▶▶ repeatedly (or turn ◀◀/▶▶ on the deck) until “Program ?” appears, then press YES (or ◀◀/▶▶ on the deck).
- 3 Press ◀◀/▶▶ repeatedly (or turn ◀◀/▶▶ on the deck) until the track number you want to add to the program appears, then press ►► (or ◀◀/▶▶ on the deck).

If you entered the wrong track number

Press ◀◀/▶▶ repeatedly until the wrong track number flashes, then do step 3 above again.

To check the total playing time of the program

Press DISPLAY.

To stop Program Play

Press ■ (or ■/▲ on the deck).

To resume normal play

Press PLAY MODE repeatedly until “PGM” turns off.

💡 You can change the program number of a track

If you press ◀◀ while “0” is flashing, the number of the last track in the program will begin to flash. You can change the number at this time. You can also change the number by pressing CLEAR to clear the current number, and then entering the new number.

💡 The program remains even after Program Play ends or is stopped

Press ►► (or ►►|| on the deck) to play the program again.

Notes

- If you eject the MD or disconnect the AC power adaptor, the program will be lost.
- The display shows “- - - -” when the total playing time of the program exceeds 999 minutes.
- “ProgramFull!” appears when you program 25th track.

continued

Checking the contents of the program

While the deck is stopped and “PGM” lights up, press DISPLAY repeatedly.

The first several tracks in the program appear in the display. To see the rest of the program, press **▶▶▶** repeatedly (or turn **◀◀/▶▶▶** clockwise on the deck).

Changing the contents of the program

While the deck is stopped and “PGM” lights up, do steps 1 and 2 of “Programming the tracks” on page 25, followed by one of the procedures below:

To	Do the following:
Erase a track	Press ◀◀/▶▶▶ repeatedly until the number of the unwanted track flashes, then press CLEAR.
Erase all tracks	Press CLEAR repeatedly until all the track numbers disappear.
Add a track at the beginning of the program	Press ◀◀ repeatedly until “0” flashes before the first track number, then do steps 3 to 5 of “Programming the tracks” on page 25.
Adding a track in the middle of the program	Press ◀◀/▶▶▶ repeatedly until the number of the track right after the position where you wish to insert a track begins to flash. Then press ◀◀/▶▶▶ repeatedly (or turn ◀◀/▶▶▶ on the deck) until “0” flashes. Do steps 3 to 5 of “Programming the tracks” on page 25.
Add a track to the end of the program	Press ▶▶▶ repeatedly until “0” flashes after the last track number, then do steps 3 to 5 of “Programming the tracks” on page 25.
Replace a track	Press ◀◀/▶▶▶ repeatedly until the number of the track to be changed flashes, then do steps 3 to 5 of “Programming the tracks” on page 25.

Tips for Recording From MDs to Tape

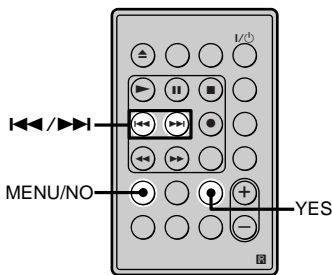

Inserting blanks between tracks during play (Auto Space)

The deck can be set to automatically insert a three-second blank between tracks during play. This function is useful when you're recording from an MD to an analog tape since the three-second blank enables you to use the Multi-AMS function later to locate the beginning of tracks on the tape.

- 1 While the deck is stopped, press MENU/NO twice. "Setup Menu" appears in the display.
- 2 Press **⏮/⏭** repeatedly (or turn **⏮/⏭** on the deck) until "Auto Off" appears, then press YES (or **⏮/⏭** on the deck).
- 3 Press **⏮/⏭** repeatedly (or turn **⏮/⏭** on the deck) to select the setting, then press YES (or **⏮/⏭** on the deck).

To	Select
Turn on Auto Space	Auto Space
Turn off Auto Space	Auto Off (factory setting)

- 4 Press MENU/NO.

Notes

- If you select "Auto Space" and record a selection containing multiple track numbers (for example, a medley or symphony), blank spaces will be created on the tape in between the various sections.
- If you turn off the deck or disconnect the AC power adaptor, the deck will store the last setting ("Auto Space" or "Auto Off") and recall it the next time you turn on the deck.

Pausing after each track (Auto Pause)

You can set the deck so that it pauses after each track to give you time to locate the next track to be recorded.

- 1 While the deck is stopped, press MENU/NO twice. "Setup Menu" appears in the display.
- 2 Press **⏮/⏭** repeatedly (or turn **⏮/⏭** on the deck) until "Auto Off" appears, then press YES (or **⏮/⏭** on the deck).
- 3 Press **⏮/⏭** repeatedly (or turn **⏮/⏭** on the deck) to select the setting, then press YES (or **⏮/⏭** on the deck).

To	Select
Turn on Auto Pause	Auto Pause
Turn off Auto Pause	Auto Off (factory setting)

- 4 Press MENU/NO.

To resume play after pausing
Press **▶** (or **▶||** on the deck).

Note

If you turn off the deck or disconnect the AC power adaptor, the deck will store the last setting ("Auto Pause" or "Auto Off") and recall it the next time you turn on the deck.

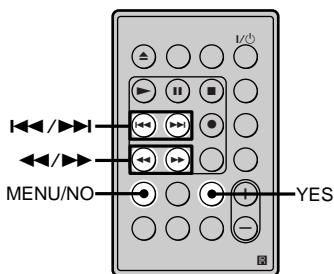

Brief descriptions of buttons used to edit MDs

The buttons below are used to erase, divide, move, or combine tracks on the MD.

Note

The operation of these buttons is different when naming a track or MD. For details, see "Naming Tracks or MDs" on page 35.

MENU/NO button: Press to edit tracks. While editing, press to cancel editing.

◀◀/▶▶ buttons: Press to select an editing operation or track number. You can also use these buttons to specify points in a track for erasure or track division. You can also perform the same operation by turning ▶▶/◀◀ on the deck.

YES button: Press to enter a selection. You can also perform the same operation by pressing ▶▶/◀◀ on the deck.

◀/▶ buttons: Press to specify the unit (minute, second, or frame) by which the MD is advanced when you press ▶▶/◀◀ repeatedly. You can also use these buttons to locate the end point of the portion to be erased.

For further details on the function of each button, see the sections on editing operations.

About indication which appears while editing

When "Protected" and "C11" alternate in the display

The record-protect slot is open. To edit the MD, slide the tab to close the slot. For details, see "To prevent accidental erasure of the recorded material" on page 13.

About indications which appear after editing

When "TOC" lights up in the display

Editing has finished but the TOC (Table of Contents) on the MD has not been updated to reflect the editing results. The editing will be lost if you disconnect the AC power adaptor while the indication is on. The TOC will be updated only when you eject the MD or turn off the MD deck.

When "TOC Writing" flashes in the display

The deck is updating the TOC. Do not disconnect the AC power adaptor or move the deck while the indication flashes.

Erasing Tracks

You can erase a track or part of a track simply by specifying the number of the track or the portion within a track to be erased. You can also erase all the tracks on an MD at one time.

Erasing a track

Specify the number of the track you want to erase.

Example: Erasing the second track

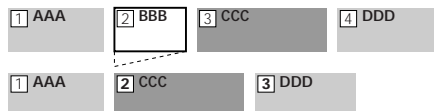

When you erase a track, all the tracks after the one erased are automatically renumbered. For example, if you erase track number 2, the previous track number 3 becomes track number 2 and the previous track number 4 becomes track number 3, and so on.

- 1 While the deck is stopped, playing, or paused, press MENU/NO.
“Edit Menu” appears in the display.
- 2 Press **◀◀/▶▶** repeatedly (or turn **◀◀/▶▶** on the deck) until “Tr Erase ?” appears, then press YES (or **◀◀/▶▶** on the deck).
The deck starts to play the track indicated by the number in the display.
- 3 Press **◀◀/▶▶** repeatedly (or turn **◀◀/▶▶** on the deck) until the track number you want to erase appears.
- 4 Press YES (or **◀◀/▶▶** on the deck).
“Complete!!” appears for a few seconds and the track is erased. The track following the erased track starts to play. If the erased track is the last one on the MD, the track preceding the erased track starts to play.

To cancel the operation

Press MENU/NO or **■** (or **■/▲** on the deck).

💡 If “Erase ???” appears in step 4 above

The track has been record-protected on another MD deck. If you still want to erase the track, press YES (or **◀◀/▶▶** on the deck) again while the indication appears.

💡 To avoid confusion when erasing more than one track

Start erasing from the highest numbered track. This way you’ll avoid renumbering the tracks that you plan to erase.

💡 You can undo the erasure

For details, see “Undoing the Last Edit” on page 38.

Erasing all the tracks on an MD

Do the procedure below to erase all the tracks, track names, and disc name at once.

- 1 While the deck is stopped, playing, or paused, press MENU/NO.
“Edit Menu” appears in the display.
- 2 Press **◀◀/▶▶** repeatedly (or turn **◀◀/▶▶** on the deck) until “All Erase ?” appears, then press YES (or **◀◀/▶▶** on the deck).
“All Erase ???” appears in the display.
- 3 Press YES (or **◀◀/▶▶** on the deck).
“Complete!!” appears for a few seconds and all the tracks, track names, and disc name are erased.

To cancel the operation

Press MENU/NO or **■** (or **■/▲** on the deck).

💡 You can undo the erasure

For details, see “Undoing the Last Edit” on page 38.

continued

Erasing a portion of a track

You can easily erase a portion of a track by specifying the starting and ending points of the erasure.

This is useful for erasing the unnecessary portions of a track recorded from a satellite or FM broadcast.

Example: Erasing portion "B2" of the second track

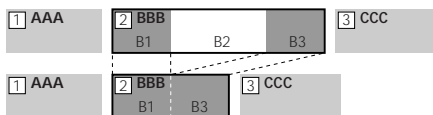

1 While the deck is stopped, playing, or paused, press MENU/NO. "Edit Menu" appears in the display.

2 Press **◀◀/▶▶** repeatedly (or turn **◀◀/▶▶** on the deck) until "A-B Erase ?" appears, then press YES (or **◀◀/▶▶** on the deck).

3 Press **◀◀/▶▶** repeatedly (or turn **◀◀/▶▶** on the deck) until the number of the track containing the portion to be erased flashes, then press YES (or **◀◀/▶▶** on the deck). "- Rehearsal -" and "Point A ok?" alternate in the display and the deck repeatedly plays the first several seconds of the track starting from the point where you pressed YES (or **◀◀/▶▶** on the deck).

4 While monitoring the sound, press **◀◀/▶▶** repeatedly (or turn **◀◀/▶▶** on the deck) to locate the starting point of the portion to be erased (point A).

You can shift point A one frame at a time.* The time indication ("m (minute)," "s (second)," and "f (frame = 1/86 second)") of the current point is displayed and several seconds of the track from that point play back repeatedly.

* Or 2 frames in LP2 stereo mode, or 4 frames in LP4 stereo mode.

To find a point quickly

Specify a unit (minute, second, or frame) by which the MD is advanced when you press **◀◀/▶▶** repeatedly (or turn **◀◀/▶▶** on the deck).

To do this, press **◀◀/▶▶** in step 4 repeatedly to select "m," "s," or "f." The selected unit flashes in the display.

5 Repeat step 4 until you've located point A.

6 Press YES (or **◀◀/▶▶** on the deck) to enter point A.

"Point B set" appears and several seconds of the track from point A play back repeatedly.

7 Continue playing the track or press **▶▶** to locate the ending point of the portion to be erased (point B), then press YES (or **◀◀/▶▶** on the deck).

"A-B Ers" and "Point B ok?" alternate in the display and a few seconds of the track before point A and after point B play back repeatedly.

8 Repeat step 4 until you've located point B.

-
- 9 Press YES (or **◀◀/▶▶** on the deck) to enter point B.

“Complete!!” appears for a few seconds and the portion between point A and B is erased.

To cancel the operation

Press MENU/NO or **■** (or **■/▲** on the deck).

 You can undo the erasure

For details, see “Undoing the Last Edit” on page 38.

Note

In the following cases, “Impossible” appears in the display:

- Point B comes before point A. Reposition point B so that it comes after point A.
- The tracks can't be combined because repeated editing has been done to the track(s). This is a technical limitation of the MD system and is not a mechanical error.

Dividing Tracks

You can divide a recorded track at any point simply by adding a track mark at that point. This is especially useful when you want to divide recorded material which contains multiple tracks but only one track number (see page 18), or when you want to locate a certain point in the track.

Example: Dividing the second track

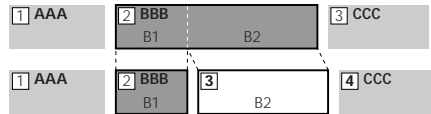

When you divide a track, the total number of tracks increases by one and all tracks following the divided track are automatically renumbered.

-
- 1 While the deck is stopped, playing, or paused, press MENU/NO. “Edit Menu” appears in the display.

 - 2 Press **◀◀/▶▶** repeatedly (or turn **◀◀/▶▶** on the deck) until “Divide ?” appears, then press YES (or **◀◀/▶▶** on the deck).

 - 3 Press **◀◀/▶▶** repeatedly (or turn **◀◀/▶▶** on the deck) until the number of the track you want to divide flashes, then press YES (or **◀◀/▶▶** on the deck).
“-Rehearsal-” appears in the display and the deck repeatedly plays the first several seconds of the track starting from the point where you press YES (or **◀◀/▶▶** on the deck).

continued

Dividing Tracks (continued)

-
- 4 While monitoring the sound, press **⏮/⏭** repeatedly (or turn **⏮/⏭** on the deck) to locate the dividing point.

You can shift point A one frame at a time.* The time indication (“m,” “s,” and “f”) of the current point is displayed and several seconds of the track from that point play back repeatedly.

* Or 2 frames in LP2 stereo mode, or 4 frames in LP4 stereo mode.

To find a point quickly

Specify a unit (minute, second, or frame) by which the MD is advanced when you press **⏮/⏭** repeatedly (or turn **⏮/⏭** on the deck).

To do this, press **⏮/⏭** in step 4 repeatedly to select “m,” “s,” or “f.” The selected unit flashes in the display.

-
- 5 Repeat step 4 until you’ve located the dividing point.

-
- 6 Press YES (or **⏮/⏭** on the deck). “Complete!!” appears for a few seconds and the track is divided. The deck starts to play the newly created track. Note that new track has no name.
-

To cancel the operation

Press MENU/NO or **■** (or **■/▲** on the deck).



You can undo the track division. For details, see “Undoing the Last Edit” on page 38.



You can divide tracks while recording

For details, see “Marking Track Numbers While Recording” on page 18.

Combining Tracks

This function allows you to combine any two tracks into a single track. The two tracks need not to be consecutive nor chronological. You can combine several tracks into a single medley, or several independently recorded portions into a single track. When you combine two tracks, the total number of tracks decreases by one and all tracks following the combined track are renumbered.

Example: Combining the second track and the fourth track

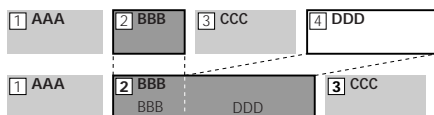

If both of the combined tracks have a track name, the name of the second track is erased.

- 1 While the deck is stopped, playing, or paused, press MENU/NO. “Edit Menu” appears in the display.
- 2 Press ◀◀/▶▶ repeatedly (or turn ◀◀/▶▶ on the deck) until “Combine?” appears, then press YES (or ◀◀/▶▶ on the deck).
- 3 Press ◀◀/▶▶ repeatedly (or turn ◀◀/▶▶ on the deck) until the number of the first track of the two to be combined appears, then press YES (or ◀◀/▶▶ on the deck).
The display for selecting a second track appears and the deck plays the portion where joining will occur (the end of the first track and the beginning of the track following it) repeatedly.

- 4 Press ◀◀/▶▶ repeatedly (or turn ◀◀/▶▶ on the deck) until the number of the second track of the two to be combined appears, then press YES (or ◀◀/▶▶ on the deck).
“Complete!!” appears for a few seconds and the tracks are combined. The deck starts to play the combined track.

To cancel the operation

Press MENU/NO or ■ (or ■/▲ on the deck).

💡 You can undo the combination

For details, see “Undoing the Last Edit” on page 38.

Notes

- If “Impossible” appears in the display, the tracks can’t be combined because repeated editing has been done to the track(s). This is a technical limitation of the MD system and is not a mechanical error.
- You cannot combine tracks which were recorded in different recording modes.

Moving Tracks

This function lets you change the order of any track.

Example: Moving the second track after the third track

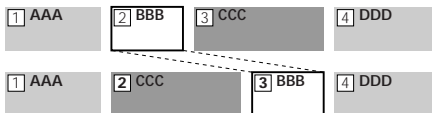

After you move a track, the tracks are renumbered automatically.

-
- 1 While the deck is stopped, playing, or paused, press MENU/NO. “Edit Menu” appears in the display.

 - 2 Press ◀◀/▶▶ repeatedly (or turn ◀◀/▶▶ on the deck) until “Move ?” appears, then press YES (or ◀◀/▶▶ on the deck).

 - 3 Press ◀◀/▶▶ repeatedly (or turn ◀◀/▶▶ on the deck) until the number of the track to be moved appears, then press YES (or ◀◀/▶▶ on the deck).

 - 4 Press ◀◀/▶▶ repeatedly (or turn ◀◀/▶▶ on the deck) until the new track position appears, then press YES (or ◀◀/▶▶ on the deck). “Complete!!” appears for a few seconds and the track is moved. The deck starts to play the moved track.
-

To cancel the operation

Press MENU/NO or ■ (or ■/▲ on the deck).

💡 You can undo the track move
For details, see “Undoing the Last Edit” on page 38.

Naming Tracks or MDs

You can enter a name for a recorded MD as well as for individual tracks. Names can consist of uppercase and lowercase letters, numbers, and symbols. A total number of 1,700 characters can be stored for all the names on the MD.

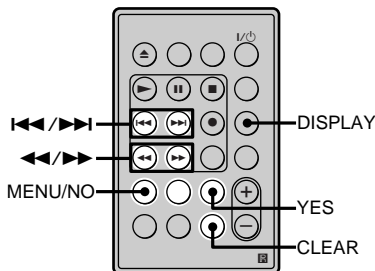

Note

If you name a track while it is being recorded, be sure to finish the naming operation before the track ends. If the track ends before you finish, the entered character data will be discarded and the track will remain unnamed. Also, you can't name tracks while the deck is recording over existing material.

Naming a track or MD

- 1 While the deck is stopped, playing, or paused, press MENU/NO to display "Edit Menu." If you want to name a track that is currently being recorded, go to step 3.
- 2 Press **⏪/⏩** repeatedly (or turn **⏪/⏩** on the deck) until "Name ?" appears, and then press YES (or **⏪/⏩** on the deck).
- 3 Press **⏪/⏩** repeatedly (or turn **⏪/⏩** on the deck) until "Nm In ?" appears, and then press YES (or **⏪/⏩** on the deck).
While the deck is recording, a flashing cursor appears in the display and you can enter a name for the track currently being recorded. In this case, go to step 5.

- 4 Press **⏪/⏩** repeatedly (or turn **⏪/⏩** on the deck) until the number of the track (when naming a track) or "Disc" (when naming the MD) flashes, then press YES (or **⏪/⏩** on the deck).

The cursor begins to flash in the display and it becomes possible to type in the name. In step 4, when the track number that you select begins to flash, the track will automatically begin to play, allowing you hear the track as you name it.

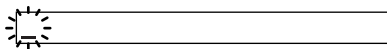

- 5 Press DISPLAY repeatedly to select the character type.

To select	Press repeatedly until
Uppercase letters	"A" appears in the display
Lowercase letters	"a" appears in the display
Numbers or symbols*	"0" appears in the display

* The following symbols can be selected:
' - / , . () ! ? & < > _ = " ; # \$ % @ * `

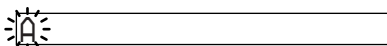

To enter a space
Press **▶▶** while the cursor is flashing. You cannot enter a space at the beginning of the name.

- 6 Press **⏪/⏩** repeatedly (or turn **⏪/⏩** on the deck) to select a character.
The character flashes.



To change a selected character
Repeat step 5 and 6.

continued

Naming Tracks or MDs (continued)

- 7 Press ►► (or ◀◀/▶▶ on the deck).
The flashing character is entered and lights continuously and the cursor shifts to the right.



If you've selected numbers
Press the corresponding number button.
The number is entered and the cursor shifts
to the right.

- 8 Repeat steps 5 to 7 to enter the rest of
the name.

To change a character
Press ◀◀/▶▶ repeatedly until the character
to be changed flashes, then repeat steps 5 to
7.

To erase a character
Press ◀◀/▶▶ repeatedly until the character
to be erased flashes, then press CLEAR.

- 9 Press YES.
The whole name appears in the display.
“Complete !!” appears for a few seconds and
the track or the MD is named.

To cancel the operation

Press MENU/NO or ■ (or ■/▲ on the deck).

 You can undo the naming of a
track or MD

For details, see “Undoing the Last Edit” on page 38.

Copying a track or disc name

You can copy an existing track or disc name and
use it to name another track on the same disc or
the disc itself.

- 1 While the deck is stopped, playing, or
paused, press MENU/NO.
“Edit Menu” appears in the display.
- 2 Press ◀◀/▶▶ repeatedly (or turn
◀◀/▶▶ on the deck) until “Name ?”
appears, then press YES (or ◀◀/▶▶
on the deck).
- 3 Press ◀◀/▶▶ repeatedly (or turn
◀◀/▶▶ on the deck) until “Nm
Copy ?” appears, then press YES (or
◀◀/▶▶ on the deck).
- 4 Press ◀◀/▶▶ repeatedly (or turn
◀◀/▶▶ on the deck) until the
number of the track (when copying the
track name) or “Disc” (when copying
the disc name) flashes, then press YES
(or ◀◀/▶▶ on the deck) to copy the
selected name.

When “No Name” appears in the
display

The selected track or disc has no name.

- 5 Press ◀◀/▶▶ repeatedly (or turn
◀◀/▶▶ on the deck) until the
number of the track (when naming a
track) or “Disc” (when naming a disc)
flashes, then press YES (or ◀◀/▶▶
on the deck) to enter the copied name.
“Complete!!” appears for a few seconds and
the name is copied.

To cancel the operation

Press MENU/NO or ■ (or ■/▲ on the deck).

 When “Overwrite ??” appears in step 5 above

The track or the disc selected in step 5 already has a name. If you wish to replace the name, press YES (or ◀/▶) on the deck) again while the indication appears in the display.

If the track has been recorded in MD LP mode with the “LPstamp On” setting (page 16), “Overwrite ??” also appears even if a track name is not assigned. In this case if you copy the track name, the “LP:” indication disappears from the track name.

 You can undo the copying of a track or disc name

For details, see “Undoing the Last Edit” on page 38.

Renaming a track or MD

- 1 Press NAME EDIT/SELECT while the deck is in one of the operating statuses below, depending on what you want to rename.

To rename a track

Press while the deck is playing, paused, recording, or stopped with the track number displayed.

To rename the MD

Press while the deck is stopped with no track number displayed.

A track or disc name appears in the display.

- 2 Hold down CLEAR until the selected name is erased completely.

- 3 Do steps 6 to 9 of “Naming a track or MD” on pages 35 and 36.

Erasing a track or disc name

Use this function to erase the name of a track or disc.

- 1 While the deck is stopped, playing, recording, or paused, press MENU/NO. “Edit Menu” appears in the display.

- 2 Press ◀/▶ repeatedly (or turn ◀/▶ on the deck) until “Name ??” appears, then press YES (or ◀/▶ on the deck).

If the deck is recording, go to step 3.

- 3 Press ◀/▶ repeatedly (or turn ◀/▶ on the deck) until “Nm Erase ??” appears, then press YES (or ◀/▶ on the deck).

If you do the erasure while recording

“Complete!!” appears for a few seconds and the name is erased in step 3.

It is not necessary to go to step 4 in this case.

- 4 Press ◀/▶ repeatedly (or turn ◀/▶ on the deck) until the number of the track (when erasing the track name) or “Disc” (when erasing the disc name) flashes, then press YES (or ◀/▶ on the deck).

“Complete!!” appears for a few seconds and the name is erased.

To cancel the operation

Press MENU/NO or ■ (or ■/▲ on the deck).

 You can undo the erasing of a track or disc name

For details, see “Undoing the Last Edit” on page 38.

continued

Erasing all the names on the MD

You can erase all the track names and the disc name on an MD in a single operation.

- 1 While the deck is stopped, playing, or paused, press MENU/NO.
“Edit Menu” appears in the display.
- 2 Press **⏮/⏭** repeatedly (or turn **⏮/⏭** on the deck) until “Name ?” appears, then press YES (or **⏮/⏭** on the deck).
- 3 Press **⏮/⏭** repeatedly (or turn **⏮/⏭** on the deck) until “Nm All Ers ?” appears, then press YES (or **⏮/⏭** on the deck).
“Nm All Ers??” appears in the display.
- 4 Press YES (or **⏮/⏭** on the deck).
“Complete!!” appears for a few seconds and all the names on the MD are erased.

To cancel the operation

Press MENU/NO or **■** (or **■/▲** on the deck).

 You can undo the erasing of all the names on the MD

For details, see “Undoing the Last Edit” on page 38.

 You can erase all the recorded tracks and names on the MD

For details, see “Erasing all the tracks on an MD” on page 29.

Undoing the Last Edit

You can undo the last edit operation and restore the contents of the MD to the condition that existed before the operation. Note, however, that you can’t undo an edit operation if you perform any of the following operations after the edit:

- Press **●** or MUSIC SYNC on the remote
- Press **●** on the deck
- Turn off the deck or eject the MD
- Disconnect the AC power adaptor.

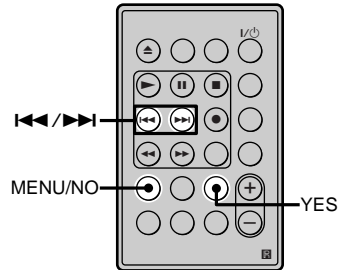

- 1 While the deck is stopped and no track number appears in the display, press MENU/NO.
“Edit Menu” appears in the display.
- 2 Press **⏮/⏭** repeatedly (or turn **⏮/⏭** on the deck) until “Undo ?” appears.
“Undo ?” doesn’t appear if no editing has been done.

- 3 Press YES (or **◀◀/▶▶** on the deck). One of the following messages appears depending on the last edit operation.

Last edit operation	Message
Erasing a track	
Erasing all the tracks on an MD	Erase Undo?
Erasing a portion of a track	
Dividing a track	Divide Undo?
Combining tracks	CombineUndo?
Moving a track	Move Undo?
Naming a track or MD	
Copying a track or disc name	
Renaming a track or MD	Name Undo?
Erasing a track or disc name	
Erasing all the names on the MD	

- 4 Press YES (or **◀◀/▶▶** on the deck). "Complete!!" appears for a few seconds and the MD is restored to the condition that existed before the edit operation.

To cancel the operation

Press MENU/NO or **■** (or **■/▲** on the deck).

Changing the Track Level After Recording

(S.F Edit)

You can change the volume of recorded tracks using S.F (Scale Factor) Edit. The original track is recorded over at the new recording level. When changing the recording level, you can change the overall level, gradually increase the signal level at the start of the track, or gradually decrease the level at the end of the track.

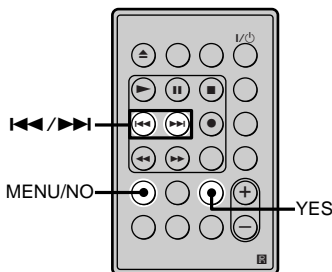

Changing the overall level of a track

- 1 While the deck is stopped, playing, or paused, press MENU/NO. "Edit Menu" appears in the display.
- 2 Press **◀◀/▶▶** repeatedly (or turn **◀◀/▶▶** on the deck) until "S.F Edit?" appears, then press YES (or **◀◀/▶▶** on the deck).
- 3 Press **◀◀/▶▶** repeatedly (or turn **◀◀/▶▶** on the deck) until "Tr Level?" appears, then press YES (or **◀◀/▶▶** on the deck).

continued

Changing the Track Level After Recording (S.F Edit) (continued)

- 4 Press **◀◀/▶▶** repeatedly (or turn **◀◀/▶▶** on the deck) until the track number whose level you want to change appears, then press YES (or **◀◀/▶▶** on the deck).
“Level 0dB” appears in the display.

- 5 While monitoring the sound, press **◀◀/▶▶** repeatedly (or turn **◀◀/▶▶** on the deck) to change the track level without turning on the rightmost indicators on the peak level meters. You can set the level at any value between -12 dB to +12 dB, in 2-dB steps.



Make sure that those indicators do not always turn on.

- 6 Press YES (or **◀◀/▶▶** on the deck).
“S.F Edit ok?” appears in the display.
- 7 Press YES (or **◀◀/▶▶** on the deck).
The deck starts recording over the original track in the specified level. “S.F Edit: XX%” appears to show the recording progress while the track is being recorded over. The process takes approximately equal to or longer than the playback time of the track. When the process finishes, “Complete!!!” appears in the display for a few seconds.

Changing the level gradually at the beginning or the end of the track

- 1 While the deck is stopped, playing, or paused, press MENU/NO.
“Edit Menu” appears in the display.
- 2 Press **◀◀/▶▶** repeatedly (or turn **◀◀/▶▶** on the deck) until “S.F Edit ?” appears, then press YES (or **◀◀/▶▶** on the deck).
- 3 Press **◀◀/▶▶** repeatedly (or turn **◀◀/▶▶** on the deck) until “Fade In ?” (when increasing the level gradually at the beginning of the track) or “Fade Out ?” (when decreasing the level gradually at the end of the track) appears, then press YES (or **◀◀/▶▶** on the deck).
- 4 Press **◀◀/▶▶** repeatedly (or turn **◀◀/▶▶** on the deck) until the track number whose level you want to change appears, then press YES (or **◀◀/▶▶** on the deck).
“Time 5.0s” appears in the display.
- 5 While monitoring the sound, press **◀◀/▶▶** repeatedly (or turn **◀◀/▶▶** on the deck) to change duration of the increase or decrease of the level.
The deck plays the portion that will be recorded over. You can set the duration at any value between 1 second and 15 seconds, in 0.1-second steps.
- 6 Press YES (or **◀◀/▶▶** on the deck).
“S.F Edit ok?” appears in the display.

7 Press YES (or ◀◀/▶▶ on the deck).

The deck starts recording over the specified portion of the original track. “S.F Edit: XX%” appears to show the recording progress while the portion is being recorded over. When the process finishes, “Complete!!” appears in the display for a few seconds.

To cancel the operation

Press MENU/NO or ■ (or ■/▲ on the deck) in steps 1 to 6 above. After you press YES (or ◀◀/▶▶ on the deck) in step 7, you can't cancel the operation.

Notes

- Do not disconnect the AC power adaptor or move the deck while the recording is in progress. This may damage the recording data preventing recording from being performed properly.
- You can't change the level of tracks recorded in LP2 or LP4 mode.
- Do not use an MD that is damaged or dirty. This may prevent the track from being recorded properly.
- Repeated changes of the track level using the S.F Edit function results in poor sound quality.
- Once the track level has been changed, the track level will not return to the exact original level, even if you attempt to return it by performing the S.F Edit function again. Note also that you cannot undo the S.F Edit function.

Fade In and Fade Out Recording/Playback

Fade-in Recording/playback gradually increases the signal level at the start of recording/playback. Fade-out Recording/playback gradually decreases the signal level at the end of recording/playback.

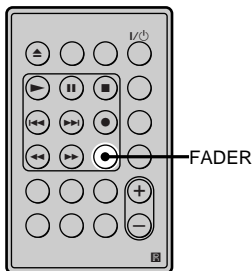

Note

The output level of the DIGITAL (OPTICAL) OUT connector does not vary during recording or playback.

Fade-in Recording/Playback

During recording/playback pause, press FADER.

◀ flashes in the display and the deck performs Fade-in Recording/Playback for five seconds until the counter reaches “0.0s.”

Fade-out Recording/Playback

During recording/playback, press FADER.

▶ flashes in the display and the deck performs Fade-out Recording/Playback for five seconds until the counter reaches “0.0s,” then pauses.

You can change the duration of Fade-in and Fade-out Recording/Playback

- 1 While the deck is stopped, press MENU/NO twice. “Setup Menu” appears in the display.
- 2 Press ◀◀/▶▶ repeatedly (or turn ◀◀/▶▶ on the deck) to select the setting, then press YES (or ◀◀/▶▶ on the deck).

To change the duration of	Select
Fade-in Recording/Playback	F.in
Fade-out Recording/Playback	F.out

- 3 Press ◀◀/▶▶ repeatedly (or turn ◀◀/▶▶ on the deck) to select the duration, then press YES (or ◀◀/▶▶ on the deck). Both the Fade-in and Fade-out durations can be set in 0.1-second steps. To set the duration in 1-second steps, use ◀◀/▶▶ instead.

- 4 Press MENU/NO.

Precautions

On safety

- Should any solid object or liquid fall into the cabinet, unplug the deck and have it checked by qualified personnel before operating it any further.
- The use of optical instruments with this product will increase eye hazard.

On power sources

- Before operating the deck, check that the operating voltage of the deck is identical with your local power supply. The operating voltage is indicated on the nameplate on the AC power adaptor.
- The unit is not disconnected from the AC power source (mains) as long as it is connected to the wall outlet, even if the unit itself has been turned off.
- If you are not going to use the deck for a long time, be sure to disconnect the AC power adaptor from the wall outlet. To disconnect the AC power adaptor, grasp the plug itself; never pull the cord.
- AC power adaptor must be changed only at the qualified service shop.

On condensation in the deck

If the deck is brought directly from a cold to a warm location, or is placed in a very damp room, moisture may condense on the lenses inside the deck. Should this occur, the deck may not operate properly. In this case, remove the MD and leave the deck turned on for about an hour until the moisture evaporates.

On the MiniDisc cartridge

- Do not open the shutter to expose the MD.
- Do not place the cartridge where it will be subject to extremes of sunlight, temperature, moisture or dust.

On cleaning

Clean the cabinet, panel and controls with a soft cloth slightly moistened with a mild detergent solution. Do not use any type of abrasive pad, scouring powder or solvent such as alcohol or benzene.

Replacing the battery in the remote

Slide out and remove the battery case, and insert a new lithium battery CR2025 with the + side facing up. And then, slide the battery case back in.

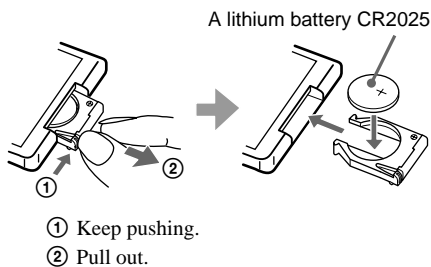

CAUTION

Danger of explosion if battery is incorrectly replaced. Replace the battery only with the same or equivalent type recommended by the manufacturer. Discard used batteries according to the manufacturer's instructions.

If you have any questions or problems concerning your deck, please consult your nearest Sony dealer.

Handling MDs

The MD is enclosed in a cartridge to protect the disc from debris or fingerprints and to make it easy to handle.

However, the presence of debris or a warped cartridge may inhibit the disc from operating properly. To assure that you can always listen to the highest quality music, follow the precautions below:

- Do not touch the internal disc directly. Forcing the shutter open may damage the internal disc.
- Be sure to stick the labels supplied with the MD to the appropriate positions. The shape of the labels may vary depending on the MD brand.

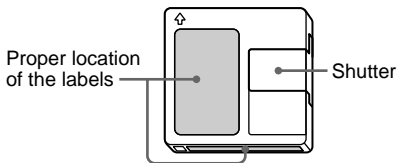

Where to keep the MDs

Do not place the cartridge where it may be exposed to direct sunlight or extremely high heat and humidity.

Regular maintenance

Wipe dust and debris from the surface of the cartridge with a dry cloth.

System Limitations

The recording system in your deck is radically different from those used in cassette and DAT decks and is characterized by the limitations described below. Note, however, that these limitations are due to the inherent nature of the MD recording system itself and not to mechanical causes.

“Disc Full” appears in the display even before the MD has reached the maximum recording time

When 255 tracks have been recorded on the MD, “Disc Full” appears regardless of the total recorded time. More than 255 tracks can’t be recorded on the MD. To continue recording, erase unnecessary tracks or use another recordable MD.

“Disc Full” appears before the maximum number of tracks is reached

Fluctuations in emphasis within tracks are sometimes interpreted as track intervals, incrementing the track count and causing “Disc Full” to appear.

The remaining recording time does not increase even after erasing numerous short tracks

Tracks under 12 seconds* in length are not counted and so erasing them may not lead to an increase in the recording time.

* When recording in stereo mode. (Approx. 24 seconds in mono or LP2 mode, and approx. 48 seconds in LP4 mode.)

The total recorded time and the remaining recordable time on the MD may not total the maximum recording time

Recording is done in minimum units of 2 seconds* each, no matter how short the material. The contents recorded may thus be shorter than the maximum recording capacity. Disc space may also be further reduced by scratches.

* When recording in stereo mode. (Approx. 4 seconds in mono or LP2 mode, and approx. 8 seconds in LP4 mode.)

Limitations when recording over an existing track

- The correct remaining recordable time may not be displayed.
- You may find it impossible to record over a track if that track has been recorded over several times already. If this happens, erase the track (see page 29).
- The remaining recordable time may be shortened out of proportion to the total recorded time.
- Recording over a track to eliminate noise is not recommended since this may shorten the duration of the track.
- You may find it impossible to name a track while recording over an existing track.

Tracks created through editing may exhibit sound dropout as you're searching for a point while monitoring the sound.

Some tracks can't be combined with others

Tracks may not be combined if they have been edited.

Track numbers are not marked correctly

Incorrect assignment or marking of track numbers may result when CD tracks are divided into several smaller tracks during digital recording. Also, when the Automatic Track Marking is activated during recording, track numbers may not be marked as in the original, depending on the program source.

"TOC Reading" appears for a long time

If the inserted recordable MD is brand new, "TOC Reading" appears in the display longer than for MDs that have already been used.

The correct recorded/playing time may not be displayed during playback of MDs recorded in monaural mode.

Troubleshooting

If you experience any of the following difficulties while using the deck, use this troubleshooting guide to help you remedy the problem. Should any problem persist, consult your nearest Sony dealer.

The deck does not operate or operates poorly.

- The MD may be dirty or damaged. Replace the MD.
- Only I/Ⓞ is operable while the MD deck is being controlled by a personal computer.

The deck does not play.

- Moisture has formed inside the deck. Take the MD out and leave the deck in a warm place for several hours until the moisture evaporates.
- The deck is not on. Press I/Ⓞ to turn the deck on.
- The deck may not be connected to the amplifier correctly. Check the connection.
- The MD is inserted in the wrong direction. Slide the MD into the disc slot with the label side up and the arrow pointing towards the slot.
- The MD may not be recorded. Replace the disc with one that has been recorded.

The sound has a lot of static.

- Strong magnetism from a television or a similar device is interfering with operations. Move the deck away from the source of strong magnetism.

The deck does not record.

- The MD is record-protected. Slide the record-protect tab and close the slot.
- The deck is not connected properly to the program source. Check the connection.
- Select the correct program source using INPUT.
- The recording level is not adjusted properly. Adjust the recording level.
- A premastered MD is inserted. Replace it with a recordable MD.
- There is not enough time left on the MD. Replace it with another recordable MD with fewer recorded tracks, or erase unnecessary tracks.
- There has been a power failure or the AC power adaptor has been disconnected during recording. Data recorded to that point may be lost. Repeat the recording procedure.

A message and a three-digit alphanumeric code alternate in the display.

- The Self-Diagnosis Function is on. See the table on page 51.
-

Note

If the deck does not operate properly even after you've attempted the prescribed remedies, turn off the deck, then reinsert the AC power adaptor into the AC power outlet.

Specifications

System	MiniDisc digital audio system
Disc	MiniDisc
Laser	Semiconductor laser ($\lambda = 780 \text{ nm}$) Emission duration: continuous
Laser output	Less than $44.6 \mu\text{W}^*$ * This output is the value measured at a distance of 200 mm from the objective lens surface on the Optical Pick-up Block with 7 mm aperture.
Laser diode	Material: GaAlAs
Revolutions (CLV)	400 rpm to 900 rpm
Error correction	Advanced Cross Interleave Reed Solomon Code (ACIRC)
Sampling frequency	44.1 kHz
Coding	Adaptive Transform Acoustic Coding (ATRAC)
Modulation system	EFM (Eight-to-Fourteen Modulation)
Number of channels	2 stereo channels
Frequency response	5 to 20,000 Hz $\pm 0.5 \text{ dB}$
Signal-to-noise ratio	Over 94 dB during playback
Wow and flutter	Below measurable limit

Inputs

LINE (ANALOG) IN	Jack type: stereo-mini Impedance: 47 kilohms Rated input: 500 mVrms Minimum input: 125 mVrms
DIGITAL (OPTICAL) IN	Connector type: square optical Impedance: 660 nm (optical wave length)

Outputs

LINE (ANALOG) OUT (VARIABLE)	Jack type: stereo-mini Rated output: 1 Vrms (at 50 kilohms) Load impedance: Over 10 kilohms
DIGITAL (OPTICAL) OUT	Connector type: square optical Rated output: -18 dBm Impedance: 660 nm (optical wave length)
PHONES	Jack type: stereo-mini Rated output: 5 mW Load impedance: 32 ohms

General

Where purchased	Power requirements*
U.S.A. and Canada	120 V AC, 60 Hz
Other countries	220 – 230 V AC, 50/60 Hz

* Using an AC power adaptor (supplied)

Power consumption	7 W
Dimensions (approx.)	$152 \times 52 \times 255 \text{ mm}$ ($6 \times 2 \frac{1}{8} \times 10 \frac{1}{8}$ inches) (w/h/d) incl. projecting parts and controls
Mass (approx.)	1.0 kg (2 lb 4 oz)

Supplied accessories

See page 8.

US and foreign patents licensed from Dolby Laboratories Licensing Corporation.

Design and specifications are subject to change without notice.

Display Messages

The following table explains the various messages that appear in the display. Messages are also displayed by the deck's Self-Diagnosis function (see page 49).

Message	Meaning
Auto Cut	The Auto Cut function is on (page 17).
Blank Disc	A new (blank) or erased MD has been inserted.
Cannot Copy	An attempt was made to make a second copy from a digitally dubbed MD (page 11).
Cannot Edit	An attempt was made to edit the MD during Program or Shuffle Play, or to edit an MD recorded in LP2 or LP4 stereo recording mode. Or the MD is record-protected.
Disc Full	The MD is full (page 44).
Impossible	The deck cannot do the specified operation.
Incomplete!!	Fade-in or Fade-out recording or playback was not successfully done due to vibrations applied to the deck or scratches or dirt on the disc.
Initialize (flashing)	The Setup Menu settings have been lost, the material on the MD was not properly recorded, or the status of the deck before the power was last turned off was not memorized. (This message flashes in the display for about four seconds when you turn off the deck by pressing I/⏪.)
Name Full	The naming capacity of the MD has reached its limit (about 1,700 characters).
No Change	You performed S.F. Edit without specifying the recording level, resulting in no change of recording level.
No Disc	There is no MD in the deck.
No Name	The track or disc has no name.
No Program!!	You tried to start Program Play when no program exists.

Premastered	An attempt was made to record on a premastered MD.
ProgramFull!	The program contains the maximum number of tracks. You cannot add any more tracks.
REMOTE	The MD deck is being controlled by an external device connected to the deck.*
S.F Edit!	You tried to do another operation while the S.F Edit is in progress. You cannot perform any other operations at this time.
S.F Edit NOW	You pressed I/⏪ while in S.F Edit (changing the recording level after recording, Fade-in, or Fade-out) mode. If you turn off the deck while in S.F Edit mode, any changes that you have made will not saved properly. Finish the editing and exit S.F Edit mode before turning off the deck. If you wish to turn off the deck at this time, press I/⏪ again while this indication appears in the display.
Smart Space	The Smart Space function is on (page 17).
Text Protect	The CD-TEXT information being recorded is protected and can't be copied.
TOC Reading	The deck is checking the TOC (Table Of Contents) on the MD.

* If "REMOTE" appears under other circumstances, turn off the deck, then turn it on again.

Edit Menu Table

The following table provides a quick guide to the various editing functions that you can perform using the Edit Menu.

To access the Edit Menu

Press MENU/NO to display “Edit Menu.”

Note

The available menu items may vary according to the current status of the deck.

Menu item	Sub-item	Function	Reference page(s)
Name ?	Nm In ?	Names a track or an MD.	35
	Nm Erase ?	Erases a name.	37
	Nm All Ers ?	Erases all the names on an MD.	38
	Nm Copy ?	Copies a name to a track or an MD.	36
Tr Erase ?	—	Erases a track.	29
Move ?	—	Moves a track.	34
Combine ?	—	Combines tracks.	33
Divide ?	—	Divides a track.	31
A-B Erase ?	—	Erases a portion of a track.	30
All Erase ?	—	Erases all the tracks on an MD.	29
S.F Edit ?	Tr Level ?	Changes the overall track level after recording.	39
	Fade In ?	Changes the level at the beginning of a track after recording.	40
	Fade Out ?	Changes the level at the end of a track after recording.	40
Undo ?	—	Undoes the last edit operation.	38
Setup ?	—	Enters Setup Menu (page 50) directly.	—

Setup Menu Table

The following table provides an overview of the various Setup Menu items, including their parameters, factory settings, and reference page in the manual.

To access the Setup Menu

While the deck is stopped, press MENU/NO twice to display “Setup Menu.”

Menu item	Function	Parameters	Factory setting	Reference page(s)
Program ?	Creates a program.	—	—	25
T.Mark	Turns Automatic Track Marking on or off.	Off/LSync	LSync	19
LS(T)	Changes the trigger level for Automatic Track Marking.	-72 to 0dB*	-50 dB	19
Auto	Turns Auto Space and Auto Pause on or off.	Off/Space/Pause	Off	27
S.Space	Turns Smart Space and Auto Cut on or off.	On/Off	On	17
P.Hold	Continuously displays the level of the strongest signal.	On/Off	On	15
F.in	Sets the duration of Fade-in Recording/playing	1.0 to 15.0 s	5.0 s	42
F.out	Sets the duration of Fade-out Recording/playing	1.0 to 15.0 s	5.0 s	42
Stereo Rec	Selects the recording mode.	Stereo (no indication)/LP2/LP4/Mono	Stereo	15
Ain	Changes the input level of the ANALOG IN jacks	-∞ to 12.0 dB	0.0 dB	15
Opt	Changes the input level of the DIGITAL (OPTICAL) IN connector	-∞ to 18.0 dB	0.0 dB	15
Aout	Changes the output level of the ANALOG OUT jacks	-∞ to 0.0 dB	-14 dB	10
LPstamp	Turns LP Stamp function on or off.	On/Off	On	16

* Adjustable in 2 dB steps.

To recall a factory setting

Press CLEAR while selecting the parameter.

Self-Diagnosis Function

The deck's self-diagnosis function automatically checks the condition of the MD deck when an error occurs, then issues a three-digit code and an error message on the display. If the code and message alternate, find them in the following table and perform the indicated countermeasure. Should the problem persist, consult your nearest Sony dealer.

Three-digit code/Message	Cause/Remedy
C11/Protected	The inserted MD is record-protected. ➔ Take out the MD and close the record-protect slot (page 13).
C12/Cannot Copy	An attempt was made to play a disc that is not compatible with this deck (MD data disc, etc.). ➔ Replace the disc.
C13/Rec Error	The recording was not made properly. ➔ Set the deck in a stable surface, and repeat the recording procedure. The inserted MD is dirty (with smudges, fingerprints, etc.), scratched, or substandard in quality. ➔ Replace the disc and repeat the recording procedure.
C13/Read Error	The deck could not read the TOC on the MD properly. ➔ Take out the MD and insert it again.
C14/Toc Error	The deck could not read the TOC on the MD properly. ➔ Insert another disc. ➔ If possible, erase all the tracks on the MD (page 29).
C41/Cannot Copy	The digitally dubbed material cannot be recorded digitally (page 11).
C71/Din Unlock	The sporadic appearance of this message is caused by the digital signal being recorded. This will not affect the recording. While recording from a digital component connected through the DIGITAL (OPTICAL) IN connector, the digital connecting cable was unplugged or the digital component turned off. ➔ Connect the cable or turn the digital component back on.
E0001/MEMORY NG	There is an error in the internal data that the deck needs in order to operate. ➔ Consult your nearest Sony dealer.
E0101/LASER NG	There is a problem with the optical pickup. ➔ Consult your nearest Sony dealer.

Index

A

- Accessories 8
- Audio connecting cord 8, 9, 10
- Auto Cut 17
- Auto Pause 27
- Auto Space 27
- Automatic Track Marking
 - additional information 19
 - how to 18
 - trigger level 19

B

- Battery 8, 43
- Blank
 - erasing during recording. See Smart Space and Auto Cut
 - inserting during play. See Auto Space

C

- Combining 33
- Connection. See Hookups

D

- Displaying
 - disc name 6
 - remaining recordable time 6
 - total number of tracks 6
 - total recorded time 6
 - track name 7
- Dividing 31

E

- Erasing
 - a name 37
 - a portion of a track 30
 - a track 29
 - all names 38
 - all tracks 29

F, G

- Fade-in Recording 42
- Fade-out Recording 42

H

- Hookups
 - analog 9
 - digital 9
 - PC LINK 9
 - personal computer 9

I, J, K

- Input Monitor 17

L

- Level
 - input signal 7
 - output signal. See Output level
 - recording 14
- Locating
 - particular point 22
 - tracks 22
- LP Stamp function 16

M

- Manual Track Marking 18
- MD (MiniDisc)
 - ejecting 13, 21
 - inserting 4
 - premastered 6
 - recordable 6, 12
 - record-protect tab 13
- Monitoring input signal. See Input Monitor
- Moving 34
- Music Synchro-recording 20

N

- Naming
 - copying 36
 - how to 35
 - renaming 37

O

- Optical cable 9, 10
- Output level 21

P, Q

- Pausing
 - after each track. See Auto Pause
 - play 21
 - recording 13
- Peak Hold 15
- Peak level meters 15
- Playing
 - from the first track 21
 - specific track. See Locating
- Program Play
 - changing the contents 26
 - checking the contents 26
 - programming 25

R

- Recording
 - how to 12
 - long times 15
 - mode 15
 - over existing tracks 13
- Remote 5, 8
- Repeat A-B Play 23
- Repeat All Play 23
- Repeat 1 Play 23
- Repeating
 - a portion. See Repeat A-B Play
 - all tracks. See Repeat All Play
 - current track. See Repeat 1 Play

S

- Sampling rate converter 11
- SCMS. See Serial Copy Management System
- Serial Copy Management System 11
- S.F Edit
 - changing overall track level 39
 - changing track level at the beginning 40
 - changing track level at the end 40
- Shuffle Play 24
- Smart Space 17

T

- Table of contents. See TOC
- Time Machine Recording 19
- TOC 11, 28

U, V, W, X, Y, Z

- Undoing 38

Sony  line

<http://www.world.sony.com/>

Printed on recycled paper