

Compact Disc MiniDisc Deck

Operating Instructions



MXD-D3

WARNING

To prevent fire or shock hazard, do not expose the unit to rain or moisture.

To avoid electrical shock, do not open the cabinet. Refer servicing to qualified personnel only.

The laser component in this product is capable of emitting radiation exceeding the limit for Class 1.

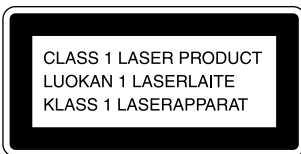

This appliance is classified as a CLASS 1 LASER product. The CLASS 1 LASER PRODUCT MARKING is located on the rear exterior.

The following caution label is located inside of the unit.



IN NO EVENT SHALL SELLER BE LIABLE FOR ANY DIRECT, INCIDENTAL OR CONSEQUENTIAL DAMAGES OF ANY NATURE, OR LOSSES OR EXPENSES RESULTING FROM ANY DEFECTIVE PRODUCT OR THE USE OF ANY PRODUCT.

For the customers in the U.S.A.

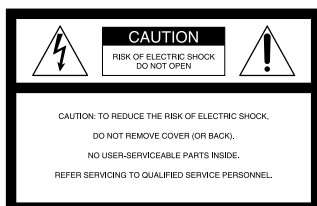

This symbol is intended to alert the user to the presence of uninsulated "dangerous voltage" within the product's enclosure that may be of sufficient magnitude to constitute a risk of electric shock to persons.



This symbol is intended to alert the user to the presence of important operating and maintenance (servicing) instructions in the literature accompanying the appliance.

CAUTION

You are cautioned that any changes or modification not expressly approved in this manual could void your authority to operate this equipment.

INFORMATION

This equipment has been tested and found to comply with the limits for a Class B digital device, pursuant to Part 15 of the FCC Rules. These limits are designed to provide reasonable protection against harmful interference in a residential installation. This equipment generates, uses, and can radiate radio frequency energy and, if not installed and used in accordance with the instructions, may cause harmful interference to radio communications. However, there is no guarantee that interference will not occur in a particular installation. If this equipment does cause harmful interference to radio or television reception, which can be determined by turning the equipment off and on, the user is encouraged to try to correct the interference by one or more of the following measures:

- Reorient or relocate the receiving antenna.
- Increase the separation between the equipment and receiver.
- Connect the equipment into an outlet on a circuit different from that to which the receiver is connected.
- Consult the dealer or an experienced radio/TV technician for help.

Owner's Record

The model and serial numbers are located on the rear of the unit. Record the serial number in the space provided below. Refer to them whenever you call upon your Sony dealer regarding this product.

Model No. MXD-D3

Serial No. _____

For the customers in Canada

CAUTION

TO PREVENT ELECTRIC SHOCK, DO NOT USE THIS POLARIZED AC PLUG WITH AN EXTENSION CORD, RECEPTACLE OR OTHER OUTLET UNLESS THE BLADES CAN BE FULLY INSERTED TO PREVENT BLADE EXPOSURE.

Precautions

On safety

- Should any solid object or liquid fall into the cabinet, unplug the deck and have it checked by qualified personnel before operating it any further.
- The use of optical instruments with this product will increase eye hazard.

On power sources

- Before operating the deck, check that the operating voltage of the deck is identical with your local power supply. The operating voltage is indicated on the nameplate at the rear of the deck.
- The unit is not disconnected from the AC power source (mains) as long as it is connected to the wall outlet, even if the unit itself has been turned off.
- If you are not going to use the deck for a long time, be sure to disconnect the deck from the wall outlet. To disconnect the AC power cord, grasp the plug itself; never pull the cord.
- AC power cord must be changed only at the qualified service shop.

On condensation in the deck

If the deck is brought directly from a cold to a warm location, or is placed in a very damp room, moisture may condense on the lenses inside the deck. Should this occur, the deck may not operate properly. In this case, remove the CD or MD and leave the deck turned on for about an hour until the moisture evaporates.

On handling CDs

- To keep the CD clean, handle the CD by its edge. Do not touch the surface.
- Do not stick paper or tape onto the CD.
- Do not expose the CD to direct sunlight or heat sources such as hot air ducts, nor leave it in a car parked in direct sunlight as there can be a considerable rise in temperature inside the car.

- Sticky adhesives or inks from the CD label, if present, may become attached to internal parts, causing jamming of the CD or malfunction of the unit. Always check the CD label carefully for sticky substances before inserting the CD. Do not use the following types of CDs:
 - Rental or used CDs with adhesive extending out from the edge of the sticker. Check along the edge of the sticker for stickiness.
 - CDs with labels printed with special inks that are sticky to the touch.

On the MiniDisc cartridge

- Do not open the shutter to expose the MD.
- Do not place the cartridge where it will be subject to extremes of sunlight, temperature, moisture or dust.

On cleaning

Clean the cabinet, panel and controls with a soft cloth slightly moistened with a mild detergent solution. Do not use any type of abrasive pad, scouring powder or solvent such as alcohol or benzene.

If you have any questions or problems concerning your deck, please consult your nearest Sony dealer.

Welcome!

Thank you for purchasing the Sony Compact Disc MiniDisc Deck. Before operating the deck, please read this manual thoroughly and retain it for future reference.

About This Manual

Conventions

- Before operating the deck, connect your deck by referring to "Getting Started."
- For basic operations, see "Playing a CD," "Playing an MD," and "Recording a CD to an MD."
- Controls in the instructions are those on the deck; these may, however, be substituted by controls on the remote that are similarly named or, when different, appear in the instructions within brackets.
- The following icons are used in this manual:



Indicates a procedure that requires use of the remote.



Indicates tips for making the task easier and hints.

TABLE OF CONTENTS

Getting Started	4
Unpacking	4
Hooking Up the System	4
Playing a CD	6
Playing an MD	7
Recording a CD to an MD (CD Synchro-Recording)	8
Playing CDs and MDs	10
Using the Display	10
Locating a Specific Track	12
Locating a Particular Point in a Track	12
Adjusting the Output Level	13
Playing Tracks Repeatedly (Repeat Play)	13
Playing in Random Order (Shuffle Play)	14
Creating Your Own Program (Program Play)	14
Falling Asleep to Music (Sleep Timer)	16
Changing the Pitch of the MD (Pitch Control Function)	16
Recording on MDs	17
Notes on Recording	17
Useful Tips for Recording	18
Recording on an MD Manually	19
Adjusting the Recording Level	20
Marking Track Numbers While Recording	21
Recording the Current CD Track (REC-IT Function)	22
Recording a CD to an MD at High Speed (High-Speed CD Synchro-Recording)	23
Synchro-Recording With an External Audio Equipment (Music Synchro-Recording)	24
Starting Recording With Prestored Audio Data (Time Machine Recording)	24
Fading In and Out (Fader)	25
Editing Recorded MDs	26
Notes on Editing	26
Erasing Recordings	26
Erasing a Part of a Track (A-B Erase Function)	27
Dividing Recorded Tracks (Divide Function)	28
Combining Recorded Tracks (Combine Function)	29
Moving Recorded Tracks (Move Function)	30
Labeling Recordings (Name Function)	31
Undoing the Last Edit (Undo Function)	35
Additional Information	36
Display Messages	36
System Limitations	36
Troubleshooting	37
Specifications	38
Guide to the Serial Copy Management System	39
Index	40
Table of Setup Menus	42
Self-Diagnosis Function	43
Notes on CDs	43

Unpacking

Check that you received the following items:

- Audio connecting cords (2)
- Optical cable (1)
- Remote commander (remote) RM-D37M (1)
- Sony R6 (size-AA) batteries (2)
- Power plug adaptor (1) (Singaporean model only)

Inserting batteries into the remote

You can control the deck using the supplied remote. Insert two R6 (size-AA) batteries by matching the + and - on the batteries. When using the remote, point it at the remote sensor  on the deck.

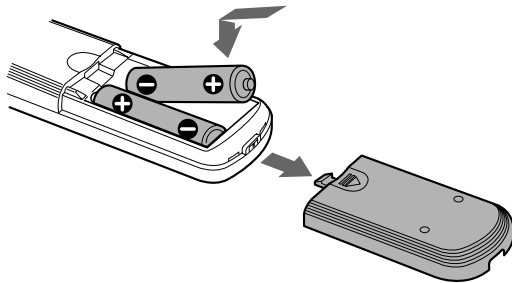

When to replace batteries

With normal use, the batteries should last for about six months. When the remote no longer operates the deck, replace all the batteries with new ones.

Notes

- Do not leave the remote near an extremely hot or humid place.
- Do not drop any foreign object into the remote casing, particularly when replacing the batteries.
- Do not expose the remote sensor to direct sunlight or lighting apparatuses. Doing so may cause a malfunction.
- If you don't use the remote for an extended period of time, remove the batteries to avoid possible damage from battery leakage and corrosion.

Hooking Up the System

Overview

This section describes how to hook up the deck to an amplifier or other components such as a CD player or DAT deck. Be sure to turn off the power of each component before connection.

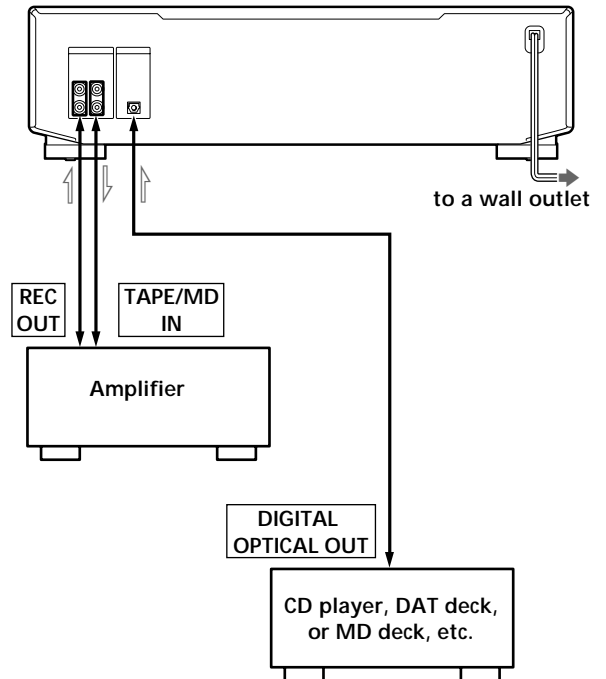

: Signal flow

What cords will I need?

- Audio connecting cords (supplied) (2)

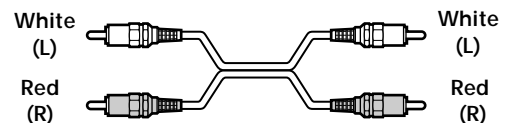

- Optical cable (supplied) (1)

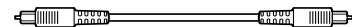

Hookups

Connecting the deck to an amplifier

Connect the amplifier to the LINE (ANALOG) IN/OUT jacks using the audio connecting cords (supplied), making sure to match the color-coded cords to the appropriate jacks on the components: red (right) to red and white (left) to white. Be sure to make connections firmly to prevent hum and noise.

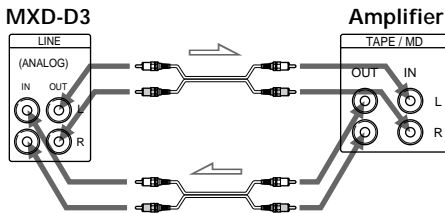

⇒: Signal flow

Connecting the deck to a digital component such as a CD player, DAT deck, or an MD deck

Connect the component through the DIGITAL OPTICAL IN connector with the optical cable (supplied).

Take the caps off the connectors and then insert the plugs parallelly until they click into place. Be sure not to bend or tie the optical cable.

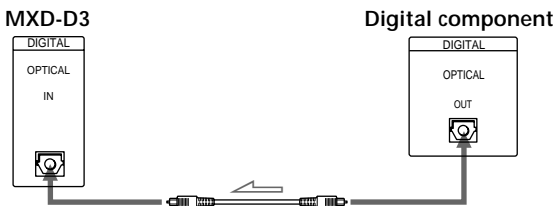

⇒: Signal flow



If "Din Unlock" and "C71" alternate in the display
The optical cable is not connected properly. Check that the connections are secure.



Automatic conversion of digital sampling rates during recording

A built-in sampling rate converter automatically converts the sampling frequency of various digital sources to the 44.1 kHz sampling rate of this deck. This allows you to record sources such as 32- and 48-kHz DAT or satellite broadcasts, as well as compact discs and MDs.

Note

If "Din Unlock" alternates with "C71", or "Cannot Copy" flashes in the display, recording through the DIGITAL OPTICAL IN connector is not possible. In this case, record the program source through the LINE (ANALOG) IN jacks with "ANALOG" selected by INPUT.

Setting the voltage selector (Singaporean model only)

Check that the voltage selector on the rear panel of the deck is set to the local power line voltage. If not, set the selector to the correct position using a screwdriver before connecting the AC power cord to an AC outlet.

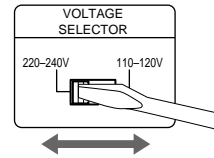

Connecting the AC power cord

Connect the AC power cord to a wall outlet.

Note

Do not connect the AC power cord to a switched outlet.

Playing a CD

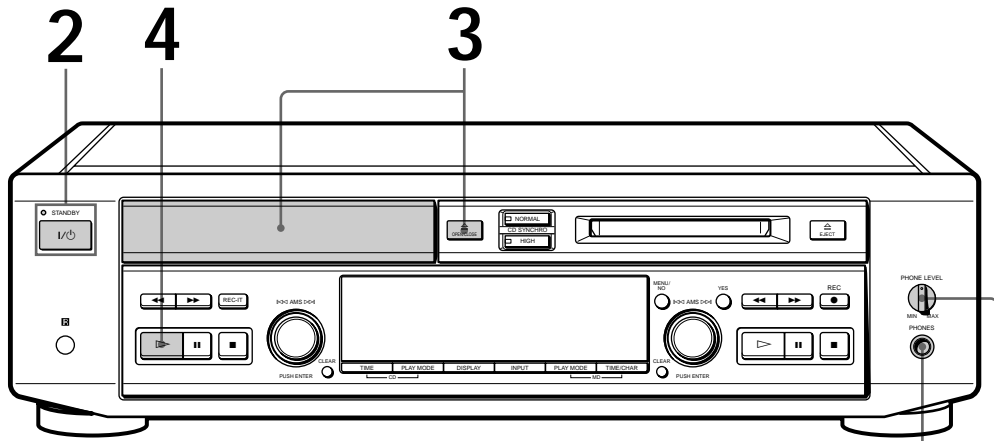





Connect the headphones.

Adjust the headphone volume.



When using the controls on the deck
Use the CD player controls located to the left of the front panel.

When using the remote 
Set SELECT to CD.

Audio output
Output switches automatically to the audio of the CD.

-  You can start playing with the track selected in Step 4
- 1 Turn AMS (or press  or ) to select the track you want to play using the display*.
 - 2 Press AMS or .





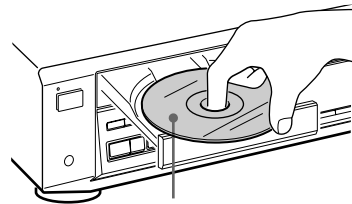

* See "Using the Display" on pages 10 and 11.

- 1** Turn on the amplifier and set the source selector to the position for this deck.
- 2** Press .
The STANDBY indicator turns off.
- 3** Press  OPEN/CLOSE to insert a CD. Press the button again to close the CD tray.
When you play an 8-cm CD, place it on the inner circle of the tray.



With the label side up

- 4** Press .
The deck starts playing. Adjust the volume on the amplifier.

To	Do the following:
Stop playing	Press  .
Pause playing	Press  . Press the button again or press  to resume playing.
Go to the next track	Turn AMS clockwise (or press  on the remote).
Go to the beginning of the current track or the preceding track	Turn AMS counterclockwise (or press  on the remote).
Take out the CD	Press  OPEN/CLOSE after stopping playing.

Playing an MD

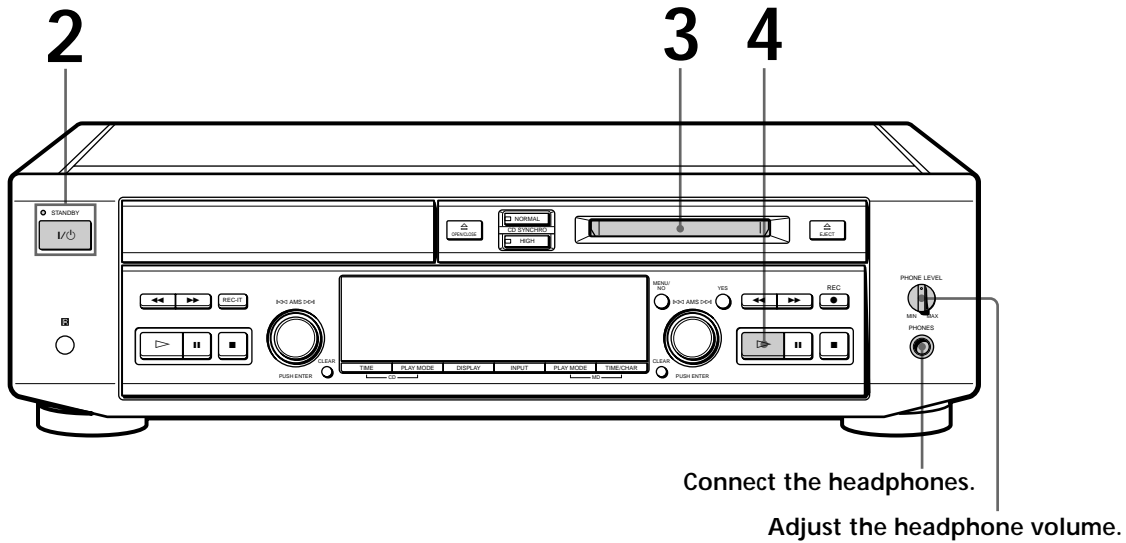

When using the controls on the deck
Use the MD deck controls located to the right of the front panel.

When using the remote
Set SELECT to MD.

Audio output
Output switches automatically to the audio of the MD.

You can start playing with the track selected in Step 4
1 Turn AMS (or press or) to select the track you want to play using the display*.
2 Press AMS or .

* See "Using the Display" on pages 10 and 11.

You can change the MD playback speed
See "Changing the Pitch of the MD" on page 16.

- 1** Turn on the amplifier and set the source selector to the position for this deck.
- 2** Press .
The STANDBY indicator turns off.

- 3** Insert an MD.

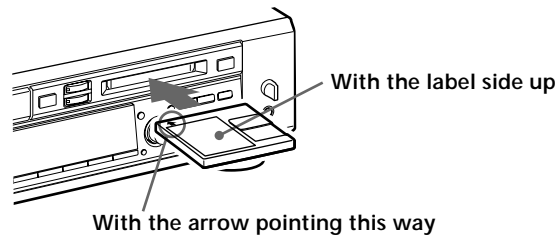

- 4** Press .
The deck starts playing. Adjust the volume on the amplifier.

To	Do the following:
Stop playing	Press .
Pause playing	Press . Press the button again or press to resume playing.
Go to the next track	Turn AMS clockwise (or press on the remote).
Go to the beginning of the current track or the preceding track	Turn AMS counterclockwise (or press on the remote).
Take out the MD	Press EJECT after stopping playing.

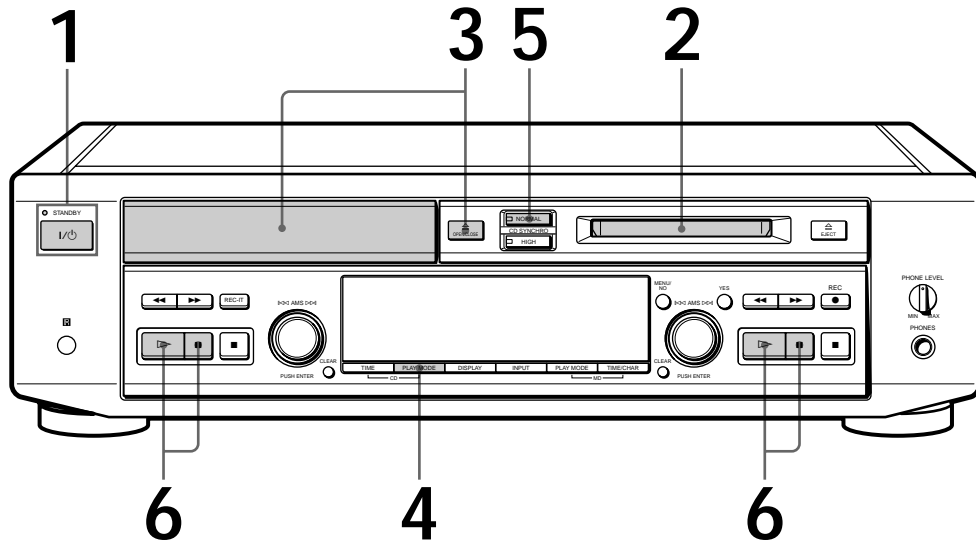

Recording a CD to an MD (CD Synchro-Recording)





You can easily make digital recordings from a CD to an MD, marking track numbers in the same sequence as the original CD.

Before recording, see “Notes on Recording” on page 17.

 **CD text is copied to the MD automatically**
When the CD to be recorded using the CD Synchro-Recording Function contains a disc name and track names, this information is recorded onto the MD automatically. If the MD is already labeled, only the track names are copied. Note that CD text on some CDs is copy-protected and thus may not be copied to the MD.

 **You can play back tracks just recorded**
If “TRACK” lights up in the display when recording has finished, press  immediately to play back from the first track of the material just recorded.

- 1** Press I/O.
The STANDBY indicator turns off.
- 2** Insert a recordable MD.
- 3** Press  OPEN/CLOSE to insert a CD. Press the button again to close the CD tray.
- 4** Select the playing mode of the CD (normal play, Program Play, or Repeat Play).
See “Playing CDs and MDs”.
- 5** Press CD SYNCHRO NORMAL.
“CD SYNCHRO” appears and “-Normal-” flashes in the display.
The MD deck section stands by for recording, and the CD player section stands by for playing.
- 6** After “CD SYNCHRO” and “-Normal-” turn off, press  or  on either left or right of the front panel.
Recording starts. The MD deck section and the CD player section will automatically stop after recording.

To stop recording

Press  to the right of front panel.

Notes

- You cannot record over existing material during CD Synchro-Recording. The deck automatically starts recording from the end of the existing material.
- Make sure that the remaining recordable time on the MD is longer than the playing time of the CD, especially if you want to record all the tracks on the CD.
- You cannot pause recording during CD Synchro-Recording.
- The recording level specified in the Setup Menu (page 20) is not applied during CD Synchro-Recording. The initial reference level (0.0 dB) is used instead.

When "TOC Writing" flashes in the display

The deck is currently updating the Table Of Contents (TOC). Do not move the deck or pull out the AC power cord. Changes to an MD made through recording are saved only when you update the TOC by ejecting the MD or changing the deck to standby by pressing the I/⏻ switch.

Do not disconnect the deck from the power source immediately after recording

If you do, recorded material may not be saved to the MD. To save the material, after recording, press \triangle EJECT to take out the MD or change the deck to standby by pressing I/⏻. "TOC Writing" will flash at this time. After "TOC Writing" goes out, you can pull out the AC power cord.

To protect an MD against accidental erasure

To make it impossible to record on an MD, slide the tab in the direction of arrow, opening the slot. To allow recording, close the slot.

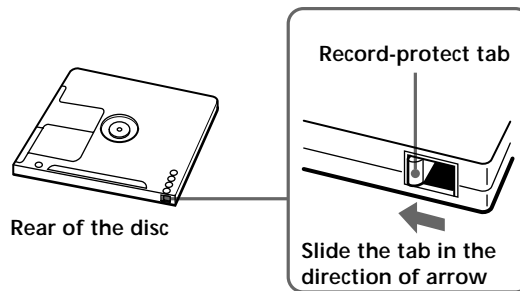

Using the Display

You can use the display to check disc and track information such as the total track number, total playing time of the tracks, track number and remaining time of the current track, remaining recordable time of the MD, and disc name.

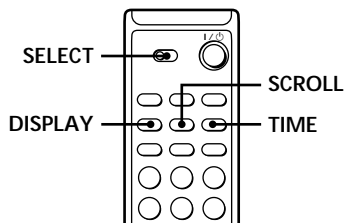
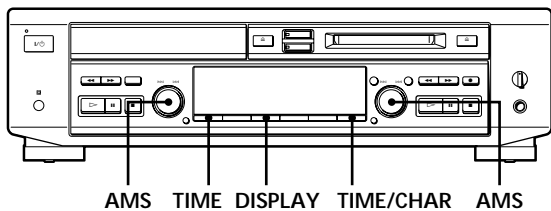

Changing the display

Each time you press DISPLAY while the deck is stopped or playing, you can change the display as follows:

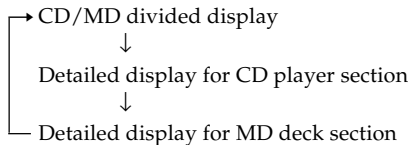

CD/MD divided display

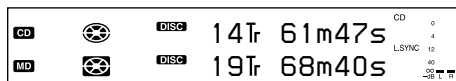

Detailed display for CD player section

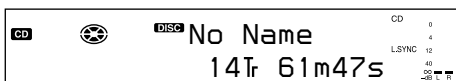

Detailed display for MD deck section

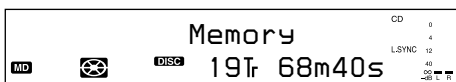

The display changes automatically

Whenever you change the operation status of the deck, the display automatically changes to reflect that status. For example, if you change to CD playback, details about CD playback, such as track number and playing time of the current track, will automatically appear.

The disc name and track names are displayed as follows

When either of the detailed display is selected, the disc name appears whenever the deck is stopped. The name of the current track appears when a track is playing. If the CD has no CD text information or no title is recorded on the MD, "No Name" appears instead. To label a recordable MD and its tracks, see "Labeling Recordings" on page 31.

You can scroll a title of 12 or more characters

Press SCROLL. Since the display shows up to 11 characters at a time, press SCROLL to see the rest of the title if the title has 12 characters or more. Press SCROLL again to pause scrolling, and again to continue scrolling.

To check the playing time of a track

Turn AMS while the deck is stopped to select the track. When the track number appears, its playing time is also displayed.

When or flashes in the display

The deck is reading information to be displayed. The original display will reappear after a little while.

Detailed display for CD player section

When using the remote, set SELECT to CD.

Checking the total number of tracks and total playing time of the CD

While the deck is stopped, the information appears as follows:

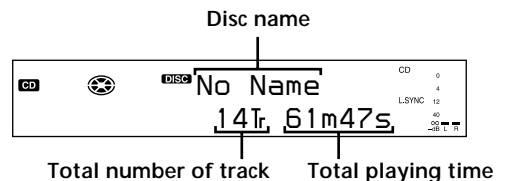

If you insert a CD containing CD TEXT data

"CD TEXT" lights up in the display.

Checking the track number and remaining time of the current track

Press TIME repeatedly while playing a CD.
Each time you press the button, the display changes as follows:

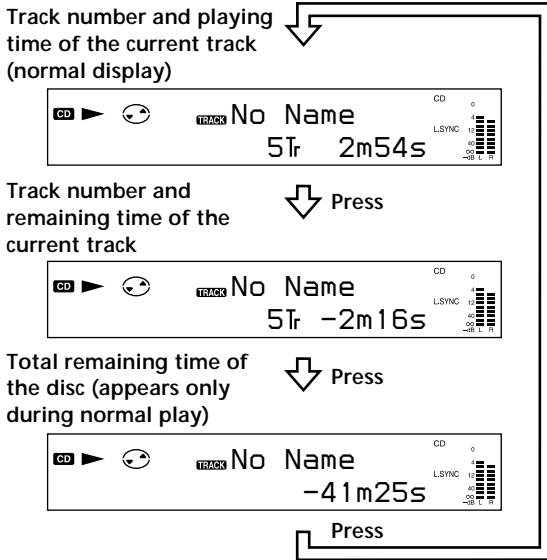

Detailed display for MD deck section

When using the remote, set SELECT to MD.

Checking the total track number, total disc playing time and remaining recordable time of the MD

Each time you press TIME/CHAR while the deck is stopped, you can change the display as follows:

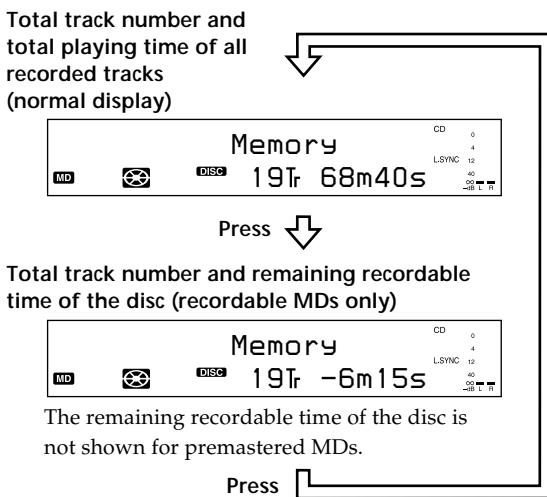

When you insert an MD, the disc name, total number of tracks and total disc playing time appear in the display as follows:

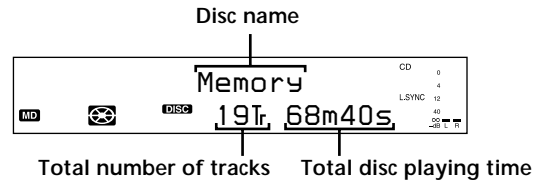

Checking the playing time, remaining time, and track number

Each time you press TIME/CHAR while playing an MD, you can change the display as follows:

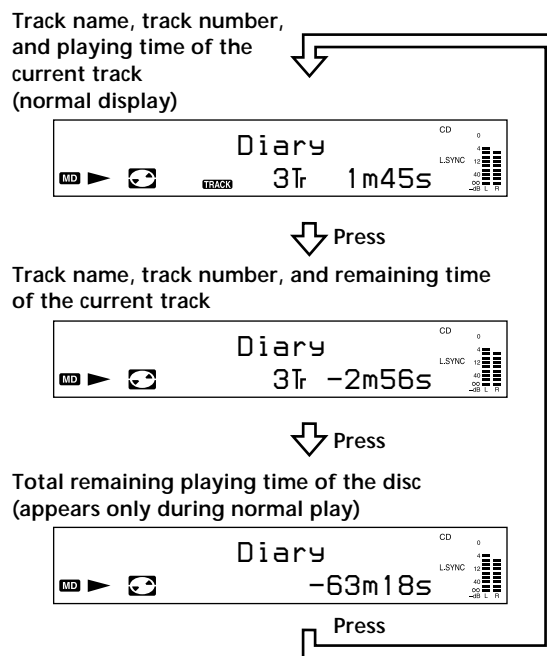

Locating a Specific Track

You can quickly locate any track while playing a disc by using the AMS (Automatic Music Sensor) control on the deck, **◀◀** and **▶▶** buttons on the remote, or number buttons on the remote.

When using the remote, set SELECT to CD or MD.

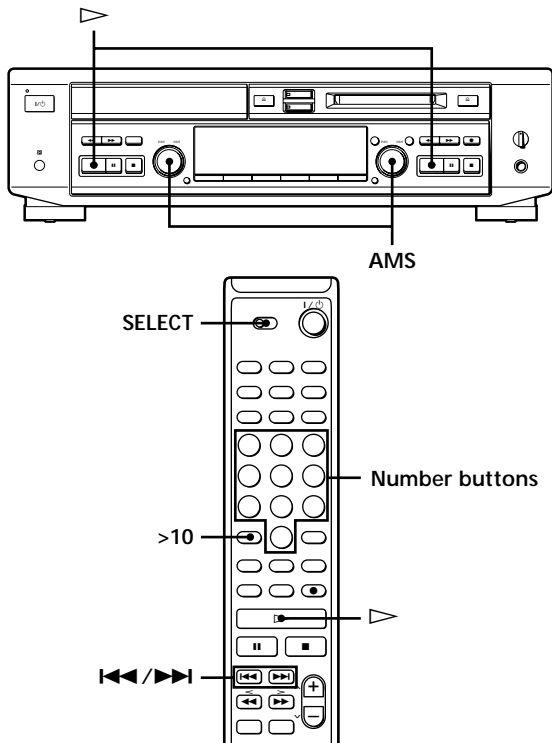

To locate	Do the following:
The next or succeeding tracks	During playback, turn AMS clockwise (or press ▶▶ repeatedly) until you find the track.
The beginning of the current or preceding tracks	During playback, turn AMS counterclockwise (or press ◀◀ repeatedly) until you find the track.
A specific track directly	Press number button(s) to enter the track number.
A specific track by using AMS	<ol style="list-style-type: none"> 1 While the deck is stopped, turn AMS until the track number you want to locate appears. 2 Press AMS or ▷.

When you directly locate a track with a number over 10

Press **>10** before entering the corresponding digits.
 Press **>10** once if it is a 2-digit track number, and twice if it is a 3-digit track number (for MD only).
 To enter "0", press button 10/0.

- Examples:
- To play track number 30
Press **>10** once, then 3 and 10/0.
 - To play track number 100
Press **>10** twice, then 1, 10/0 and 10/0.

To pause playing at the beginning of a track
 Turn AMS (or press **◀◀** or **▶▶**) after pausing playback.

To go quickly to the beginning of the last track
 Turn AMS counterclockwise (or press **◀◀**) while the display shows the total track number, total disc playing time or remaining recordable time of the disc (recordable MD only), or disc name (see page 11).

Locating a Particular Point in a Track

You can also use the **◀◀** and **▶▶** buttons to locate a particular point in a track during playback or playback pause.

When using the remote, set SELECT to CD or MD.

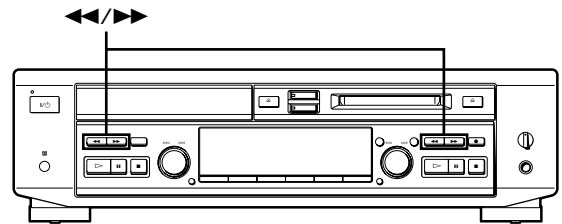

To locate a point	Keep pressing
While monitoring the sound	▶▶ (forward) or ◀◀ (backward) until you find the point.
Quickly by observing the display during playback pause	▶▶ or ◀◀ until you find the point. There is no sound output during this operation.

If "-- Over --" appears while you are pressing **▶▶**
 The disc has reached its end. Turn AMS counterclockwise (or press **◀◀**) or press **◀◀** to go back.

Notes



- If the disc reaches the end while you are pressing **▶▶** during sound monitoring, the deck stops.
- Tracks that are only a few seconds long may be too short to scan using the search function. For such tracks, it is better to play the disc at normal speed.

Adjusting the Output Level

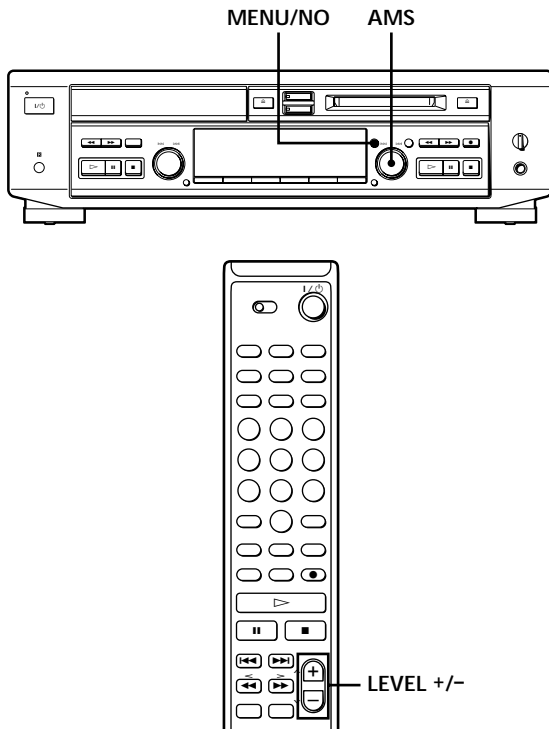
You can adjust the level of the playback signal output from the LINE (ANALOG) OUT and PHONES jacks.



- 1 While the deck is stopped, playing, or pausing, press MENU/NO twice to display "Setup Menu."
- 2 Turn AMS to select "Aout", then press AMS.
- 3 Turn AMS to change the output level within a range of 0.0 dB to -20.2 dB, then press AMS.
- 4 Press MENU/NO.

 You can also change the output level using the remote . During playback, press LEVEL +/- repeatedly. Note that the level cannot go above 0 dB or lower than -20.2 dB.

Note
The output level setting returns to the initial value (0.0 dB) when you turn off the deck or disconnect the AC power cord.

Playing Tracks Repeatedly (Repeat Play)

You can play tracks repeatedly in any play mode.

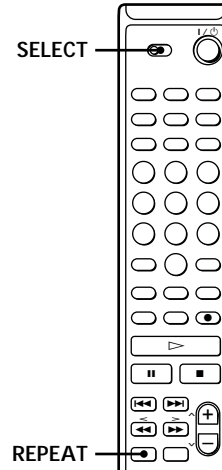

- 1 Set SELECT to CD or MD.
- 2 Press REPEAT repeatedly until "REPEAT" appears in the display.
The deck repeats the tracks as follows:

When the disc is played in	The deck repeats
Normal play (pages 6 and 7)	All the tracks
Shuffle Play (page 14)	All the tracks in random order
Program Play (page 14)	The same program

To stop Repeat Play
Press ■.

To cancel Repeat Play
Press REPEAT repeatedly until "REPEAT" disappears.

Repeating the current track only

While the track you want to repeat is playing in normal, Shuffle or Program Play, press REPEAT repeatedly until "REPEAT 1" appears in the display. If you select "REPEAT 1" while the deck is stopped, the deck repeats the next track that you locate to play.

Playing in Random Order (Shuffle Play)

You can have the deck “shuffle” tracks and play them in random order.

When using the remote, set SELECT to CD or MD.

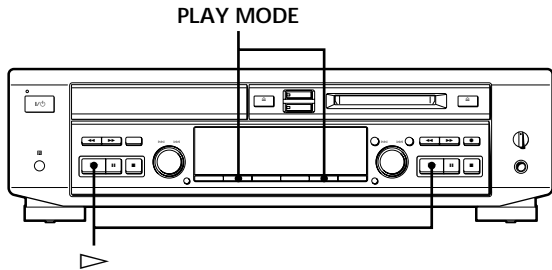

- 1 While the deck is stopped, press PLAY MODE repeatedly until “SHUFFLE” appears in the display.
- 2 Press ▶ to start Shuffle play. “- Shuffle -” or “” appears in the display while the deck is “Shuffling” the tracks.



To stop Shuffle Play

Press ■.

To cancel Shuffle Play

While the deck is stopped, press PLAY MODE repeatedly until “SHUFFLE” disappears.

You can specify tracks during Shuffle Play

- To play the next track, turn AMS clockwise (or press ).
- To play from the beginning of the current track again, turn AMS counterclockwise (or press ). You cannot use AMS (or ) to go back to tracks that have already been played.

Creating Your Own Program (Program Play)

You can specify the playback order of the tracks on a disc and create your own programs containing up to 25 tracks.

When using the remote, set SELECT to CD or MD.

Note

You cannot create a program containing tracks from both CD and MD.

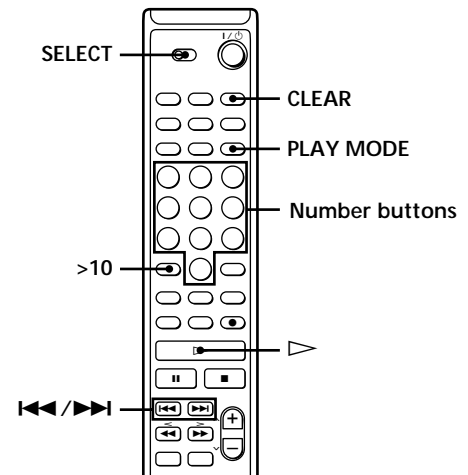
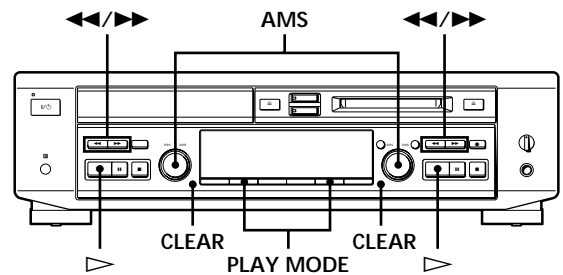

- 1 While the deck is stopped, press PLAY MODE repeatedly until “PROGRAM” appears in the display.

2 Do either **a)** or **b)** to create a program: “Program In” appears in the display for a few seconds at the beginning of either of the following procedures.

a) When using the controls on the deck

Turn AMS until the track number you want flashes in the display.
 Until you press the AMS control to enter the next track, you can continue turning the AMS to change the track selection. Furthermore, until you press ▷ to start Program Play, you can change any other track in the program (see “Changing the track order” on this page).

If you enter the wrong track number

Press ◀◀ or ▶▶ until the wrong track number flashes, then turn AMS to enter the correct track number.

b) When using the remote

Press the number buttons to enter the tracks you want to program in the order you want. To program a track with a number over 10, use the >10 button (see page 12).

If you enter the wrong track number

Press ◀◀ or ▶▶ until the wrong track number flashes, then enter the correct track number with the number buttons.

3 Press AMS, then repeat Step 2 to enter other tracks.
 Each time you enter a track, the total program time is added up and appears in the display.

4 Press ▷ to start Program Play.

To stop Program Play

Press ■.

To cancel Program Play

While the deck is stopped, press PLAY MODE repeatedly until “PROGRAM” disappears.

 **The program remains even after Program Play ends**

When you press ▷, you can play the same program again.

Notes

- The display shows “- -m - -s” instead of the total playing time when the total playing time of the program exceeds 199 minutes.
- “ProgramFull” appears when you program over 25 tracks. Erase the unnecessary tracks to enter other tracks.
- The program is erased when you turn off the deck or disconnect the AC power cord.

Changing the track order

You can change the order of the tracks in your program before you start playing.

To	Do the following:
Erase a track	Press ◀◀/▶▶ repeatedly until the number of the unwanted track flashes, then press CLEAR.
Erase all tracks	Press CLEAR repeatedly until all the track numbers disappear.
Add a track at the beginning of the program	Press ◀◀ repeatedly until the cursor flashes before the first track number, then do Step 2 above.
Add a track in the middle of the program	Press ◀◀/▶▶ repeatedly until the track number which will precede the new track flashes. Press AMS to display flashing cursor, then do Step 2 above.
Add a track to the end of the program	Press ▶▶ repeatedly until the cursor flashes after the last track number, then do Step 2 above.
Replace a track	Press ◀◀/▶▶ repeatedly until the number of the track to be changed flashes, then do Step 2 above.

 **You can check the playing time and title of a track before you add or erase it**

Press TIME or TIME/CHAR while the number of the track is flashing in the display. The playing time and the title of the track (if the track is labeled) will appear.

Falling Asleep to Music (Sleep Timer)

You can let the deck turn off after the specified time, so you can sleep to the music. You can specify the time until the deck turns off by 30 minutes.

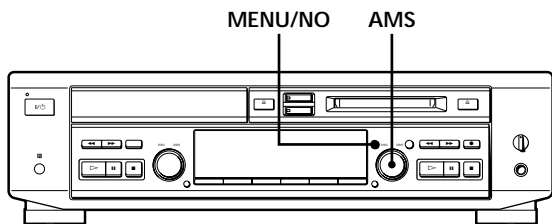

- 1 Press MENU/NO twice to display "Setup Menu."
- 2 Turn AMS to select "Sleep," then press AMS.
- 3 Turn AMS to select the time.
The minute display changes as follows:
Off ↔ 30 ↔ 60 ↔ 90 ↔ 120
- 4 Press AMS.
- 5 Press MENU/NO.

To change the time to turn off
Start over from Step 1 above.

To cancel the Sleep Timer Function
Start over from Step 1 above, selecting "Off" in Step 3.

 **After you activate the Sleep Timer Function**
The display dims.

 **You can check the time remaining until the deck turns off**
After specifying the time, do Step 1 above and turn AMS to select "Sleep." The time remaining appears to the right of "Sleep" indication.

Changing the Pitch of the MD (Pitch Control Function)

You can change the MD playback speed (pitch). The tone rises at higher pitches, and falls at lower pitches.

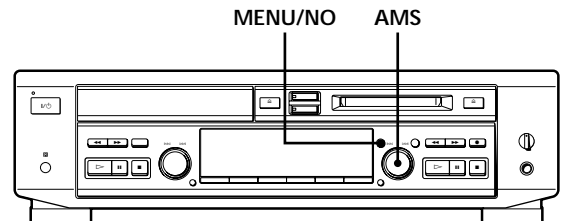

- 1 Press MENU/NO twice to display "Setup Menu."
- 2 Turn AMS to select "Pitch," then press AMS.
- 3 Turn AMS to change the pitch within a range of -98.5% to +12.5% (in 0.1% steps), then press AMS. When you press CLEAR, the setting returns to the initial value (0%).
- 4 Press MENU/NO.

Notes

- When you change the pitch during playback, the sound drops out momentarily.
- The pitch setting returns to the initial value (0%) when you turn off the deck or eject the MD.

Notes on Recording

If "Protected" and "C11" appear in the display

The MD is record-protected. Close the slot to record on the disc (see "To protect an MD against accidental erasure" on page 9).

If "Din Unlock" and "C71" alternate in the display

- The digital program source is not connected as you selected with the INPUT button in Step 3 on page 21. To continue, connect the program source properly.
- The program source is not on. Turn on the program source.

Depending on the Setup Menu settings and source being recorded, track numbers are marked in following ways:

- When recording from a CD or MD connected through the DIGITAL OPTICAL IN connector with OPT selected by the INPUT button:
The deck automatically marks track numbers in the same sequence as the original. If, however, a track is repeated two or more times (e.g. by single-track repeat play) or two or more tracks with the same track number (e.g. from different MDs or CDs) are played, the track or tracks are recorded as part of a single, continuous track with a single track number. If the source is an MD, track numbers may not be marked for tracks of less than 4 seconds.
- When recording from some CD players and multi disc players connected through the DIGITAL OPTICAL IN connector with "OPT" selected by the INPUT button:
The deck may not automatically mark track numbers. In these cases, mark the track numbers after recording, using the deck's DIVIDE Function (see "Dividing Recorded Tracks" on pages 28 and 29).
- When recording from a source connected through the LINE (ANALOG) IN jacks with "ANALOG" selected by the INPUT button or when recording from a DAT or satellite broadcast connected through the DIGITAL OPTICAL IN connector with "OPT" selected by the INPUT button and "T.Mark Off" is selected in Setup Menu:
The source will be recorded as a single track.

- Even while recording an analog source or a DAT or satellite broadcast, you can mark track numbers if "T.Mark LSyn" is selected in Setup Menu (see "Marking Track Numbers While Recording" on pages 21 and 22).
- When recording from DAT or satellite broadcasts with "OPT" selected by the INPUT button, the deck automatically marks a track number whenever the sampling frequency of the input signal changes regardless of track marking setting ("T.Mark LSyn" or "T.Mark Off").



You can mark track numbers during or after recording

For details, see "Marking Track Numbers While Recording" (pages 21 and 22) and "Dividing Recorded Tracks" (pages 28 and 29).

When "TOC Writing" flashes in the display

The deck is currently updating the Table Of Contents (TOC). Do not move the deck or pull out the AC power cord. Changes to an MD made through recording are saved only when you update the TOC by ejecting the MD or changing the deck to standby by pressing the I/⏻ switch.

The deck uses the SCMS (Serial Copy Management System on pages 39 and 40)

The contents of MDs recorded through digital input connector cannot be recorded by this deck through the DIGITAL OPTICAL IN connector.

Useful Tips for Recording

When using the remote, set SELECT to MD.

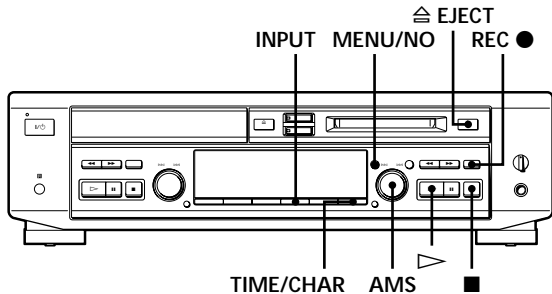

Checking the remaining recordable time on the MD

Press TIME/CHAR.

- When you press the button repeatedly while the deck is stopped, the display alternates between total disc playing time and remaining recordable time on the MD (see page 11).
- When you press the button repeatedly while recording, the display alternates between the recording time of the current track and the remaining recordable time on the MD.

Monitoring the input signal (Input Monitor)

Before starting recording, you can monitor the selected input signal through the deck's output jacks.

- 1 Press \triangle EJECT to remove the MD.
- 2 Press INPUT to select the input signal you want to monitor.
- 3 Press REC ●.

When "ANALOG" is selected

The input analog signal is output to the LINE (ANALOG) OUT jacks and the PHONES jack after A/D and D/A conversion.

"AD - DA" appears in the display at this time.

When "OPT" is selected

After passing through the Sampling Rate Converter (SRC), the digital signal input from the DIGITAL OPTICAL IN connector is output to the LINE (ANALOG) OUT jacks and PHONES jack after D/A conversion.

"- DA" appears in the display at this time.

To stop monitoring the signal

Press ■.

If "Auto Cut" appears in the display (Auto Cut)

There has been no sound input for about 30 seconds during recording. The 30 seconds of silence are replaced by a blank of about 3 seconds and the deck changes to recording pause.

If the deck continues pausing for about 10 minutes after the Auto Cut Function activated, recording stops automatically.

Note that this function does not activate even if there has been no sound input for about 30 seconds when the deck started recording from the blank portion.

Also, this function does not work when recording from the CD player section of this deck.

💡 You can turn off the Auto Cut Function

For details, see "To turn off the Smart Space Function and Auto Cut Function" below. Note that when you turn off the Auto Cut Function, the Smart Space Function is turned off automatically.

If "Smart Space" appears in the display (Smart Space)

There has been an extended silence of 4 to 30 seconds in length during recording. The silence is replaced with a blank of about 3 seconds and the deck continues recording. Note that new track numbers may not be marked for portions recorded while this function is activated. Also, the Smart Space Function does not activate even if there has been an extended silence of 4 to 30 seconds in length when the deck started recording from the blank portion.

Also, this function does not work when recording from the CD player section of this deck.

To turn off the Smart Space Function and Auto Cut Function

- 1 While the deck is stopped, press MENU/NO twice to display "Setup Menu."
- 2 Turn AMS to select "S.Space On," then press AMS.
- 3 Turn AMS to select "S.Space Off," then press AMS.
- 4 Press MENU/NO.

To turn on the Smart Space Function and Auto Cut Function again

- 1 Do Steps 1 and 2 in "To turn off the Smart Space Function and Auto Cut Function" above.
- 2 Turn AMS to select "S.Space On," then press AMS.
- 3 Press MENU/NO.

Notes

- When you turn off the Smart Space Function, the Auto Cut Function is also turned off automatically.
- The Smart Space Function and Auto Cut Function are factory set to on.
- If you turn off the deck or disconnect the AC power cord, the deck will recall the last setting (On or Off) of the Smart Space and Auto Cut Functions the next time you turn on the deck.

Recording on an MD Manually

You can start recording from the end of the existing material or record over the existing tracks just as you would on an analog cassette tape.

When using the remote, set SELECT to CD or MD.

To perform CD Synchro-Recording, see "Recording a CD to an MD" on pages 8 and 9 or "Recording a CD to an MD at High Speed" on page 23.

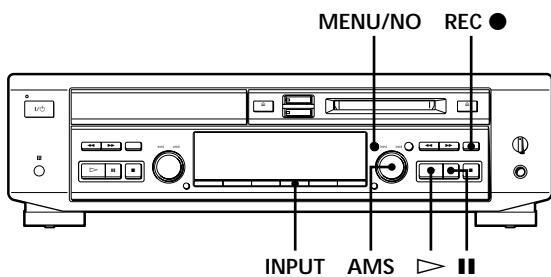

- 1 Turn on the amplifier and set the source selector to the position for the sound source you want to record.
- 2 Insert a recordable MD.
- 3 Press INPUT repeatedly to select the input connector.

To record through	Select
DIGITAL OPTICAL IN	OPT
LINE (ANALOG) IN	ANALOG

To record from the CD player section manually
Press INPUT repeatedly to select CD.

- 4 Press MENU/NO twice to display "Setup Menu."
- 5 Turn AMS to select "Stereo Rec," then press AMS.
- 6 Turn AMS to select the recording mode, then press AMS.

To record in	Select
Stereo	Stereo Rec
Monoaural	Mono Rec*

* In monoaural mode, the recording time is about two times longer than in stereo mode.

- 7 Press MENU/NO.
- 8 Decide a point on the MD where you want to start recording.

To record on a brand new MD or start recording from the end of the existing material
Skip this step.

To record from a specific point of a recorded track
Press ▷ to start playback, and press || at the point where you want to start recording.

To record erasing the previously recorded tracks
Turn AMS (or press ◀◀ or ▶▶ repeatedly) until the number of the track to be recorded over appears in the display.

- 9 Press REC ●.
The deck stands by for recording.
- 10 Adjust the recording level, if necessary.
For details, see "Adjusting the Recording Level" on page 20.
- 11 Press ▷ or ||.
Recording starts.
- 12 Start playing the sound source you want to record.

(Continued)

To pause recording

Press **II**. To resume recording, press the button again or press **▷**.

Note

Whenever you pause recording, the track number increases by one. For example, if you paused recording while recording on track 4, the track number increases by one and recording continues on the new track when restarted.

To stop recording

Press **■**.

💡 When "Overwrite" flashes in the display in Step 9 above

This indicates that the deck will start recording erasing the existing material.

💡 You can play back tracks just recorded

If "TRACK" lights up in the display when recording has finished, press **▷** immediately to play back from the first track of the material just recorded.

Notes

- You cannot record over the existing material when "PROGRAM" or "SHUFFLE" appears in the display.
- You cannot change the recording mode setting during recording or recording pause.
- You cannot operate the CD player section while the deck is recording or standing by for recording with "OPT" or "ANALOG" selected with the INPUT button.

Adjusting the Recording Level

You can adjust the recording level before starting recording.

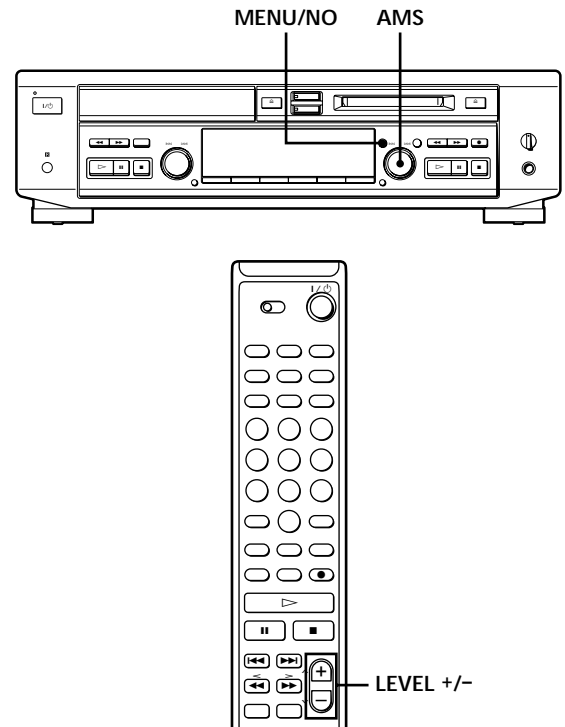

- 1 Do Steps 1 to 9 in "Recording on an MD Manually" on page 19.
- 2 Play the portion of the sound source with the strongest signal level.
- 3 Press MENU/NO twice to display "Setup Menu."
- 4 Turn AMS to select the program source.

To select	Turn AMS to display
CD player section of the deck	CD
a component connected to the DIGITAL OPTICAL IN connector	Opt
a component connected to the LINE (ANALOG) IN jacks	Ain

- 5 Press AMS.

- While monitoring the sound, turn AMS to adjust the recording level so that the OVER indication (red) of the peak level meters does not turn on, then press AMS.

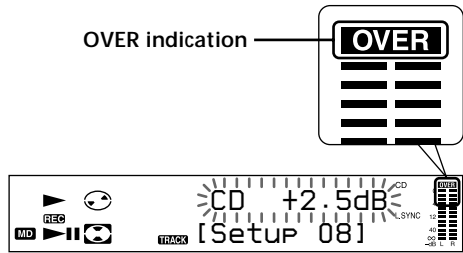

Recording level can be adjusted within a range of $-\infty$ to +12 dB.

- Press MENU/NO.
- Stop playing the sound source.
- To start recording, do the procedure starting from Step 11 in "Recording on an MD Manually" on page 19.

You can also change the recording level by using the remote . During recording pause, press LEVEL +/- repeatedly.

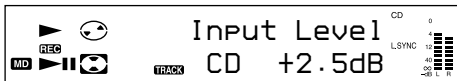

Note that the level cannot go above +12 dB.

Note
You cannot adjust the recording level while playing an MD.

Marking Track Numbers While Recording

You can mark track numbers either manually or automatically. By marking track numbers at specific points, you can quickly locate the points later using the AMS Function or Editing Functions.

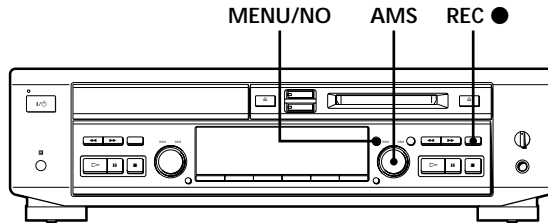

Marking track numbers manually

You can mark track numbers at any time while recording on an MD.

Press REC ● at the place you want to add a track mark while recording.

Marking track numbers automatically (Track Marking Function)

The deck adds track marks differently in the following cases:

- When recording from CDs or MDs with "OPT" selected by the INPUT button (when recording from a CD or MD connected through the DIGITAL OPTICAL IN connector):
The deck marks track numbers automatically according to the information contained in the source being recorded.
However, the deck may not automatically mark track numbers when recording from some CD players and multi disc players.
- When you make an CD Synchro-Recording (see pages 8 and 9) or High-Speed CD Synchro-Recording (see page 23), the deck marks track numbers automatically under the control of the CD player section.
- In all other cases:
If "T.Mark LSyn" is selected in Setup Menu, the deck marks a new track number whenever the signal drops to the specified level or below for about 1.5 seconds or longer, then rises to a specified level.

(Continued)

Set "T.Mark" in Setup Menu to "LSyn" or "Off" as follows:

- 1 Press MENU/NO twice to display "Setup Menu" while the deck is stopped.
- 2 Turn AMS to select "T.Mark LSyn," then press AMS.
- 3 Turn AMS to select "T.Mark LSyn" or "T.Mark Off," then press AMS.
If you select "T.Mark LSyn," "L.SYNC" lights up in the display.
- 4 Press MENU/NO.

Note

If you turn off the deck or disconnect the AC power cord, the deck will recall the last setting of the track marking function ("LSyn" or "Off") the next time you turn on the deck.

Recording the Current CD Track (REC-IT Function)

You can record specific tracks on a CD while listening to them. This function allows you to put only the tracks you like onto the MD.

When using the remote, set SELECT to CD.

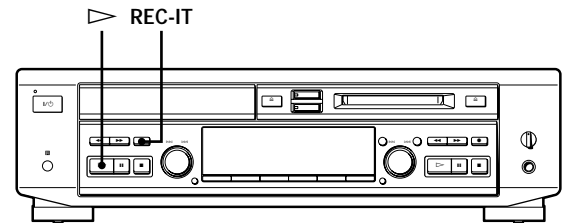

- 1 Press \blacktriangleright on the CD player section.
Make sure that the MD deck section is stopped.
- 2 Press REC-IT when you hear a track you want to record.
Play returns to the start of the track and recording starts. The recording stops at the end of the track, but CD playback continues from the next track.

To stop recording

Press \blacksquare on the CD player section.

Notes

- You cannot record over existing material during REC-IT Recording. The deck automatically starts recording from the end of the existing material.
- Make sure that the remaining recordable time on the MD is longer than the playing time of the CD track.
- The recording level specified in the Setup Menu (page 20) is not applied during REC-IT Recording. The initial reference level (0.0 dB) is used instead.

While "TOC Writing" is flashing

Do not move the deck or pull out the AC power cord to ensure the complete recording. The deck is currently updating the Table Of Contents (TOC) of the MD.

Recording a CD to an MD at High Speed (High-Speed CD Synchro-Recording)

This function allows you to record a CD to an MD at four times the speed of normal CD Synchro-Recording.

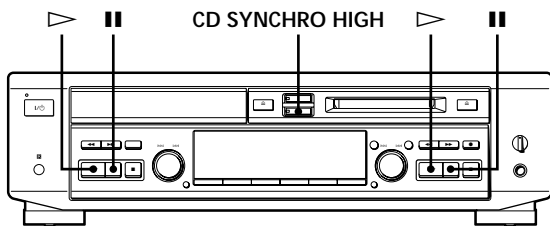

- 1 Insert a recordable MD.
- 2 Insert a CD that you want to record.
- 3 Select the playing mode of the CD (normal play, Program Play, or Repeat Play).
- 4 Press CD SYNCHRO HIGH.
“CD SYNCHRO” appears and “-High-” flashes in the display.
The MD deck section stands by for recording and the CD player section stands by for playing.
- 5 After “CD SYNCHRO” and “-High-” turn off, press ▷ or ■ on either CD player section or MD deck section.
High-speed recording starts. The deck stops automatically after recording.

Notes

- You cannot record over existing material during High-Speed CD Synchro-Recording. The deck automatically starts recording from the end of the existing material.
- Make sure that the remaining recordable time on the MD is longer than the playing time of the CD, especially if you want to record all the tracks on the CD.
- You cannot pause recording during High-Speed CD Synchro-Recording.
- The following items are either inoperative or cannot be used during High-Speed CD Synchro-Recording:
 - The Smart Space Function and Auto Cut Function.
 - The recording level specified in the Setup menu.
 - Recorded signal monitoring.
- With the following kinds of CDs, you may experience a reading failure or noise when recorded to an MD:
 - CDs with adhesive labels attached to them
 - Irregularly shaped CDs (for example, heart- or star-shaped)
 - CDs with printed text concentrated on one side only
 - Old CDs
 - Scratched CDs
 - Dirty CDs
 - Warped CDs
- If the following occurs during CD playback or recording, a reading error may occur or noise may be produced in the recorded results:
 - The CD tray or other part of the deck is bumped.
 - The deck is placed on an uneven or soft surface.
 - The deck is located near a speaker, door, or other source of vibration.

If “-Retry-” flashes in the display after you press ▷ or ■ in Step 5 above

A reading failure has occurred, and the deck is trying to read the data again.

- If the retry was successful, the deck continues with High-Speed CD Synchro-Recording.
- If the condition of the inserted CD or the deck is poor, and retry fails, High-Speed CD Synchro-Recording is disabled. In this case, the indicator on the CD SYNCHRO NORMAL button flashes and the deck automatically starts recording in normal CD Synchro-Recording. Note that monitoring of the recorded signal is not possible when this occurs.

To stop recording

Press ■ on the MD deck section.



You can label a track currently being recorded

You can use either the controls on the deck or the buttons on the remote (see pages 31 to 34).



You can play back tracks just recorded

If “TRACK” lights up in the display when recording has finished, press ▷ immediately to play back from the first track of the material just recorded.

Synchro-Recording With an External Audio Equipment (Music Synchro-Recording)

By using the MUSIC SYNC button on the remote, you can automatically start recording in sync with the signal input from the program source connected to the deck.

The method of marking track numbers differs, depending on the program source being recorded and the track marking setting (see “Notes on Recording” on page 17).

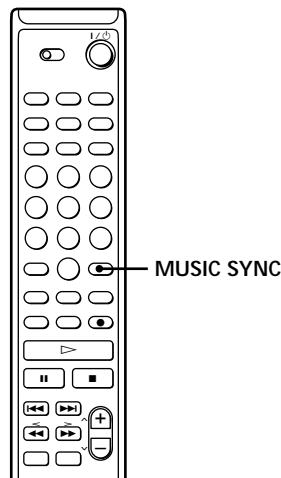

- 1 Do Steps 1 to 8 in “Recording on an MD Manually” on page 19.
In Step 3 on page 19, be sure to select OPT or ANALOG, but not CD. Note that Music Synchro-Recording is only for doing synchro-recording with an externally connected component.
- 2 Press MUSIC SYNC.
The deck changes to recording pause.
- 3 Start playing the program source you want to record.
The deck starts recording automatically.

To stop Music Synchro-Recording
Press .

Note
When Music Synchro-Recording, the Smart Space Function and the Auto Cut Function turn on automatically regardless of their setting (“On” or “Off”).

Starting Recording With Prestored Audio Data (Time Machine Recording)

When recording from an FM or satellite broadcast, the first few seconds of material are often lost due to the time it takes you to ascertain the contents and press the record button. To prevent the loss of this material, the Time Machine Recording Function constantly stores 6 seconds (12 seconds in monaural recording mode) of the most recent audio data in a buffer memory so that when you begin recording the program source using this function, the recording actually begins with the 6 seconds (or 12 seconds) of audio data stored in the buffer memory in advance as shown in the illustration below.

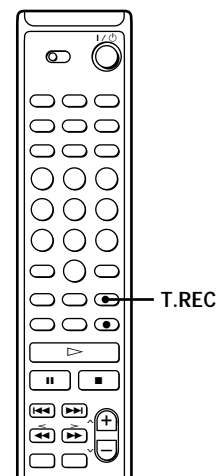
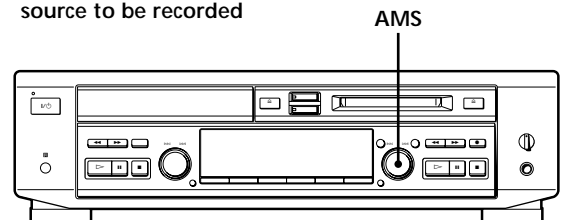
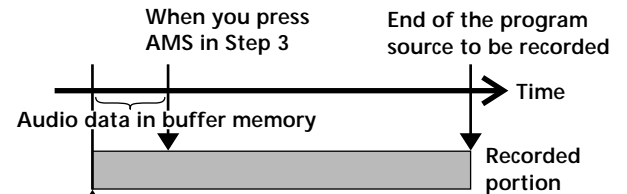

- 1 Do Steps 1 to 9 in “Recording on an MD Manually” on page 19.
The deck changes to recording pause.

- 2 Start playing the program source you want to record.
The most recent 6 seconds (12 seconds in monaural mode) of audio data is stored in the buffer memory.
- 3 Press AMS (or T.REC) to start Time Machine Recording.
Recording of the program source starts with the audio data stored in the buffer memory.

To stop Time Machine Recording

Press ■.

Note

The deck starts storing audio data when the deck is in recording pause and you start playing the program source. With less than 6 seconds (or 12 seconds) of playing of the program source and audio data stored in the buffer memory, Time Machine Recording starts with less than 6 seconds (or 12 seconds) of audio data.

Fading In and Out (Fader)

You can gradually increase the recording level at the beginning of a recording (fade-in recording) or gradually decrease the recording level at the end of a recording (fade-out recording).

This function is convenient when, for example, you don't want the track cut off abruptly when the disc reaches to its end.

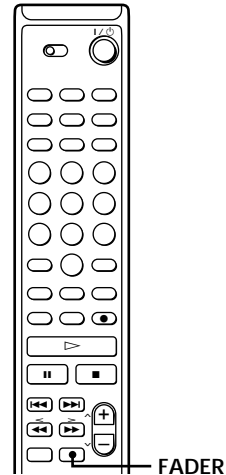

Fade-in recording

During recording pause, press FADER at the position where you want to start fade-in recording.

◀ flashes and the deck performs the fade-in recording until the counter reaches "0.0s."

Fade-out recording

During recording, press FADER at the position where you want to start fade-out recording.

▶ flashes and the deck performs the fade-out recording until the counter reaches "0.0s."

The deck changes to recording pause when fade-out recording finishes.

You can set the duration of fade-in and fade-out recording independently

- 1 While the deck is stopped, press MENU/NO twice to display "Setup Menu."
- 2 To set duration of fade-in recording:
Turn AMS to select "F.in," then press AMS.
To set duration of fade-out recording:
Turn AMS to select "F.out," then press AMS.
- 3 Turn AMS to set the duration.
Both the fade-in and fade-out recording duration can be set within a range of 1.0 second to 15.0 seconds (in 0.1-second steps).
- 4 Press AMS.
- 5 Press MENU/NO.

Notes on Editing

You can edit the recorded tracks after recording, using the following functions:

- Track Erase Function allows you to erase recorded tracks simply by specifying the corresponding track number.
- All Erase Function allows you to erase the contents of an entire MD.
- A-B Erase Function allows you to specify a portion within a track to erase it.
- Divide Function allows you to divide tracks at specified points so that you can quickly locate those points afterwards, using the AMS function.
- Combine Function allows you to combine two tracks into one.
- Move Function allows you to change the order of tracks by moving a specific track to a track position you want.
- Name Function allows you to create and edit titles for your recorded MDs and tracks.
- Undo Function allows you to cancel the last edit.

To enter Edit Menu

- 1 While the deck is stopped, playing, or pausing, press MENU/NO to display "Edit Menu."
- 2 Turn AMS to select the desired editing function, then press AMS.

If "Protected" or "Cannot Edit" appears in the display

The deck could not edit because the record-protect slot on the MD is open. Edit after closing the slot.

When "TOC" and "TOC Writing" flash in the display

Do not move the deck or pull out the AC power cord. After editing, "TOC" lights continuously until you eject the MD or turn off the deck. "TOC" and "TOC Writing" flash while the deck is updating the TOC. When the deck finishes updating the TOC, "TOC" and "TOC writing" turn off.

Erasing Recordings

Do the procedures below to erase following:

- A single track (Track Erase)
- All tracks (All Erase)

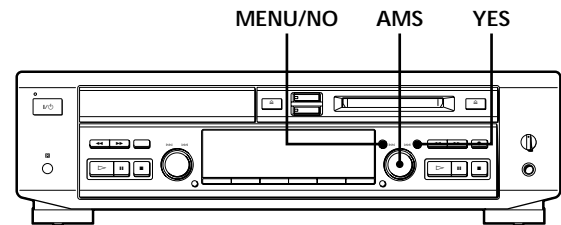

Erasing a single track (Track Erase Function)

You can erase a track simply by specifying the respective track number. When you erase a track, the total number of tracks on the MD decreases by one and all tracks following the erased one are renumbered. Since erasing merely updates the TOC, there is no need to record over material.

To avoid confusion when erasing multiple tracks, you should proceed in order of high to low track number to prevent the renumbering of tracks that have not been erased yet.

Example: Erasing B

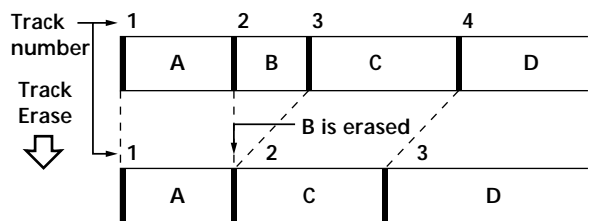

- 1 While the deck is stopped, playing, or pausing, press MENU/NO to display "Edit Menu."
- 2 Turn AMS until "Tr Erase ?" appears in the display.

- 3 Press AMS or YES.
The display for erasing tracks appears and playback of the displayed track starts.
- 4 Turn AMS to select the track to be erased.
- 5 Press AMS or YES.
When the track selected in Step 4 has been erased, "Complete!!" appears for a few seconds.
The track following the erased track begins playing. (If you erase the last track, the track preceding the erased track starts playing.)
- 6 Repeat Steps 1 to 5 to erase more tracks.

To cancel the Tr Erase Function

Press MENU/NO or ■.

Erasing all tracks on an MD (All Erase Function)

Erasing a recordable MD deletes the disc name, all recorded tracks, and titles.

- 1 While the deck is stopped, playing, or pausing, press MENU/NO to display "Edit Menu."
- 2 Turn AMS until "All Erase ?" appears in the display.
- 3 Press AMS or YES.
"All Erase??" appears in the display.
- 4 Press AMS or YES.
When the disc name, all recorded tracks, and titles on the MD have been erased, "Complete!!" appears for a few seconds.

To cancel the All Erase Function

Press MENU/NO or ■ to turn off the "All Erase??" indication.

- 💡 **You can undo the Tr Erase or All Erase Function**
Use the Undo Function immediately after you erased the track (see page 35).

Erasing a Part of a Track (A-B Erase Function)

You can specify a portion within a track and erase the portion with ease. It is convenient when erasing unnecessary sections after recording satellite broadcast or FM broadcast.

Example: Erasing a part of track A

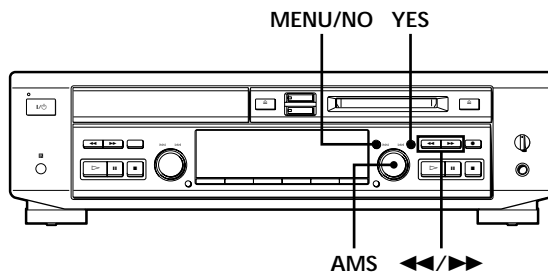
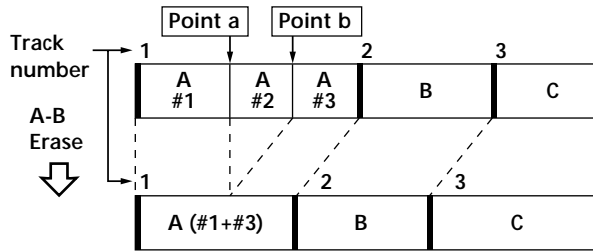

- 1 While the deck is stopped, playing, or pausing, press MENU/NO to display "Edit Menu."
- 2 Turn AMS until "A-B Erase ?" appears in the display, then press AMS or YES.
- 3 Turn AMS to select the number of the track, then press AMS or YES.
"-Rehearsal-" and "Point A ok?" alternate in the display while the deck plays back the selected track from the beginning.

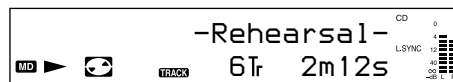

(Continued)

- 4 While monitoring the sound, turn AMS to find the starting point of the portion to be erased (point A).
You can select the unit ("f," "s," or "m") by which point A is shifted.
Press ◀ or ▶ to select frame* "f," second "s," or minute "m," then turn AMS to change point A.
* 1 frame is about 12 ms.
- 5 If point A is still incorrect, repeat Step 4 until it is correct.
- 6 Press AMS or YES if point A is correct.
"Point B set" appears in the display and playback for setting the end point of the portion to be erased (point B) starts.
- 7 Continue playback (or press ◀ or ▶) until the deck reaches point B, then press AMS or YES.
"-Rehearsal-" and "Point B ok?" alternate in the display while the deck repeats a portion of a few seconds before point A and after point B successively.
- 8 Repeat Step 4 if point B is not correct.
- 9 Press AMS or YES when point B is correct.
"Complete!!" appears for a few seconds and the portion between point A and B is erased.

To cancel the A-B Erase Function

Press MENU/NO or ■.

💡 You can undo the A-B Erase Function

Use the Undo Function immediately after you erased the part of the track (see page 35).

Note

If "Impossible" appears in the display, the specified portion cannot be erased.

This sometimes happens when you've edited the same track many times, and is due to a technical limitation of the MD system, not a mechanical error.

Dividing Recorded Tracks (Divide Function)

With the Divide Function you can mark a track number at places that you want to randomly access afterwards. Use this function to add tracks to MDs recorded from an analog source (and therefore contain no track numbers), or to divide an existing track into multiple portions for locating positions in the middle of a track. When you divide a track, the total number of tracks on the MD increases by one and all tracks following the divided track are renumbered.

Example: Dividing track 2 to create a new track for C

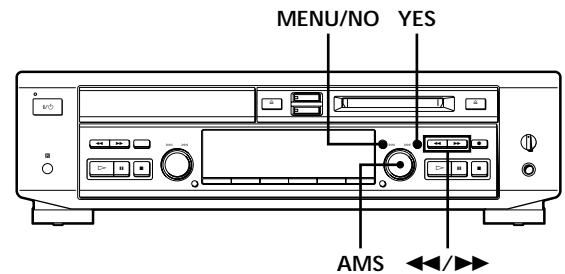
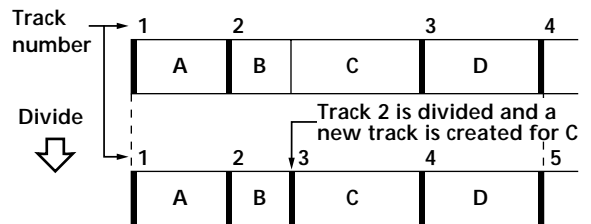

Dividing a track after selecting the track

- 1 While the deck is stopped, playing, or pausing, press MENU/NO to display "Edit Menu."
- 2 Turn AMS until "Divide ?" appears in the display, then press AMS or YES.
- 3 Turn AMS to select the track to be divided and press AMS or YES.
"-Rehearsal-" appears in the display and the deck plays back the selected track from the beginning.

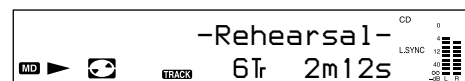

- 4 While monitoring the sound, turn AMS to find the point to divide the track.
You can select the unit ("f," "s," or "m") by which the point to divide the track is shifted.
Press ◀ or ▶ to select frame "f," second "s," or minute "m," then turn AMS to change the point to divide the track.
- 5 Press AMS or YES when the position is correct.
"Complete!!" appears for a few seconds and the newly created track begins playing. The new track will have no track title even if the original track was labeled.

To cancel the Divide Function

Press MENU/NO or ■.

 You can undo the Divide Function
Use the Undo Function immediately after you divided the track (see page 35).

 You can divide a track while recording
Mark the track numbers manually or use the Track Marking Function (see pages 21 and 22).

Dividing a track after selecting the dividing point

- 1 While playing the MD, press AMS at the point where you want to create a new track.
"- Divide -" and "-Rehearsal-" alternate in the display and playback continues from the position you selected.
- 2 To make fine adjustment on the dividing position, do Step 4 in "Dividing a track after selecting the track" on this page.
- 3 Press YES.
"Complete!!" appears for a few seconds and the newly created track begins playing.

To cancel the Divide Function

Press AMS, MENU/NO or ■.

Combining Recorded Tracks (Combine Function)

Use the Combine Function to combine tracks on a recorded MD. The two tracks to be combined need not be consecutive and the latter track to be combined can be the track which comes before the former one in the track number order. This function is useful for combining several songs into a single medley, or several independently recorded portions into a single track. When you combine two tracks, the total number of tracks decreases by one and all tracks following the combined tracks are renumbered.

Example: Combining B and D

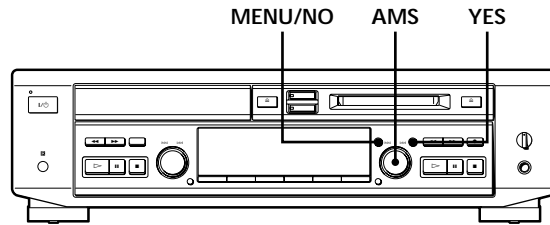
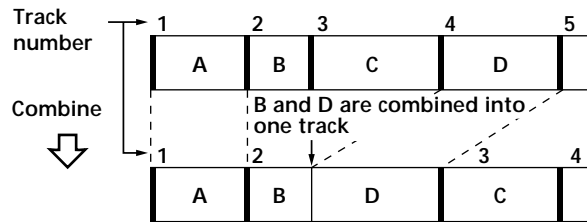

- 1 While the deck is stopped, playing, or pausing, press MENU/NO to display "Edit Menu."
- 2 Turn AMS to select "Combine ?," then press AMS or YES.

(Continued)

- Turn AMS to select the first track of the two to be combined and press AMS or YES. The display for selecting the second track appears and the deck repeats the portion where the two tracks will join (i.e., the end of the first track and the beginning of the succeeding track).

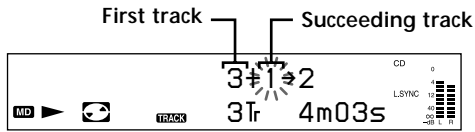

- Turn AMS to select the second track of the two to be combined and press AMS or YES. "Complete!!" appears for a few seconds. If both of the combined tracks have track titles, the title of the second track is erased.

To cancel the Combine Function
Press MENU/NO or ■.

- You can undo the Combine Function**
Use the Undo Function immediately after you combined the tracks (see page 35).

Note
If "Impossible" appears in the display, the tracks cannot be combined. This sometimes happens when you've edited the same track many times, and is due to a technical limitation of the MD system, not a mechanical error.

Moving Recorded Tracks (Move Function)

Use the Move Function to change the order of any track. After you move a track, the track numbers between the new and old track positions are automatically renumbered.

Example: Moving track C to track position 2

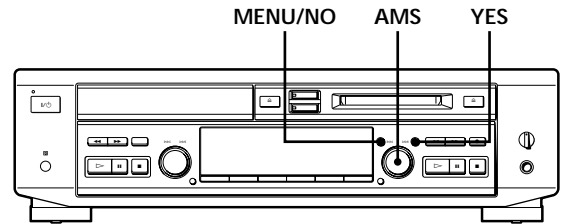
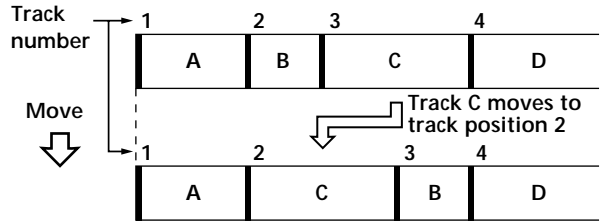

- While the deck is stopped, playing, or pausing, press MENU/NO to display "Edit Menu."
- Turn AMS to select "Move?," then press AMS or YES.
- Turn AMS to select the track to be moved and press AMS or YES.
- Turn AMS until the new track position appears. The deck plays the track to be moved during this time.

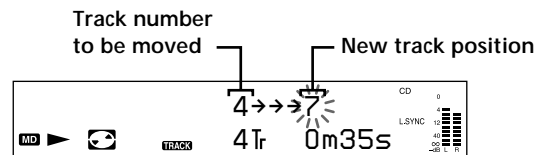

- 5 Press AMS or YES.
“Complete!!” appears for a few seconds and the moved track begins playing back.

To cancel the Move Function

Press MENU/NO or ■.

💡 You can undo the Move Function

Use the Undo Function immediately after you moved the track (see page 35).

Labeling Recordings (Name Function)

You can create titles for your recorded MDs and tracks. Titles — which may consist of uppercase and lowercase letters, numbers and symbols for a maximum of about 1,700 characters per disc — appear in the display during MD operation. You can also use the remote to label a track or an MD (see “Labeling tracks and MDs with the remote” on page 33).

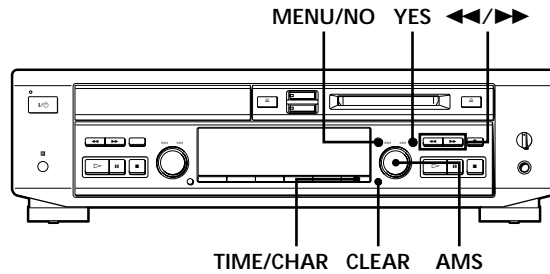

Use the following procedure to label a track or an MD. **You can label a track while it is playing, pausing, recording, or stopped. If the track is recording, be sure to finish labeling before the track ends. If the track ends before you’ve completed the labeling procedure, the characters already entered are not recorded and the track will remain unlabeled.**

- 1 Press MENU/NO to display “Edit Menu.”
- 2 Turn AMS until “Name ?” appears in the display and press AMS or YES.
Skip this step while recording.
- 3 Turn AMS until “Nm In ?” appears in the display, then press AMS or YES.
- 4 Turn AMS to select “Disc” to label an MD, or to specify the track to label.
While recording, go to Step 6.

(Continued)

- 5 Press AMS or YES.
A flashing cursor appears in the display.

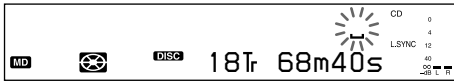

- 6 Press TIME/CHAR to select the character type as follows:

To select	Press TIME/CHAR repeatedly until
Uppercase letters	"A" appears in the display
Lowercase letters	"a" appears in the display
Numbers	"0" appears in the display
Symbols	"!" appears in the display

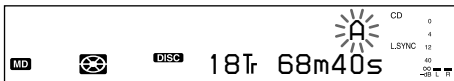

- 7 Turn AMS to select the character.
The selected character flashes.
Letters, numbers, symbols, and a space appear in sequential order as you turn AMS.
You can use the following symbols in titles:

! " # \$ % & ' () * + , - . / : ; < = > ? @ _ `

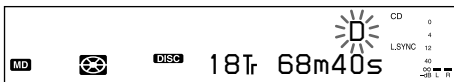

You can press TIME/CHAR to change the character type at any time during Step 7 (see Step 6 above).

- 8 Press AMS to enter the selected character.
The selected character stops flashing and the cursor flashes waiting for the input of the next character.

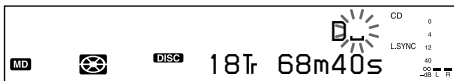

- 9 Repeat Steps 7 and 8 until you have entered the entire title.

If you entered the wrong character

Press ◀ or ▶ until the character to be corrected starts flashing, and repeat Steps 7 and 8 to enter the correct character.

To erase a character

Press ◀ or ▶ until the character to be erased starts flashing, then press CLEAR.

To enter a space*

Press AMS while the cursor is flashing.

* You cannot select a space for the first character of the title.

- 10 Press YES.
This completes the labeling procedure and the title appears in the display.

To cancel labeling

Press MENU/NO or ■.

Note

You cannot label a track or an MD while you are recording over an existing track.

Copying a track or disc title within an MD (Name Copy Function)

You can copy a track or disc title to use it as a title of another track or the disc title within a disc. Note that you can do this operation by using the controls on the deck only.

- 1 Press MENU/NO to display "Edit Menu."
- 2 Turn AMS to select "Name ?," then press AMS or YES.
- 3 Turn AMS to select "Nm Copy ?," then press AMS or YES.
- 4 Turn AMS to select "Disc" (when copying the disc title) or the track number (when copying the track title), and press AMS or YES to copy the selected title.

If "No Name" appears in the display

The disc or the track has no name.

- 5 Turn AMS to select "Disc" (when naming the disc) or the track number (when naming a track), and press AMS or YES to enter the copied title. "Complete!!" appears for a few seconds to indicate that the copying operation is completed.

If "Overwrite ?" appears in the display

The disc or track you selected already has a title. If you continue the title copying, press AMS or YES.

To cancel the Name Copy Function

Press MENU/NO or ■.

Labeling tracks and MDs with the remote

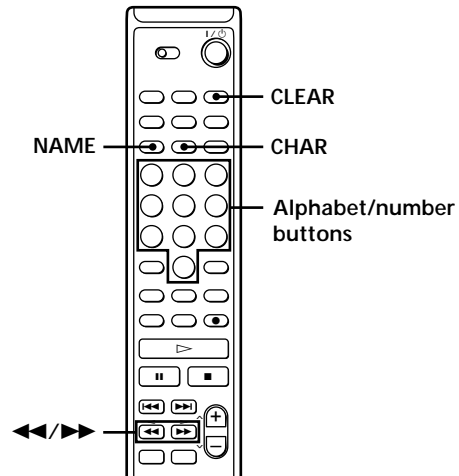

- 1 Press NAME. A flashing cursor appears in the display, then do the following:

To label	Make sure that the deck is
A track	Playing, pausing, recording the track to be labeled, or stopped after locating the track to be labeled
An MD	Stopped with no track number appearing in the display

- 2 Press CHAR repeatedly to select the character type as follows:

To select	Press CHAR repeatedly until
Uppercase letters	"Selected AB" appears in the display
Lowercase letters	"Selected ab" appears in the display
Numbers	"Selected 12" appears in the display

- 3 Press an alphabet/number button to enter a character.

If you selected uppercase or lowercase letters

- 1 Press the corresponding letter/number button repeatedly until the character to be entered flashes.
Or, press the button once and press ◀◀/▶▶ repeatedly.
- 2 Press ▶▶.
The flashing character is entered and lights continuously and the cursor shifts to the right.

(Continued)

- Repeat Steps 2 and 3 until you have entered the entire title.

If you entered the wrong character

Press ◀ or ▶ until the character to be corrected starts flashing.

Press CLEAR to erase the incorrect character, then enter the correct one.

To enter a space

Press ▶ while the cursor is flashing.

- Press NAME again.
This completes the labeling procedure and the title appears in the display.

To cancel labeling

Press MENU/NO or ■.

Changing an existing title

- Press NAME, then do the following:

To change	Make sure that the deck is
A track title	Playing, pausing the track whose title is to be changed, or stopped after locating the track whose title is to be changed
A disc name	Stopped with no track number appearing in the display

- Press down CLEAR until the current title is erased.
- Enter the new title.
Do Steps 6 to 9 of "Labeling Recordings" on page 32, or Steps 2 to 4 of "Labeling tracks and MDs with the remote" on page 33 and this page.
- Press NAME.

Erasing a title on a disc (Name Erase Function)

Use this function to erase a title on a disc.

- While the deck is stopped, playing, recording, or pausing, press MENU/NO to display "Edit Menu."
- Turn AMS to select "Name ?," then press AMS or YES.
- Turn AMS to select "Nm Erase ?," then press AMS or YES.

- Turn AMS to select "Disc" to erase the disc title, or the track whose title you want to erase and press AMS or YES.
"Complete!!" appears for a few seconds and the title is erased.

To cancel the Name Erase Function

Press MENU/NO or ■.

Erasing all titles on an MD (Name All Erase Function)

Use this function to erase all titles on an MD simultaneously.

- While the deck is stopped, playing, or pausing, press MENU/NO to display "Edit Menu."
- Turn AMS to select "Name ?," then press AMS or YES.
- Turn AMS to select "Nm AllErs?," then press AMS or YES.
"Nm AllErs??" appears in the display.
- Press AMS or YES again.
"Complete!!" appears for a few seconds and all titles are erased.

To cancel the Name All Erase Function

Press MENU/NO or ■.

 You can undo the Name Erase Function and the Name All Erase Function
See "Undoing the Last Edit" on page 35.

 You can erase all recorded tracks and titles
See "Erasing all tracks on an MD" on page 27.

Undoing the Last Edit (Undo Function)

You can use the Undo Function to cancel the last edit and restore the contents of the MD to the condition that existed before editing was done. Note, however, that you cannot undo an edit if you do any of the following after the edit:

- Press the REC ● button on the deck.
- Press the ● button or the MUSIC SYNC button on the remote.
- Update the TOC by turning off the deck or ejecting the MD.
- Disconnect the AC power cord.

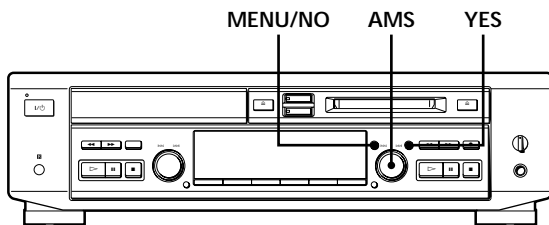

- 1 With the deck stopped and no track number appearing in the display, press MENU/NO to display "Edit Menu."
- 2 Turn AMS until "Undo ?" appears in the display. "Undo ?" does not appear if no editing has been done.
- 3 Press AMS or YES. One of the following messages appears in the display, depending on the type of editing to be undone:

Editing done	Message
Erasing a single track	
Erasing all tracks on an MD	"Erase Undo?"
Erasing a part of a track	
Dividing a track	"DivideUndo?"
Combining tracks	"CombinUndo?"
Moving a track	"Move Undo?"
Labeling a track or an MD	
Copying a title	
Changing an existing title	"Name Undo?"
Erasing a title	
Erasing all titles on an MD	

- 4 Press AMS or YES again. "Complete!!" appears for a few seconds and the contents of the MD are restored to the condition that existed before the edit.

To cancel the Undo Function

Press MENU/NO or ■.

Display Messages

The following table explains the various messages that appear in the display. Also, the deck has a Self-Diagnosis Function (see page 43).

Message	Meaning
Blank Disc	A new (blank) or erased MD has been inserted.
Cannot Copy	An attempt was made to make a second copy from a digitally dubbed MD (see page 39).
Cannot Edit	An attempt was made to edit the MD during Program or Shuffle Play or the MD is record-protected.
CD Error !!	An operational error has occurred in the CD player section. Wait a few seconds, and then try the operation again.
Disc Full!!	The MD is full (see "System Limitations" on this page).
Impossible	The deck cannot do the specified editing operation (see pages 26 to 34).
Name Full!!	The titling capacity of the MD has reached its limit (about 1,700 characters).
No Disc	There is no MD in the deck.
No Name	The disc or track has not been labeled.
Premastered	An attempt was made to record on the premastered MD.
ProgramFull	The program contains the maximum number of tracks. You cannot set additional tracks.
-Retry-	The deck is retrying reading data from the CD (see page 23).
Initialize (flashing when you turn on the deck)	This happens when the deck has been disconnected from the AC power source for certain period of time.

System Limitations

The recording system in your deck is radically different from those used in cassette and DAT decks and is characterized by the limitations described below. Note, however, that these limitations are due to the inherent nature of the MD recording system itself and not to mechanical causes.

"Disc Full!!" lights up even before the MD has reached the maximum recording time

When 255 tracks have been recorded on the MD, "Disc Full!!" lights up regardless of the total recorded time. More than 255 tracks cannot be recorded on the MD. To continue recording, erase unnecessary tracks or use another recordable MD.

"Disc Full!!" lights up before the maximum number of tracks is reached

Fluctuations in emphasis within tracks are sometimes interpreted as track intervals, incrementing the track count and causing "Disc Full!!" to light up.

The remaining recording time does not increase even after erasing numerous short tracks

Tracks under 12 seconds in length are not counted and so erasing them may not lead to an increase in the recording time.

Some tracks cannot be combined with others

Track combination may become impossible when tracks are edited.

The total recorded time and the remaining time on the MD may not total the maximum recording time

Recording is done in minimum units of 2 seconds each, no matter how short the material. The contents recorded may thus be shorter than the maximum recording capacity. Disc space may also be further reduced by scratches.

Tracks created through editing may exhibit sound dropout during search operations.

Track numbers are not recorded correctly

Incorrect assignment or recording of track numbers may result when CD tracks are divided into several smaller tracks during digital recording. Also, when the Track Marking Function is activated during recording, track numbers may not be marked as in the original depending on the program source.

“TOC Reading” appears for a long time

If the inserted recordable MD is brand new, “TOC Reading” appears in the display longer than for MDs that have been used.

Limitations when recording over an existing track

- The correct remaining recording time may not be displayed.
- You may find it impossible to record over a track if that track has been recorded over several times already. If this happens, erase the track using the Tr Erase Function (see pages 26 and 27).
- The remaining recording time may be shortened out of proportion to the total recorded time.
- Recording over a track to eliminate noise is not recommended since this may shorten the duration of the track.
- You may find it impossible to label a track while recording over it.

The correct recorded/playing time may not be displayed during playback of monaural-format MDs.

Troubleshooting

If you experience any of the following difficulties while using the deck, use this troubleshooting guide to help you remedy the problem.

CD player section

The player does not start playing.

- ➔ Insert a CD.
- ➔ Place the CD properly.
- ➔ Clean the CD.
- ➔ Moisture condensation has formed inside the deck. Take the CD out and leave the deck turned on for about an hour until the moisture evaporates.

MD deck section

The deck does not operate or operates poorly.

- ➔ The MD may be damaged (“Disc Error!!” appears). Take the MD out and insert it again. If “Disc Error!!” remains, replace the MD.

The deck does not play back.

- ➔ Moisture has formed inside the deck. Take the MD out and leave the deck in a warm place for several hours until the moisture evaporates.
- ➔ Press I/⏻ to turn the deck on.
- ➔ Slide the MD into the disc slot with the label side up and the arrow pointing towards the opening.
- ➔ Replace the disc with one that has been recorded.

The deck does not record.

- ➔ The MD is record-protected (“Protected” appears and “C11” flashes). Close the record-protect slot (see page 9).
- ➔ Make connections properly to the sound source.
- ➔ The sound source is not connected to the selected input connector. Select the correct input connector using INPUT.
- ➔ The recording level is not adjusted properly. Adjust the recording level properly (see pages 20 and 21).
- ➔ A premastered MD is inserted. Replace it with a recordable MD.
- ➔ There is not enough time left on the MD. Replace it with another recordable MD with fewer recorded tracks, or erase unnecessary tracks.
- ➔ There has been a power failure or the AC power cord has been disconnected during recording. Data recorded to that point may be lost. Repeat the recording procedure.

The sound has a lot of static.

- ➔ Strong magnetism from a television or a similar device is interfering with operations. Move the deck away from the source of strong magnetism.

The three-digit display appears.

- ➔ The Self-Diagnosis Function is on. Check the table on page 43.

Others

No sound is output.

- ➔ Make the connections properly.
- ➔ Operate the amplifier properly.
- ➔ When using the headphones, turn PHONE LEVEL to turn up the output level.

The remote does not operate the deck.

- ➔ Make sure that there is no obstacles between the deck and the remote.
- ➔ Point the remote at the remote sensor on the deck.
- ➔ Replace the batteries in the remote.

After you’ve attempted the prescribed remedies

If the deck still does not operate properly, or if other problems not described above occur, turn off the deck, then reinsert the plug into the power outlet.

If the problem persists, reset the system as follows:

- 1 Turn off the deck and unplug the AC power cord.
- 2 Reinsert the plug into the power outlet while pressing down I/⏻.

Should any problem persist even after resetting the system, consult your nearest Sony dealer.

Specifications

CD player section

System	Compact Disc digital audio system
Laser	Semiconductor laser ($\lambda = 780 \text{ nm}$) Emission duration: continuous
Laser output	Less than 44.6 μW^* * This output is the value measured at a distance of 200 mm from the objective lens surface on the Optical Pick-up Block with 7 mm aperture.
Frequency response	5 to 20,000 Hz $\pm 0.5 \text{ dB}$
Signal-to-noise ratio	More than 98 dB
Wow and flutter	Below measurable limit

MD deck section

System	MiniDisc digital audio system
Disc	MiniDisc
Laser	Semiconductor laser ($\lambda = 780 \text{ nm}$) Emission duration: continuous
Laser output	Less than 44.6 μW^* * This output is the value measured at a distance of 200 mm from the objective lens surface on the Optical Pick-up Block with 7 mm aperture.
Laser diode properties	Material: GaAlAs
Revolutions (CLV)	800 rpm to 1,800 rpm
Error correction	Advanced Cross Interleave Reed Solomon Code (ACIRC)
Sampling frequency	44.1 kHz
Coding	Adaptive Transform Acoustic Coding (ATRAC)
Modulation system	EFM (Eight-to-Fourteen Modulation)
Number of channels	2 stereo channels
Frequency response	5 to 20,000 Hz $\pm 0.5 \text{ dB}$
Signal-to-noise ratio	Over 98 dB during playback
Wow and flutter	Below measurable limit

Inputs

	Jack type	Input impedance	Rated input	Minimum input
LINE (ANALOG) IN	Phono jacks	47 kilohms	500 mVrms	125 mVrms
DIGITAL OPTICAL IN	Square optical connector jack	Optical wave length: 660 nm	—	—

Outputs

	Jack type	Rated output	Load impedance
PHONES	Stereo phone jack	10 mW	32 ohms
LINE (ANALOG) OUT	Phono jacks	2 Vrms (at 50 kilohms)	Over 10 kilohms

General

Power requirements

Where purchased	Power requirements
U.S.A. and Canada	120 V AC, 60 Hz
Europe	220 - 230 V AC, 50/60 Hz
Certain countries in Asia	220 - 240 V AC, 50/60 Hz
Other countries	110 - 120 or 220 - 240 V AC selectable, 50/60 Hz

Power consumption

Where purchased	Power consumption
U.S.A. and Canada	20 W (less than 1 W at standby)
Europe	20 W (less than 1 W at standby)
Other countries	22 W (less than 1.2 W at standby)

Dimensions (approx.) (w/h/d) incl. projecting parts and controls

430 × 120 × 290 mm

Mass (approx.) 4.7 kg

Supplied accessories

See page 4.

US and foreign patents licensed from Dolby Laboratories Licensing Corporation.

Design and specifications are subject to change without notice.

Guide to the Serial Copy Management System

This MD deck uses the Serial Copy Management System, which allows only first-generation digital copies to be made of premastered software via the deck's digital input jack. An outline of this system appears below:

- 1 You can record from digital program sources (CDs, DATs or premastered MDs) onto a DAT tape or recordable MD via digital input jack on the DAT or MD deck. You cannot, however, record from this recorded DAT tape or MD onto another DAT tape or recordable MD via the digital input jack on the DAT or MD deck.

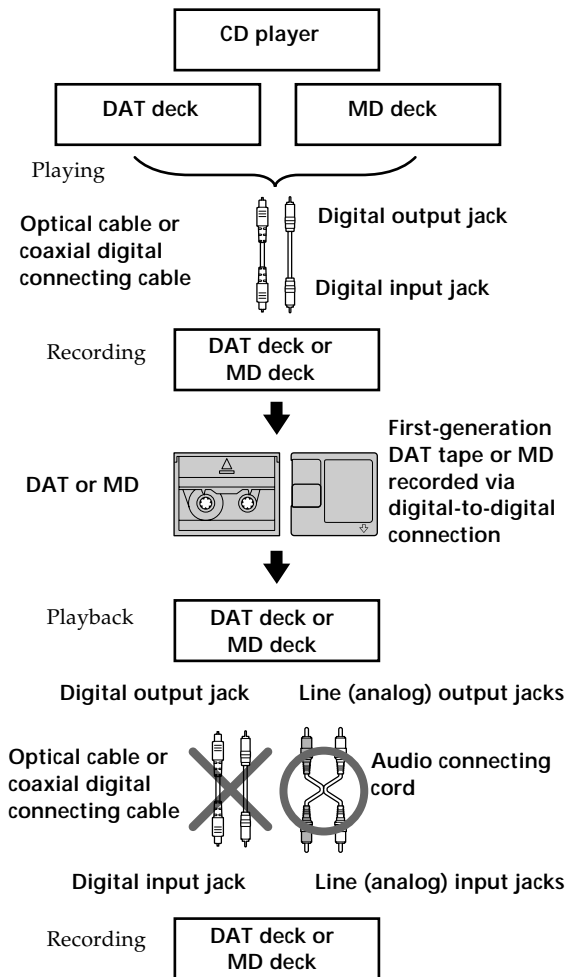

- 2 You can record the digital input signal of a digital satellite broadcast onto a DAT tape or recordable MD via the digital input jack on the DAT or MD deck which is capable of handling a sampling frequency of 32 kHz or 48 kHz. You can then record the contents of this recorded DAT tape or MD (first-generation) onto another DAT tape or recordable MD via digital input jack on the DAT or MD deck to create a second-generation digital copy. Subsequent recording from the second-generation copy onto another recordable DAT tape or MD is possible only through the analog input jack on the DAT or MD deck. Note, however, that on some BS/CS tuners, second-generation digital copying may not be possible.

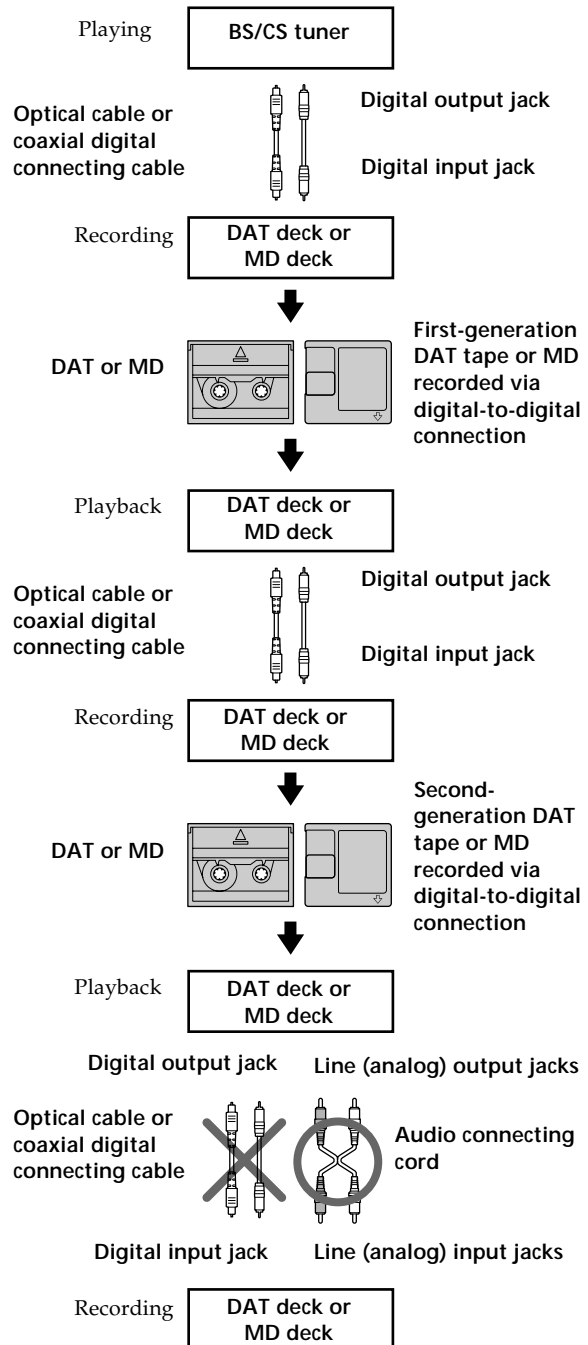

(Continued)

Additional Information

- 3 You can record a DAT tape or MD recorded via the DAT or MD deck's analog input jack onto another DAT tape or MD deck via the DAT or MD deck's digital output jack. You cannot, however, make a second-generation DAT tape or MD copy via the DAT or MD deck's digital output jack.

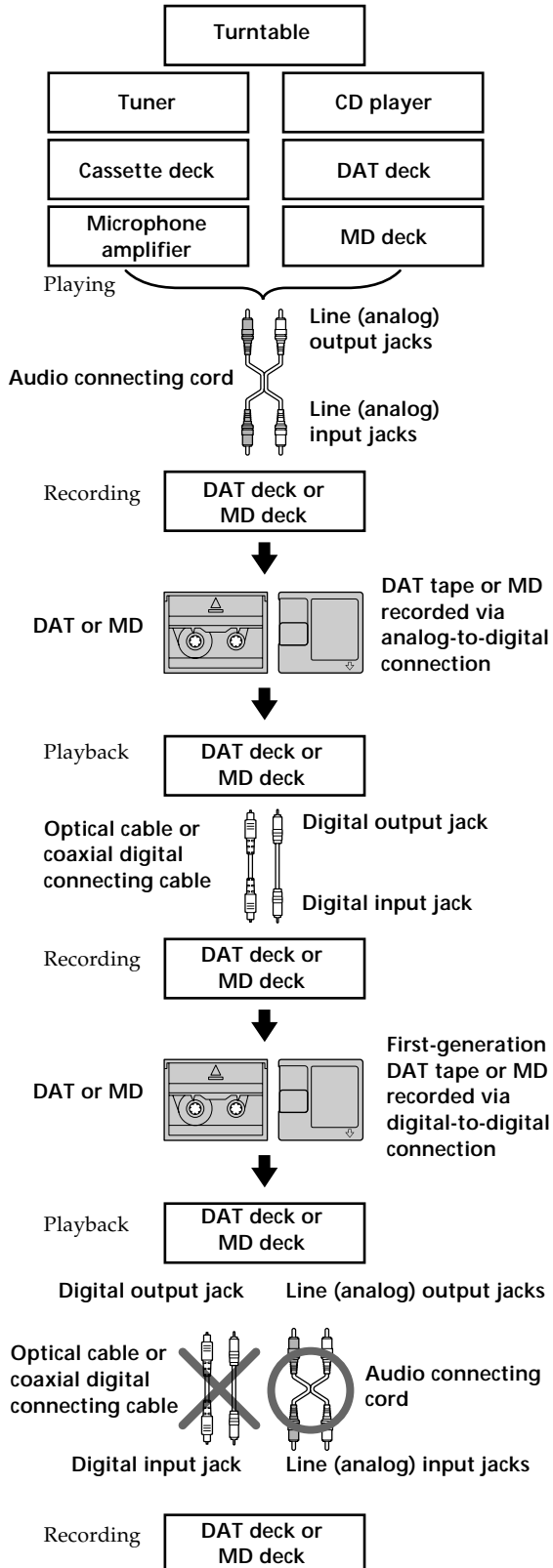

Index

A, B

- Adjusting
 - output level 13
 - recording level 20
- AMS (Automatic Music Sensor) 12
- Audio connecting cord 4, 5, 39, 40
- Auto cut 18

C

- CD
 - inserting 6, 8
 - taking out 6, 9
 - text 8
- Changing
 - an existing title 34
 - display 10
 - order of programmed tracks 15
- Checking
 - remaining time 10, 11, 18
 - playing time 10, 11
 - total number of tracks 10, 11
 - track name 11
 - track number 10, 11
- Cleaning 2
- Combining 30

D

- Display messages 36
- Dividing
 - after selecting the dividing point 29
 - after selecting the track 28

E

- Erasing
 - all titles 34
 - all tracks 27
 - a part of a track 27
 - a single track 26
 - a title 34

F, G

- Fade-in recording 25
- Fade-out recording 25

H

- Hooking up
 - a digital component 5
 - an analog component 5

I, J, K

- Input monitor 18

L

- Labeling
 - an MD 31
 - a track 31
 - copying a title within an MD 33
 - with the remote 33
- Locating
 - a particular point in a track 12
 - a specific track 12

M, N

- MD
 - inserting 7, 8
 - premastered 11, 36
 - recordable 8
 - taking out 7, 9
- Moving 30

O

- Optical cable 4, 5, 39, 40

P, Q

- Pitch control 16
- Playing
 - CD 6
 - MD 7
 - normal play 6, 7
 - program play 14
 - repeat play 13
 - shuffle play 14

R

- Recording
 - CD synchro-recording 8
 - erasing tracks 20
 - high-speed CD synchro-recording 23
 - manual recording 19
 - music synchro-recording 24
 - REC-IT function 22
 - time machine recording 24
- Recording mode 20
- Record-protect tab 9
- Remote commander (remote) 4

S

- Sampling frequency 5, 38, 39
- Sampling rate converter 5, 18
- SCMS (Serial Copy Management System) 17, 39
- Self-diagnosis 43
- Setup Menu 42
- Sleep Timer 16
- Smart space 18
- Specifications 38
- Supplied accessories 4
- System limitations 36

T

- Track marking
 - automatic track marking 21
 - manual track marking 21
- Troubleshooting 37

U, V, W, X, Y, Z

- Undoing the last edit 35

Names of controls

Buttons

- Alphabet/Number 12, 14, 33
- CD SYNCHRO HIGH 23
- CD SYNCHRO NORMAL 8
- CHAR 33
- CLEAR 14, 31, 33
- DISPLAY 10
- ⏏ EJECT 7, 9, 18
- FADER 25
- INPUT 18, 19
- LEVEL +/- 13, 20
- MENU/NO 13, 16, 18 to 21, 26 to 31, 34
- MUSIC SYNC 24
- NAME 33
- ⏏ OPEN/CLOSE 6, 8, 9
- PLAY MODE 14
- (REC) (recording) 18, 19, 21
- REC-IT 22
- REPEAT 13
- SCROLL 10
- TIME(/CHAR) 10, 18, 31
- T.REC 24
- YES 26 to 31, 34
- ▷ (play) 6 to 9, 12, 14, 18, 19, 22, 23
- ⏏ (pause) 6 to 9, 19, 23
- (stop) 6, 7, 9, 18
- ◀◀/▶▶ (manual search) 12, 14, 27, 28, 31, 33
- ◀◀/▶▶| (AMS: Automatic Music Sensor) 6, 7, 12, 14 >10 12, 14

Connectors

- DIGITAL OPTICAL IN 5, 20, 38

Controls

- AMS 6, 7, 10, 12 to 14, 16, 18 to 21, 24, 26 to 31, 34
- PHONE LEVEL 6, 7

Indicators

- STANDBY 6 to 8

Jacks

- LINE (ANALOG) IN/OUT 5, 20, 38
- PHONES 6, 7, 38

Switch

- SELECT 6, 7, 10, 12 to 14, 19
- I/⏏ (power) 6 to 8

Others

- Display 10, 11
- TOC 26
- TOC Writing 9, 17, 27
- 📺 4

Table of Setup Menus

You can make various settings on this deck by using Setup Menus. Operation related to each menu were explained in the previous sections. The table below outlines each menu, including the various parameters and initial settings.

Note

The menus you can use while the deck is stopped, playing or recording differ.

To enter the Setup Menu

While the deck is stopped, press MENU/NO twice to display "Setup Menu."

Menu	Function	Parameters	Initial setting	See
T.Mark	Sets the Track Marking Function.	LSyn/Off	LSyn	page 22
S.Space	Sets the Smart Space and Auto Cut Functions.	On/Off	On	pages 18 and 19
F.in	Sets the fade-in time.	1.0s to 15.0s	5.0s	page 25
F.out	Sets the fade-out time.	1.0s to 15.0s	5.0s	page 25
Pitch	Sets the pitch during MD playback.	-98.5% to +12.5%	0.0%	page 16
Sleep	Sets the Sleep Timer Function.	120/90/60/30/Off	Off	page 16
Rec	Sets the recording mode.	Stereo/Mono	Stereo	page 20
CD	Adjusts the input level from the CD player section.	-∞dB to +12.0dB	0.0dB	page 20
Opt	Adjusts the input level from the DIGITAL OPTICAL IN connector.	-∞dB to +12.0dB	0.0dB	page 20
Ain	Adjusts the input level from the LINE (ANALOG) IN jacks.	-∞dB to +12.0dB	0.0dB	page 20
Aout	Adjusts the output level from the LINE (ANALOG) OUT jacks.	-20.2dB to 0.0dB	0.0dB	page 13

To reset to the initial setting

Press CLEAR while the respective Setup Menu is displayed.

Self-Diagnosis Function

The deck has a self-diagnosis display. This function shows a three-digit display (a combination of a letter and figures) and the corresponding message, so you can check the deck's condition.

If such a display appears, check the following table in order to resolve the problem.

Should any problem persist, consult your nearest Sony dealer.

Three-digit display/Message	Cause/Remedy
C11/Protected!!	The inserted MD is record-protected. ➔ Take out the MD, and close the record-protect tab (page 9).
C12/Cannot Copy	An attempt was made to play a disc that is not compatible with this deck (CD-ROM, MD data disc, etc.). ➔ Replace the disc.
C13/REC Error!!	The recording was not made properly. ➔ Set the deck in a stable place, and repeat the recording procedure.
	The inserted MD is dirty (with smudges, fingerprints, etc.), scratched, or not up to standards. ➔ Replace the disc, and repeat the recording procedure.
C13/Disc Error!!	The deck could not read the TOC of the MD properly. ➔ Take out the MD, and insert it again.
C13/Read Error	The deck could not read the TOC of the MD properly. ➔ Eject the disc, then insert it again.
C14/TOC Error!!	The deck could not read the TOC of the MD properly. ➔ Insert another disc. ➔ If possible, erase all tracks on the MD using the All Erase Function on page 27.
C41/Cannot Copy	The digitally dubbed material cannot be recorded digitally (page 39).
C71/Din Unlock ("C71" alternates with "Din Unlock" in the display.)	A moment's lighting is due to the signals of the digital program being recorded. This does not affect the recorded material. While recording from a digital component connected through the DIGITAL OPTICAL IN connector, the digital connecting cable was unplugged or the digital component turned off. ➔ Connect the cable or turn the digital component back on.

Notes on CDs

On handling CDs

- To keep the disc clean, hold it along its edges only. Do not leave fingerprints on the surface.
- Do not stick adhesive papers or tapes onto the disc.



- Only regular circular discs can be used in this deck. Irregularly shaped discs, such as star- or heart-shaped discs, may damage the deck.
- If there is glue or a similar substance on the disc, remove it completely before using the disc.

On storage

- Do not expose the disc to direct sunlight, heat sources, or high humidity.
- Store discs in their cases. Do not store discs either stacked horizontally or standing vertically without their cases.

On cleaning

- Fingerprints or dust on the CD may cause poor sound reproduction or sound dropout.
- Before playing a disc, clean it with a cleaning cloth. Wipe the disc from the center out.
- If the disc is still dirty after being wiped with a cleaning cloth, wipe it again with a slightly moistened cloth. Then wipe off the residual moisture with a dry cloth.
- Do not use solvents such as benzene, thinner, commercially available cleaners or antistatic spray intended for vinyl LPs.



Note on High-Speed CD Synchro-Recording

Certain CD conditions may cause sound dropout or noise in the recording results, or even create unwanted tracks on the MD. If this happens, clean the CD as instructed on "On cleaning" above, and record material to the MD using normal-speed CD Synchro-Recording only.

Sony  line

<http://www.world.sony.com/>
