

Compact Disc Player

Operating Instructions



CDP-CE345
CDP-CE245

WARNING

To prevent fire or shock hazard, do not expose the unit to rain or moisture.

To avoid electrical shock, do not open the cabinet. Refer servicing to qualified personnel only.

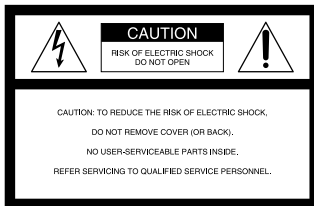

This symbol is intended to alert the user to the presence of uninsulated “dangerous voltage” within the product’s enclosure that may be of sufficient magnitude to constitute a risk of electric shock to persons.



This symbol is intended to alert the user to the presence of important operating and maintenance (servicing) instructions in the literature accompanying the appliance.

INFORMATION

This equipment has been tested and found to comply with the limits for a Class B digital device, pursuant to Part 15 of the FCC Rules. These limits are designed to provide reasonable protection against harmful interference in a residential installation. This equipment generates, uses, and can radiate radio frequency energy and, if not installed and used in accordance with the instructions, may cause harmful interference to radio communications. However, there is no guarantee that interference will not occur in a particular installation. If this equipment does cause harmful interference to radio or television reception, which can be determined by turning the equipment off and on, the user is encouraged to try to correct the interference by one or more of the following measures:

- Reorient or relocate the receiving antenna.
- Increase the separation between the equipment and receiver.
- Connect the equipment into an outlet on a circuit different from that to which the receiver is connected.
- Consult the dealer or an experienced radio/TV technician for help.

CAUTION

You are cautioned that any changes or modification not expressly approved in this manual could void your authority to operate this equipment.

Owner’s Record

The model and serial numbers are located at the rear of the unit. Record the serial number in the space provided below. Refer to them whenever you call upon your Sony dealer regarding this product.

Model No. _____

Serial No. _____

Welcome!

Thank you for purchasing the Sony Compact Disc Player. Before operating the unit, please read this manual thoroughly and retain it for future reference.

About This Manual

The instructions in this manual are for models CDP-CE345 and CDP-CE245. The CDP-CE345 is the model used for illustration purposes, unless otherwise mentioned. Any difference in operation is clearly indicated in the text, for example, “CDP-CE345 only.”

Conventions

- Instructions in this manual describe the controls on the player. You can also use the controls on the remote if they have the same or similar names as those on the player.
- The following icons are used in this manual:



Indicates that you can do the task using the remote. (Note that the CDP-CE245 cannot do the tasks marked with this icon.)



Indicates hints and tips for making the task easier.

TABLE OF CONTENTS

Getting Started

Unpacking	4
Hooking Up the System	4

Playing a CD	6
--------------------	---

Playing CDs

Using the Display	8
Replacing Discs While Playing a Disc	9
Locating a Specific Disc	9
Locating a Specific Track or a Particular Point in a Track	10
Playing Repeatedly	11
Playing in Random Order (Shuffle Play)	11
Creating Your Own Program (Program Play)	12

Recording From CDs

Recording Your Own Program	14
Recording a CD by Specifying Tape Length (Time Edit)	14
Fading In or Out	15
Adjusting the Recording Level (Peak Search)	16

Additional Information

Precautions	17
Notes on CDs	17
Troubleshooting	18
Specifications	18

Index

Index	19
-------------	----

Unpacking

Check that you received the following items:

- Audio connecting cord (1)
- Remote commander (remote) (1) (CDP-CE345 only)
- Size AA (R6) batteries (2) (CDP-CE345 only)

Inserting batteries into the remote (CDP-CE345 only)

You can control the player using the supplied remote. Insert two size AA (R6) batteries by matching the + and - on the batteries to the diagram inside the battery compartment.

Insert the negative (-) end first, then push in and down until the positive (+) end clicks into position.

When using the remote, point it at the remote sensor  on the player.

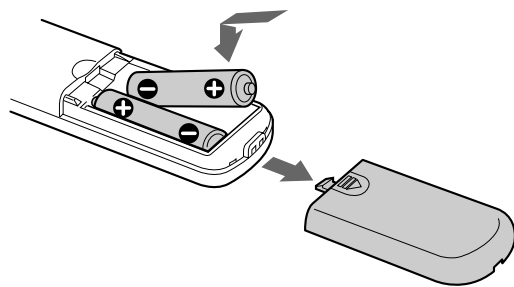

When to replace batteries

With normal use, the batteries should last for about six months. When the remote no longer operates the player, replace all the batteries with new ones.

Notes

- Do not leave the remote near an extremely hot or humid place.
- Do not drop any foreign object into the remote casing, particularly when replacing the batteries.
- Do not expose the remote sensor to direct sunlight or lighting apparatuses. Doing so may cause a malfunction.
- If you don't use the remote for an extended period of time, remove the batteries to avoid possible damage from battery leakage and corrosion.

Hooking Up the System

Overview

This section describes how to hook up the CD player to an amplifier. Be sure to turn off the power of each component before making the connections.

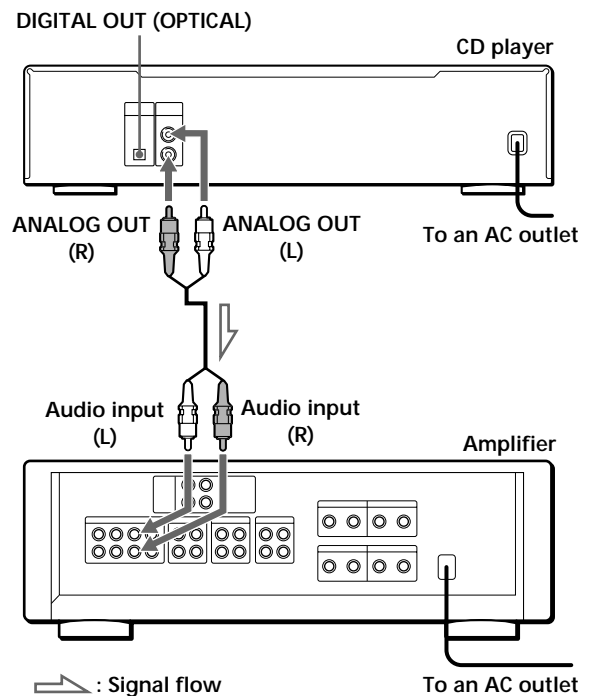

What cords will I need?

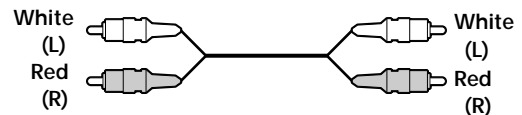

Audio cord (supplied) (1)

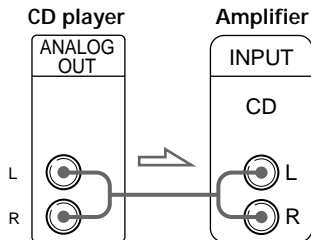

Hookups

When connecting an audio cord, be sure to match the color-coded cord to the appropriate jacks on the components: Red (right) to Red and White (left) to White. Be sure to make connections firmly to avoid hum and noise.



 You can adjust the output level to the amplifier (CDP-CE345 only) 

Press ANALOG OUT LEVEL +/- on the remote. You can reduce the output level up to -20 dB.

When you reduce the output level, "FADE" appears in the display.

When you turn off the player, the output level automatically returns to the maximum level.

Note

If you press the ANALOG OUT LEVEL +/- buttons on the remote while recording, the recording level will change even when it is preset on the tape deck, etc.

- If you have a digital component such as a digital amplifier, D/A converter, DAT or MD

Connect the component via the DIGITAL OUT (OPTICAL) connector using the optical cable (not supplied). Take off the cap and plug in the optical cable.

Note that you cannot use fading in or out (page 15) and Time Fade (page 15) functions when making this connection.

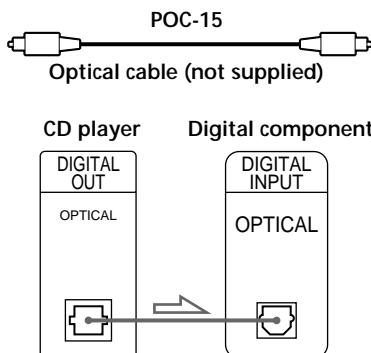

Note

When you connect via the DIGITAL OUT (OPTICAL) connector, noise may occur when you play CD software other than music, such as a CD-ROM.

Setting the voltage selector (voltage selector equipped models only)

Check that the voltage selector on the rear panel of the player is set to the local power line voltage. If not, set the selector to the correct position using a screwdriver before connecting the AC power cord to a wall outlet.

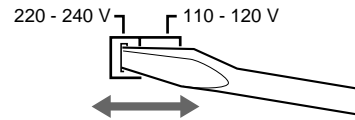

Connecting the AC power cord

Connect the AC power cord to a wall outlet.

Transporting the player

Before transporting the player, follow the procedure below to return the internal mechanisms back to their original position.

- 1 Remove all the discs from the disc tray.
- 2 Press  OPEN/CLOSE to close the disc tray. "no DISC" appears in the display.
- 3 Wait for 10 seconds, then press POWER to turn off the player.

Playing a CD

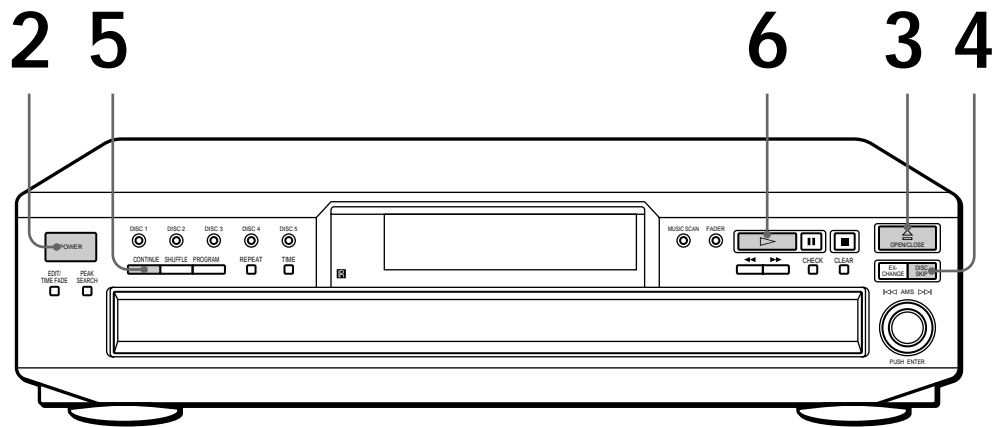

- See pages 4 - 5 for the hookup information.

- 1 Turn on the amplifier and select the CD player position so that you can listen to the sound from this player.
- 2 Press POWER to turn on the player.
- 3 Press OPEN/CLOSE, and place a disc on the disc tray.

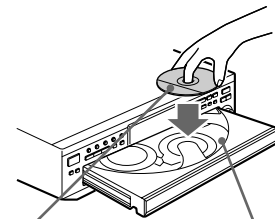



With the label side up

Disc number

- 4 To place other discs, press DISC SKIP and place the discs in the order you want to play.
Each time you press the button, the disc tray turns and you can place the discs in the empty disc compartments. The player plays the disc in front of you first.
- 5 Press CONTINUE to select ALL DISCS or 1 DISC Continuous Play mode.
Each time you press the CONTINUE button, "ALL DISCS" or "1 DISC" appears in the display.

When you select	The player plays
ALL DISCS	All discs in the player consecutively in the order of disc number
1 DISC	Only the disc you've selected

 You can select the disc you want to start playing first. Press one of the DISC 1 - 5 buttons.

 You can adjust the output level to the amplifier (CDP-CE345 only)  Press ANALOG OUT LEVEL +/- on the remote. You can reduce the output level up to -20 dB. When you reduce the output level, "FADE" appears in the display. When you turn off the player, the output level automatically returns to the maximum level.

Note





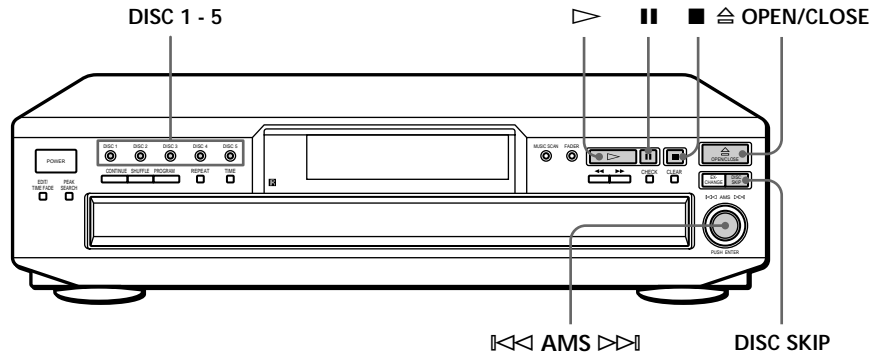

If you press the ANALOG OUT LEVEL +/- buttons on the remote while recording, the recording level will change even when it is preset on the tape deck, etc.

6 Press . The disc tray closes and the player plays all the tracks once (Continuous Play). Adjust the volume on the amplifier.

To stop playback

Press .



To	You need to
Pause	Press 
Resume play after pause	Press  or 
Go to the next track	Turn  clockwise
Go back to the preceding track	Turn  counterclockwise
Go to the next disc	Press DISC SKIP
Select a disc directly	Press DISC 1 - 5
Stop play and remove the CD	Press 

Using the Display

You can check information about the disc using the display.

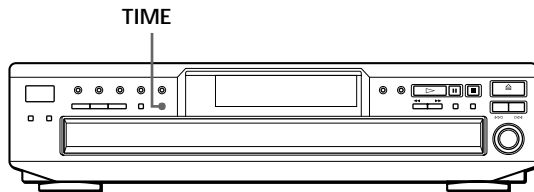

Display information while playing a disc

While playing a disc, the display shows the current disc number, track number, playing time of the track and the music calendar.

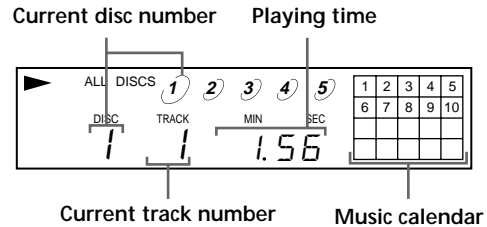

Checking the total number and playing time of the tracks

Press TIME before you start playing. The display shows the current disc number, the total number of tracks, total playing time and music calendar.

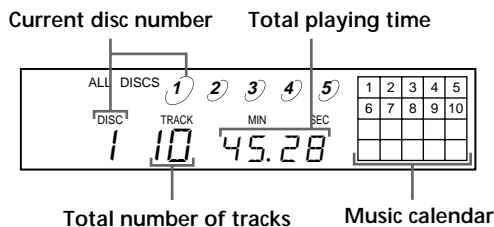

The information also appears when you press the OPEN/CLOSE button to close the disc tray. The tracks numbered over 20 cannot be displayed in the music calendar.

Notes on the disc number indications

- The red circle around a disc number indicates the disc is ready to be played.
- When all the tracks on a disc have been played, the semi-circle around the disc number disappears.
- When a disc compartment is recognized as empty, the semi-circled disc number disappears.

The track numbers in the music calendar disappear after they are played.

Checking the remaining time

Each time you press the TIME button while playing a disc, the display changes as shown in the chart below.

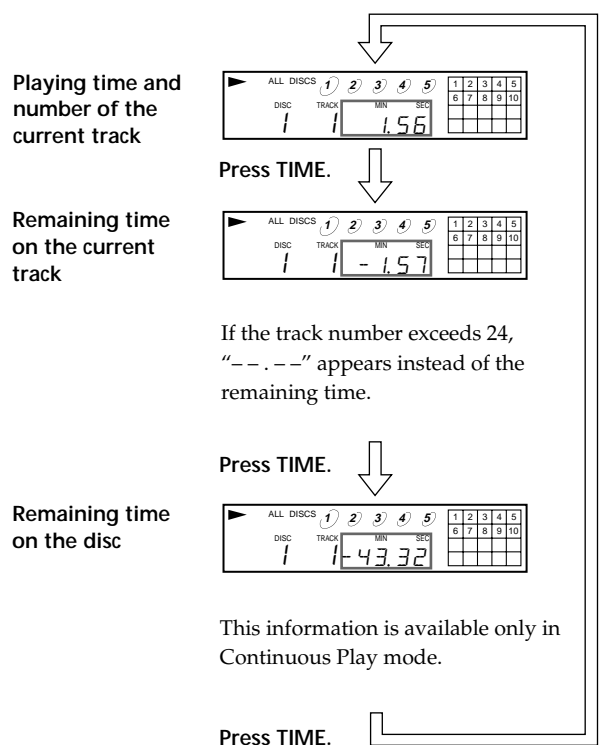

Replacing Discs While Playing a Disc

You can open the disc tray while playing a disc so that you can check what discs are to be played next and replace discs without interrupting playback of the current disc.

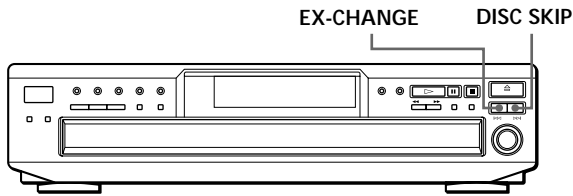

- 1 Press EX-CHANGE.
The disc tray opens and two disc compartments appear. Even if the player is playing a disc, it doesn't stop playing.
- 2 Replace discs in the compartments with new ones.
The player plays the disc on the left side compartment after the current disc, and then the one on the right side compartment.
- 3 Press DISC SKIP.
The disc tray turns and other two disc compartments appear.
- 4 Replace discs in the compartments with new ones.
- 5 Press EX-CHANGE.
The disc tray closes.

While the disc tray is open by pressing the EX-CHANGE button

- If the playback of the current disc ends, the player stops playing. If the disc is played in 1 DISC Repeat Play mode (see page 11), the current disc starts playing again.
- In ALL DISCS Shuffle Play mode (see page 11), tracks are reshuffled on the current disc.
- In Program Play mode (see page 12), only the tracks on the current disc are played.
- Do not push the disc tray to close it in Step 5, as you may damage the player.

Locating a Specific Disc

You can locate any disc before or while playing a disc.

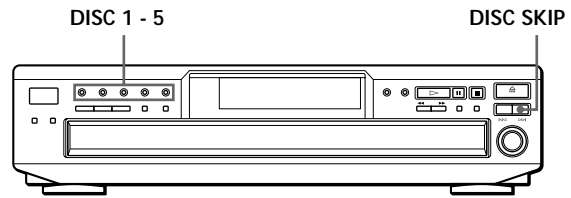

To locate	Press
The next disc	DISC SKIP while playing a disc
A specific disc directly	DISC 1 - 5

Locating a Specific Track or a Particular Point in a Track

You can quickly locate any track while playing a disc using the AMS (Automatic Music Sensor) control. You can also locate a specific point in a track while playing a disc.

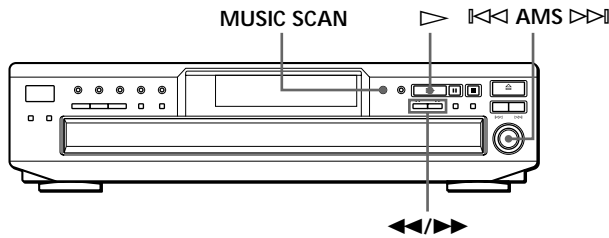

(CDP-CE345 only)

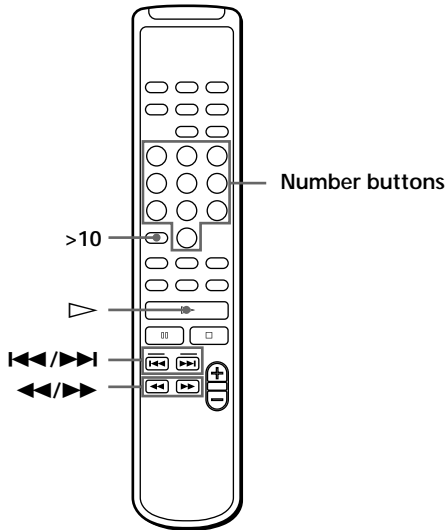

To locate	You need to
The next or succeeding tracks	Turn AMS clockwise until you find the track. When using the remote, press ▶▶ repeatedly until you find the track.
The current or preceding tracks	Turn AMS counterclockwise until you find the track. When using the remote, press ◀◀ repeatedly until you find the track.
A specific track directly (CDP-CE345 only)	Press the number button of the track on the remote
A track by scanning each track for 10 seconds (Music Scan)	Press MUSIC SCAN before you start playing. When you find the track you want, press ▶ to start playing.
A point while monitoring the sound	Press ▶▶ (forward) or ◀◀ (backward) and hold down until you find the point.
A point quickly by observing the display during pause	Press ▶▶ (forward) or ◀◀ (backward) and hold down until you find the point. You will not hear the sound during the operation.

💡 When you directly locate a track numbered over 10 (CDP-CE345 only)

Press **>10** first, then the corresponding number buttons on the remote. To enter "0," use button 10/0.

Example: To play track number 30
Press **>10** first, then 3 and 10/0.

💡 You can extend the playing time during Music Scan
Press **MUSIC SCAN** repeatedly until the playing time you want (10, 20 or 30) appears in the display. Each time you press the button, the playing time changes cyclically.

Note

If "⌂" appears in the display, the disc has reached the end while you were pressing the **▶▶** button. Press **◀◀** or turn **AMS** counterclockwise to go back.

Playing Repeatedly

You can play discs/tracks repeatedly in any play mode.

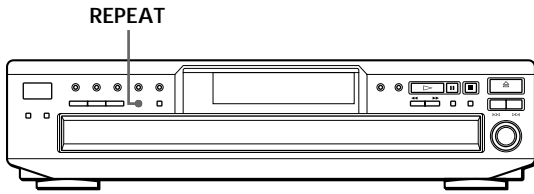

Press REPEAT while playing a disc. "REPEAT" appears in the display. The player repeats the discs/tracks as follows:

When the disc is played in	The player repeats
Continuous Play (ALL DISCS) (page 6)	All the tracks on all discs
Continuous Play (1 DISC) (page 6)	All the tracks on the current disc
Shuffle Play (ALL DISCS) (page 11)	All the tracks on all discs in random orders
Shuffle Play (1 DISC) (page 12)	All the tracks on the current disc in random orders
Program Play (page 12)	The same program

To cancel Repeat Play

Press REPEAT repeatedly until "REPEAT" disappears from the display.

Repeating the current track

You can repeat only the current track while the disc is played in any play mode.

While the track you want is being played, press REPEAT repeatedly until "REPEAT 1" appears in the display.

Playing in Random Order (Shuffle Play)

You can have the player "shuffle" tracks and play in a random order. The player shuffles all the tracks on all discs or on the disc you've specified.

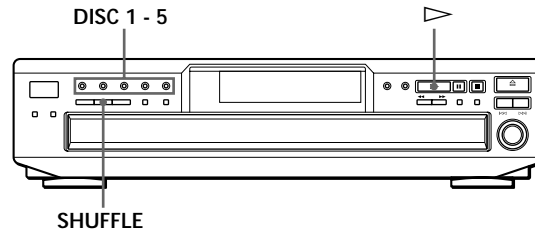

Shuffle Play on all discs

You can play all tracks on all discs in a random order.

- 1 Press SHUFFLE repeatedly until "ALL DISCS" appears in the display.
- 2 Press ▷ to start ALL DISCS Shuffle Play. The [] indication appears while the player is "shuffling" the tracks.

To cancel Shuffle Play

Press CONTINUE.

💡 You can start Shuffle Play while playing

Press SHUFFLE, and Shuffle Play starts from the current track.

💡 You can specify discs during Shuffle Play (Select Shuffle Play)

You can specify discs during ALL DISCS Shuffle Play mode, and the tracks on the specified discs are played in a random order.

Press DISC 1 - 5 to specify the discs after Step 1. Semi-circles appear around the specified disc numbers in the display. To cancel the selected discs, press DISC 1 - 5 again. The semi-circles disappear.

To return to ALL DISCS Shuffle Play, press SHUFFLE twice.

Shuffle Play on one disc

You can play all tracks on the specific disc in a random order.

- 1 Press SHUFFLE repeatedly until "1 DISC" appears in the display.
- 2 Press DISC 1 - 5 to start 1 DISC Shuffle Play on the selected disc.
The [] indication appears while the player is "shuffling" the tracks.

To cancel Shuffle Play
Press CONTINUE.

- 💡 You can start Shuffle Play while playing
Press SHUFFLE, and Shuffle Play starts from the current track.

Creating Your Own Program (Program Play)

You can arrange the order of the tracks on the discs and create your own program. The program can contain up to 32 "steps" — one "step" may contain a track or a whole disc.

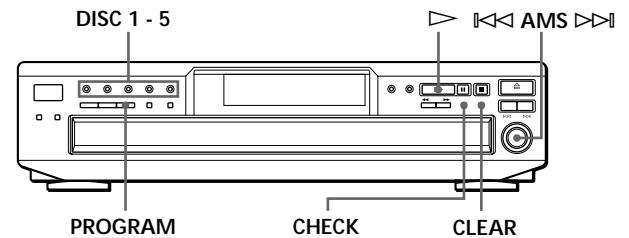

- 1 Press PROGRAM.
"PROGRAM" appears in the display.
If a program is already stored, the last step of the program appears in the display. When you want to erase the whole program, hold down CLEAR until "ALL CLR" appears in the display (see page 13).
- 2 Press DISC 1 - 5 to select the disc.

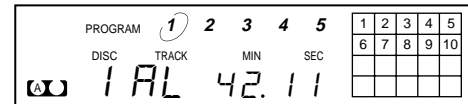

"AL" in the display stands for "all" tracks.
When you want to program the whole disc as one step, skip Steps 3 to 4, and go to Step 5.

- 3 Turn [] until the track number you want appears in the display.
The track number being programmed flashes and the total playing time including the track appears in the display.

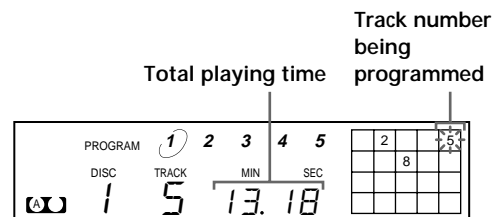

4 Push **◀◀ AMS ▶▶** to select the track.

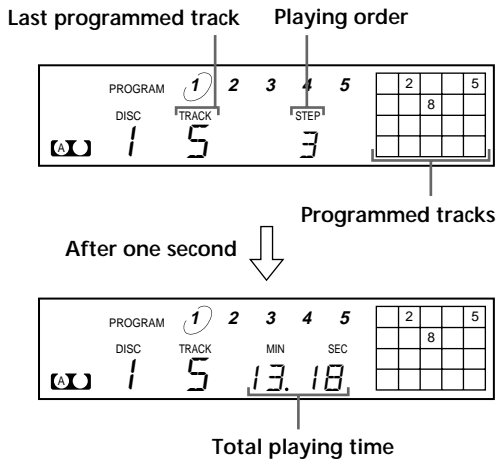

If you've made a mistake
Press CLEAR, then repeat Steps 3 and 4.

5 To program other discs or tracks, do the following:

To program	Repeat Step(s)
Other discs	2
Other tracks on the same disc	3 and 4
Other tracks on other discs	2 through 4

6 Press **▷** to start Program Play.

To cancel Program Play

Press CONTINUE. The program remains in memory even if you stop the Program Play.

You can create your program while checking the disc labels

While the disc tray is open, follow Steps 1 to 6 with pressing the DISC SKIP button to check the disc labels. If you close the disc tray before Step 6, the total playing time appears in the display after a while.

Note that, if the programmed track number isn't found on the disc, that step is automatically erased.

The program remains even after the Program Play ends

When you press the **▷** button, you can play the same program again.

The program remains until you erase it or turn off the player

If you replace discs, the programmed disc and track numbers remain. So, the player plays only the existing disc and track numbers. However, the disc and track numbers that aren't found in the player or on the disc are deleted from the program, and the rest of the program is played in the programmed order.

Note

- The total playing time doesn't appear when:
 - You have programmed a track whose number exceeds 20.
 - The total playing time of the program exceeds 200 minutes.

Checking the track order

You can check your program before or after you start playing.

Press CHECK.

Each time you press this button, the display shows the track (the disc and track numbers) or the disc (the disc number and "AL" indication) of each step in the programmed order. After the last step in the program, the display shows "End" and returns to the original display. If you check the order after you start playing, the display shows only the remaining steps.

Changing the track order

You can change your program before you start playing.

To	You need to
Erase a track	Press CHECK until the track you don't want appears in the display, then press CLEAR.
Erase the last track in the program	Press CLEAR. Each time you press the button, the last track will be cleared.
Add tracks to the end of the program	Follow Steps 2 through 4 of the programming procedure.
Change the whole program completely	Hold down CLEAR until "ALL CLR" appears in the display. Create a new program following the programming procedure.

Recording Your Own Program

You can record the program you've created on a tape, etc. The program can contain up to 32 steps. By inserting a pause during programming, you can divide the program into two for recording on both sides of a tape.

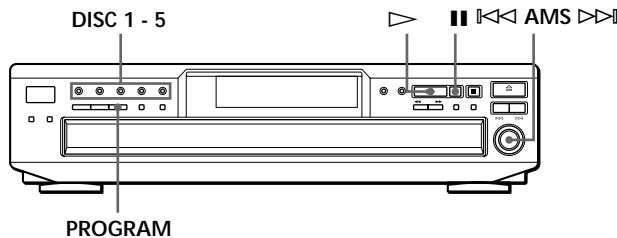

- 1 Create your program (for side A when recording on a tape) while checking the total playing time indicated in the display. Follow Steps 1 to 5 in "Creating Your Own Program" on page 12. The indication appears in the display.
- 2 When you record on both sides of the tape, press to insert a pause. The "P" and indications appear in the display and the playing time is reset to "0.00." When you record on one side of the tape, skip this step and go to Step 4.

A pause is counted as one step
You can program up to 31 steps when you insert a pause.
- 3 Repeat Steps 2 to 5 in "Creating Your Own Program" on page 12 to create the program for side B.
- 4 Start recording on the deck and then press on the player. When you record on both sides of the tape, the player pauses at the end of the program for side A.
- 5 When you record on side B, reverse the tape and press or on the player to resume playing.

To check and change your program
See page 13.
The indication appears while checking the program for side A and while checking the program for side B.

Recording a CD by Specifying Tape Length (Time Edit)

You can have the player create a program that will fit the length of the tape. The player automatically creates a program, keeping the original order of the disc. The program can contain up to 32 steps (a pause inserted between steps is counted as one step). Note that tracks numbered over 20 cannot be programmed automatically.

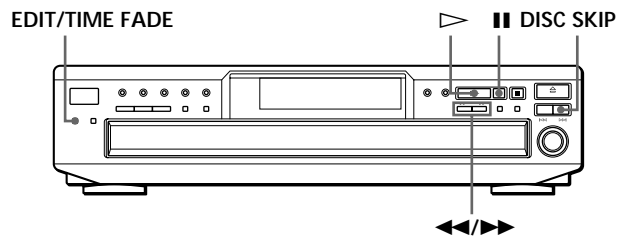

- 1 Press DISC SKIP to select the disc.
- 2 Press EDIT/TIME FADE repeatedly before you start playing until "EDIT" appears and "A" in the indication flashes in the display.
- 3 Press or to specify the tape length. Each time you press these buttons, the display changes as shown below, with the tape length of one side following each indication.

→ C-46 ↔ C-54 ↔ C-60 ↔ C-74 ↔ C-90 → - - - - -

(23.00) (27.00) (30.00) (37.00) (45.00)
- 4 Press EDIT/TIME FADE to have the player create the program. The display shows the tracks to be recorded. "B" in the indication flashes in the display.
- 5 When you record on both sides of the tape, press EDIT/TIME FADE again. The player inserts a pause, then creates the program for side B. The display shows the programmed tracks. When you record on one side of the tape, skip this step.
- 6 Start recording on the deck and then press on the player. When you record on both sides of the tape, the player pauses at the end of the program for side A.

- 7 Reverse the tape to side B and press ▷ or || on the player to resume playing the remaining tracks.

To cancel Time Edit
Press CONTINUE.

You can program the tracks you want in advance
Create a program selecting the desired tracks, then follow Steps 2 to 7. Be careful that the total playing time of the program does not exceed the tape length of one side.

You can freely specify the tape length
Set the tape length using the ◀◀ AMS ▶▶ control.
Example: When the tape length of one side is 30 minutes and 15 seconds

- 1 To set the minutes, turn ◀◀ AMS ▶▶ until "30" appears in the display, then push ◀◀ AMS ▶▶.
- 2 To set the seconds, turn ◀◀ AMS ▶▶ until "15" appears in the display, then push ◀◀ AMS ▶▶.

You can check and change the program
See page 13.

Fading In or Out

You can manually fade in or out to prevent tracks from starting or ending abruptly.
Note that you cannot use this effect when you use the DIGITAL OUT (OPTICAL) connector.

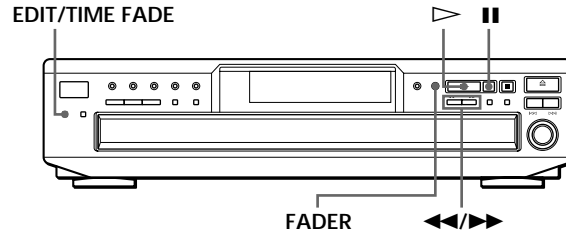

To	Press FADER
Start play fading in	During pause. "FADE" flashes, then the play fades in.
End play fading out	When you want to start fading out. "FADE" flashes and the play fades out. Then the player pauses.

Note
Fading lasts for about 5 seconds. However, when you press the FADER button during Music Scan (see page 10), the play fades out for about 2 seconds.

Fading out at the specified time (Time Fade)

You can have the player fade out automatically by specifying the playing time. Once you set the Time Fade, it works twice, that is, the play fades out at the end of both sides of a tape.

- 1 Press EDIT/TIME FADE repeatedly before you start playing until $\langle \text{TIME FADE} \rangle$ and $\langle \text{XX} \rangle$ appear in the display.
- 2 Press ◀◀ or ▶▶ to specify the playing time. Each time you press these buttons, the display changes as shown below, with the playing time of one side following each indication.

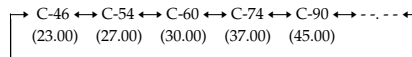



(Continued)

- 3 Press \triangleright to start playing.
At the specified time the play fades out and the player pauses. **UF** appears in the display.
- 4 Reverse the tape to side B and press \triangleright or **II** on the player to resume playing the remaining tracks. Again, the play fades out at the specified time.

To cancel Time Fade

Press EDIT/TIME FADE.

 You can freely specify the playing time
See "You can freely specify the tape length" on page 15.

 You can change discs during Time Fade
If the play ends before the specified fade-out time, (for example, when you record CD-singles on a tape) change the disc. The specified fade-out time is counted only during playing.

 You can fade in to resume playing in Step 4
After you reverse the tape, press FADER.

Note

If you press the \blacktriangleleft or \blacktriangleright button during Time Fade Play, Time Fade will be cancelled.

Adjusting the Recording Level (Peak Search)

The player locates the highest level among the tracks to be recorded to let you adjust the recording level before you start recording.

PEAK SEARCH

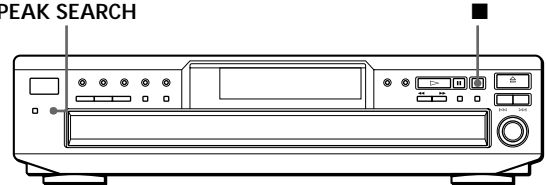

- 1 Before you start playing, press PEAK SEARCH. "PEAK" flashes in the display and the player starts scanning the disc searching for the highest peak level.
After scanning all the tracks, the player repeats the portion with the highest peak level.
- 2 Adjust the recording level on the deck.
- 3 Press \blacksquare on the player to stop Peak Search. "PEAK" disappears from the display.

Notes

- The portion with the highest level may differ every time you try the adjustment on the same disc. The difference is, however, so slight that you won't find any problem in adjusting the recording level precisely.
- Peak Search does not operate while you open the disc tray by pressing the EX-CHANGE button.

Precautions

On safety

- Caution — The use of optical instruments with this product will increase eye hazard.
- Should any solid object or liquid fall into the cabinet, unplug the player and have it checked by qualified personnel before operating it any further.

On power sources

- Before operating the player, check that the operating voltage of the player is identical with your local power supply. The operating voltage is indicated on the nameplate at the rear of the player.
- The player is not disconnected from the AC power source (mains) as long as it is connected to the wall outlet, even if the player itself has been turned off.
- If you are not going to use the player for a long time, be sure to disconnect the player from the wall outlet. To disconnect the AC power cord (mains lead), grasp the plug itself; never pull the cord.
- AC power cord must be changed only at the qualified service shop.

On placement

- Place the player in a location with adequate ventilation to prevent heat build-up in the player.
- Do not place the player on a soft surface such as a rug that might block the ventilation holes on the bottom.
- Do not place the player in a location near heat sources, or in a place subject to direct sunlight, excessive dust or mechanical shock.

On operation

- If the player is brought directly from a cold to a warm location, or is placed in a very damp room, moisture may condense on the lenses inside the player. Should this occur, the player may not operate properly. In this case, remove the disc and leave the player turned on for about an hour until the moisture evaporates.

On adjusting volume

- Do not turn up the volume while listening to a portion with very low level inputs or no audio signals. If you do, the speakers may be damaged when a peak level portion is played.

On cleaning

- Clean the cabinet, panel and controls with a soft cloth slightly moistened with a mild detergent solution. Do not use any type of abrasive pad, scouring powder or solvent such as alcohol or benzine.

If you have any questions or problems concerning your player, please consult your nearest Sony dealer.

Notes on CDs

On handling CDs

- To keep the disc clean, handle the disc by its edge. Do not touch the surface.
- Do not stick paper or tape on the disc.

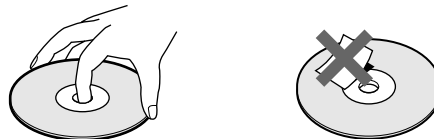

- Do not expose the disc to direct sunlight or heat sources such as hot air ducts, nor leave it in a car parked in direct sunlight as there can be considerable rise in temperature inside the car.
- Do not use any commercially available stabilizer. If you do, the disc and the player may be damaged.
- After playing, store the disc in its case.

On cleaning

- Before playing, clean the disc with a cleaning cloth. Wipe the disc from the center out.

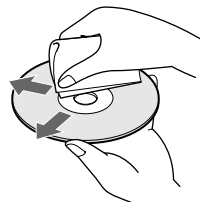

- Do not use solvents such as benzene, thinner, commercially available cleaners or anti-static spray intended for vinyl LPs.

Troubleshooting

If you experience any of the following difficulties while using the player, use this troubleshooting guide to help you remedy the problem. Should any problem persist, consult your nearest Sony dealer.

There's no sound.

- ➔ Check that the player is connected securely.
- ➔ Make sure you operate the amplifier correctly.
- ➔ Adjust the playback level using the ANALOG OUT LEVEL +/- buttons on the remote (CDP-CE345 only).

The CD does not play.

- ➔ There's no CD inside the player ("no dISC" appears). Insert a CD.
- ➔ Place the CD with the label side up on the disc tray correctly.
- ➔ Clean the CD (see page 17).
- ➔ Moisture has condensed inside the player. Remove the disc and leave the player turned on for about an hour (see page 17).
- ➔ Place the CD in the correct position on the disc tray.

The remote does not function. (CDP-CE345 only)

- ➔ Remove the obstacles in the path of the remote and the player.
- ➔ Point the remote at the remote sensor  on the player.
- ➔ Replace all the batteries in the remote with new ones if they are weak.

The player functions incorrectly.

- ➔ The microcomputer chips may be operating incorrectly. Turn the power off, then turn it back on to reset the player.

Specifications

Compact disc player

Laser	Semiconductor laser ($\lambda = 780 \text{ nm}$) Emission duration: continuous
Laser output	Max 44.6 μW * * This output is the value measured at a distance of 200 mm from the objective lens surface on the Optical Pick-up block with 7 mm aperture.
Frequency response	2 Hz to 20 kHz $\pm 0.5 \text{ dB}$
Dynamic range	More than 93 dB
Harmonic distortion	Less than 0.0045 %

Output

	Jack type	Maximum output level	Load impedance
ANALOG OUT	Phono jacks	2 V (at 50 kilohms)	Over 10 kilohms
DIGITAL OUT (OPTICAL)	Optical output connector	-18 dBm	Wave length: 660 nm

General

Power requirements	120 V AC, 60 Hz
Power consumption	11 W
Dimensions (approx.) (w/h/d)	430 \times 110 \times 398 mm (17 \times 4 3/8 \times 15 3/4 in.) incl. projecting parts
Mass (approx.)	5 kg (11 lbs 1 oz.)

Supplied accessories

See page 4.

Design and specifications are subject to change without notice.

Index

A, B

- AMS 10
- Automatic Music Sensor. *See* AMS

C, D

- Connecting 4
- Continuous Play 6

E

- Editing. *See* Recording

F, G

- Fading 15
- Time Fade 15

H, I, J, K

- Handling CDs 17
- Hookups 4
- overview 4

L

- Locating
 - by monitoring 10
 - by observing the display 10
 - by scanning 10
 - using AMS 10

M, N, O

- Music Scan 10

P, Q

- Peak search 16
- Playback
 - Continuous Play 6
 - Program Play 12
 - Repeat Play 11
 - Shuffle Play 11
- Program 12
 - changing 13
 - checking 13
 - for recording 14

R

- Recording 14
 - a program 14
 - using Time Edit 14
- Remaining time 8
- Remote control 4
- Repeating 11
- Replacing discs while playing a disc 9

S

- Scanning. *See* Music Scan
- Searching. *See* Locating
- Select Shuffle Play 11
- Shuffle Play 11

T

- Time Edit 14
- Time Fade 15
- Total playing time 8
- Troubleshooting 18

U

- Unpacking 4

V, W, X, Y, Z

- Voltage Selector 5

Names of controls

Buttons

- ANALOG OUT LEVEL +/- 5
- CHECK 13
- CLEAR 13
- CONTINUE 6
- DISC 1 - 5 9
- DISC SKIP 7
- EDIT/TIME FADE 14, 15
- EX-CHANGE 9
- FADER 15
- MUSIC SCAN 10
- ⊞ OPEN/CLOSE 6
- PEAK SEARCH 16
- PROGRAM 12
- REPEAT 11
- SHUFFLE 11
- TIME 8
- ▷ 7
- ⏏ 7
- 7
- ◀◀/▶▶ 10
- ◀◀/▶▶ 10

Switch

- POWER 6

Control

- ⏪ AMS ⏩ 7

Jacks

- ANALOG OUT 4
- DIGITAL OUT 4

Others

- Disc tray 6
- Display 8
- Ⓜ 4

