

Trinitron[®] Color TV

Operating Instructions

- Before operating the unit, please read this manual thoroughly and retain it for future reference.

KV-XA21

WARNING

- Dangerously high voltages are present inside the TV.
- Operate the TV only between 110 – 240 V AC.

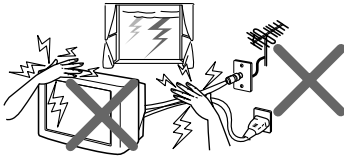

For your own safety, do not touch any part of the TV, the power cord and the antenna cable during lightning storms.



For children's safety, do not leave children alone with the TV. Do not allow children to climb onto it.

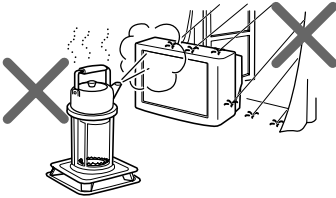

To prevent fire or shock hazard, do not expose the TV to rain or moisture.

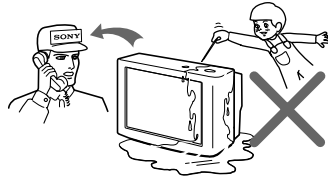

Do not operate the TV if any liquid or solid object falls into it. Have it checked immediately by qualified personnel only.

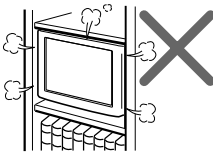

Do not block the ventilation openings of the TV. Do not install the TV in a confined space, such as a bookcase or built-in cabinet.

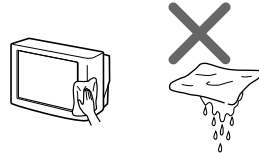

Clean the TV with a dry and soft cloth. Do not use benzine, thinner, or any other chemicals to clean the TV. Do not scratch the picture tube.

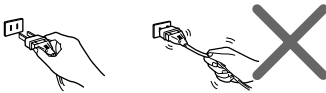

Pull the power cord out by the plug. Do not pull the power cord itself. Disconnect the TV before moving it or if you are not going to use it for several days.

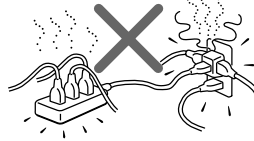

Do not plug in too many appliances to the same power socket. Do not damage the power cord.

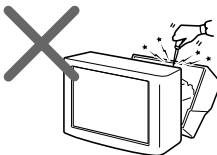

Do not open the cabinet and the rear cover of the TV as high voltages and other hazards are present inside the TV. Refer servicing and disposal of the TV to qualified personnel.

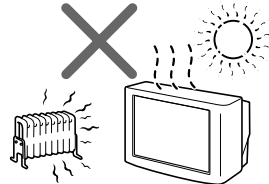

Your TV is recommended for home use only. Do not use the TV in any vehicle or where it may be subject to excessive dust, heat, moisture or vibrations.

Table of Contents

Using Your New TV

Getting Started	4
Step 1: Connect the antenna	4
Step 2: Insert the batteries into the remote	5
Step 3: Preset the channels automatically	5
Connecting the 3D WOOFER	6
Connecting optional components	7
Securing the TV	8
Presetting channels	9
Watching the TV	12

Advanced Operations

Customizing the picture and sound	15
Viewing your favorite channels	17
Blocking the channels (CHILD LOCK)	18
Enjoying Stereo or bilingual programs (KV-XA21M93 only)	19

Additional Information

Self-diagnosis function	21
Troubleshooting	22
Overview of controls	25
Specifications	Back cover

WARNING (continued)

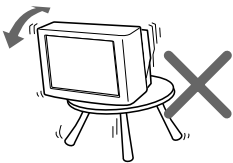

Do not install the TV in an unstable position.
Use a proper TV stand.

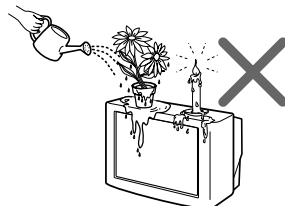

Do not place any objects on the TV.

Getting Started

Step 1

Connect the antenna

If you wish to connect a VCR, see the **Connecting a VCR** diagram below.

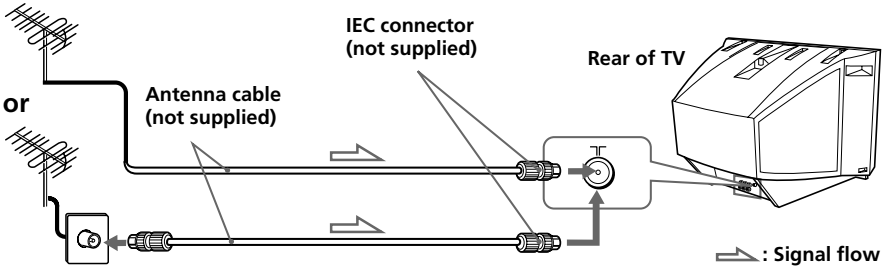

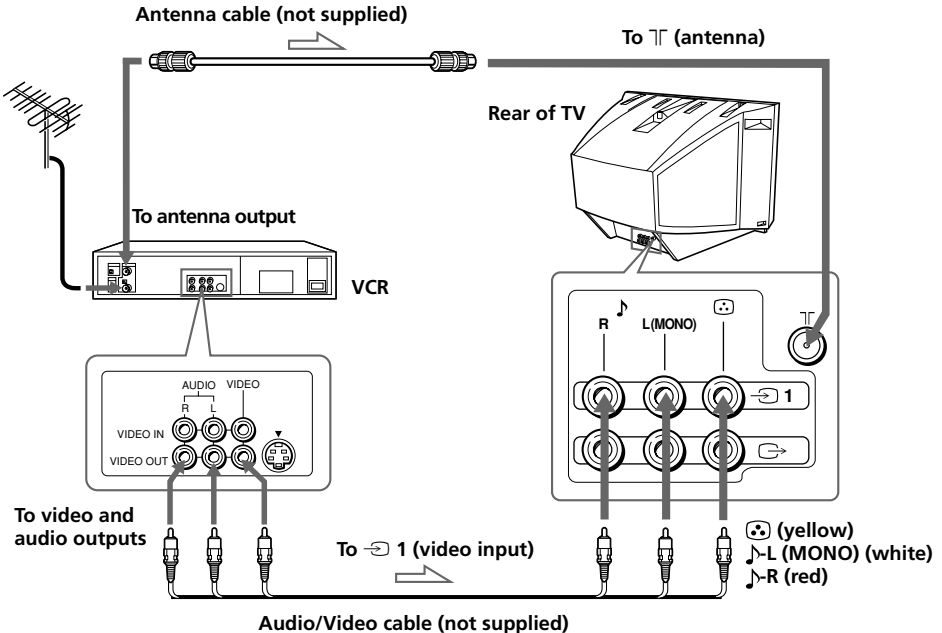

Connecting a VCR

To watch the video input, press (see page 13).



: Signal flow

Notes

- If you connect a monaural VCR, connect the yellow plug to  (the yellow jack) and the black plug to  (MONO) (the white jack).
- If you connect a VCR to the  (antenna) terminal, preset the signal output from the VCR to the program number 0 on the TV.
- When no signal is input from the connected video equipment, the TV screen becomes blue.

CAUTION

- Do not connect the power cord until you have completed making all other connections; otherwise a minimum leakage current might flow through the antenna and other terminals to ground.
- To avoid battery leakage and damage to the remote, remove the batteries from the remote if you are not going to use it for several days. If any liquid that leaks from the batteries touches you, immediately wash it away with water.

Step 2

Insert the batteries into the remote

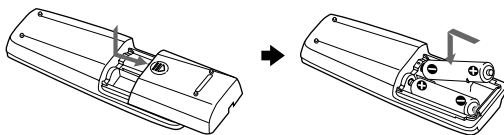
**Note**

- Do not use old batteries nor use different types of batteries together.

Step 3

Preset the channels automatically

Front of TV

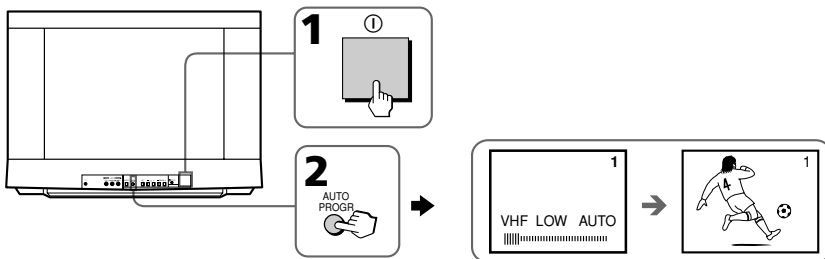
**Tips**

- If you want to stop automatic channel presetting, press SELECT twice.
- If your TV has preset an unwanted channel or cannot preset a particular channel, then preset your TV manually (see page 10).

Note (KV-XA21M83 only)

- During automatic channel presetting, your TV screen will indicate "B/G", "I", "D/K" or "M" for the TV system.

Connecting the 3D WOOFER

You can enjoy high quality sound by connecting the 3D WOOFER.

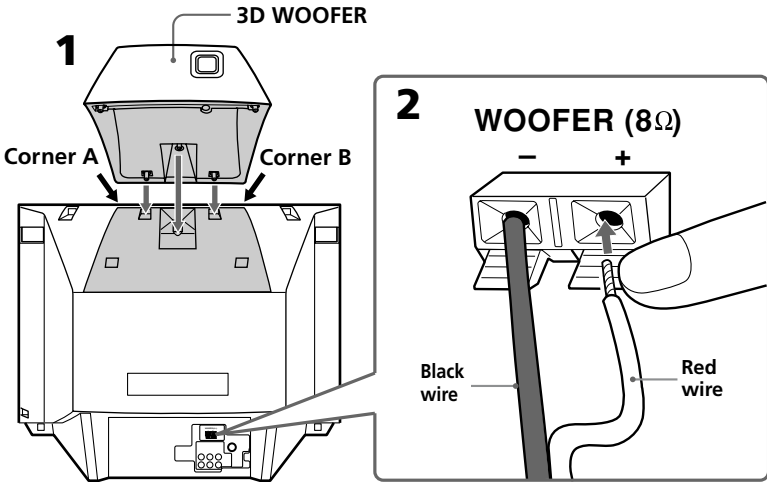

-
- 1** Align the front of the 3D WOOFER to corners A and B of your TV. Place the 3D WOOFER into the footholds and adjust it until it is stable.
 - 2** Connect the wires to the 3D WOOFER (8Ω) terminals at the rear of your TV. The red wire should be connected to the ⊕ red terminal and the black wire to the ⊖ black terminal.
-

Notes

- Connect only the supplied 3D WOOFER; otherwise your TV may malfunction.
- Unplug your TV from the wall outlet when connecting the 3D WOOFER.
- To prevent a malfunction caused by a short circuit of the terminals, make sure that none of the 3D WOOFER wire strands stick out, making contact with the neighbouring 3D WOOFER terminal.

Connecting optional components

You can connect optional audio/video components, such as a VCR, multi disc player, camcorder, video game or stereo system.

To watch the video input of the connected equipment, press \rightarrow (see page 13).

Connecting a camcorder/video game equipment using the \rightarrow 2 (video input) jacks

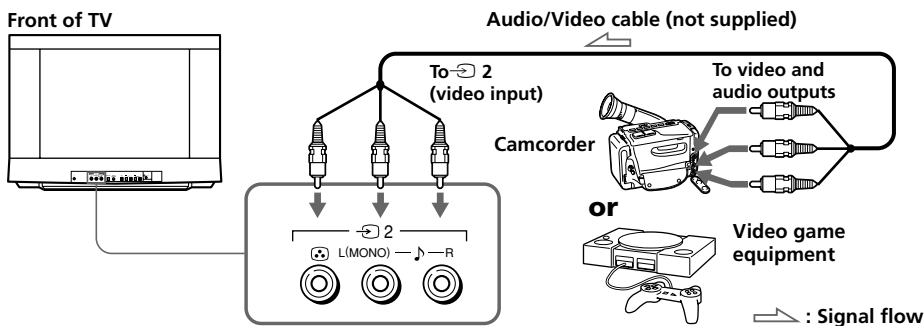

Note

- You can also connect video equipment to the \rightarrow 1 (video input) jack at the rear of your TV.

Connecting audio/video equipment using the \rightarrow 1 (monitor output) jacks

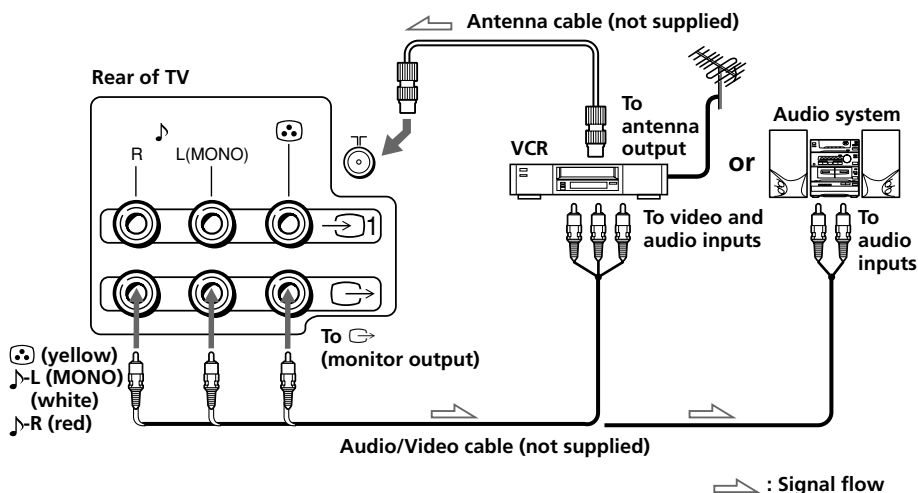

Note

- If you connect a monaural VCR, connect the yellow plug to ☺ (the yellow jack) and the black plug to ♪-L (MONO) (the white jack).

Securing the TV

To prevent the TV from falling, secure the TV using one of the following methods:

A With the supplied screws, attach the band to the TV stand and to the rear of the TV using the provided hole.

or

B Put the cord or chain through the clamps to secure the TV against a wall or pillar.

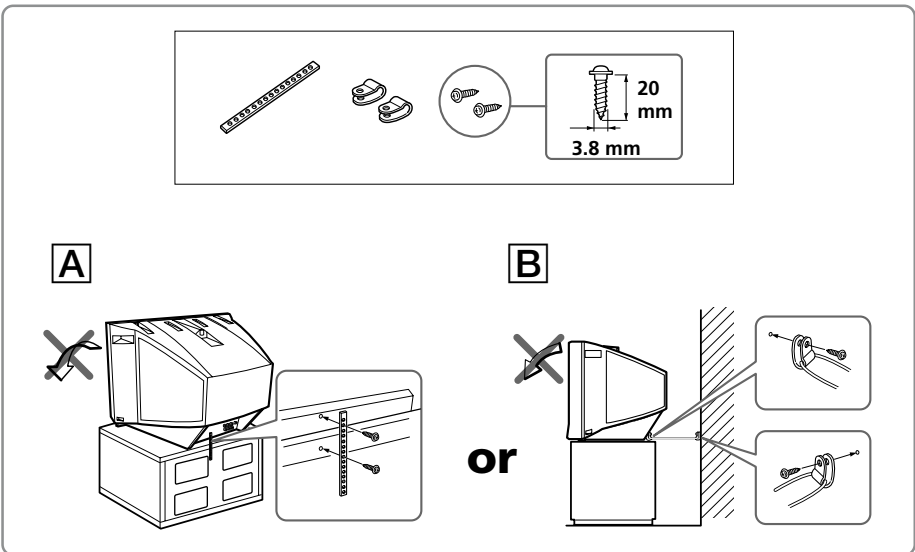

Note

- Use only the supplied screws. Use of other screws may damage the TV.

Presetting channels

You can preset up to 100 TV channels in numerical sequence from program number 1 using the remote and the buttons on your TV as well.

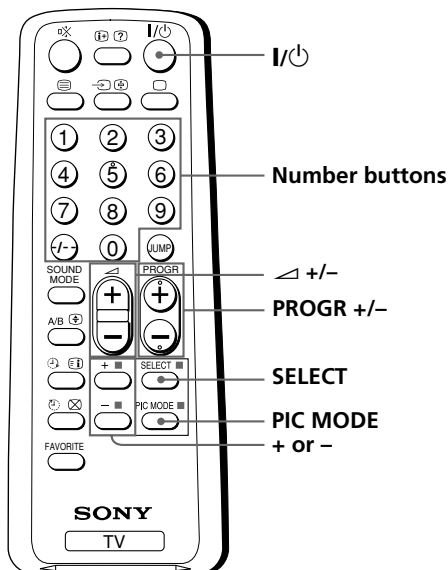
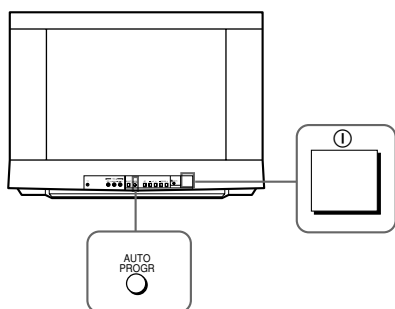

Presetting channels automatically

- 1** Press ① to turn on the TV.



- 2** Press AUTO PROGR.



VHF LOW AUTO
|||||

Note (KV-XA21M83 only)

- During automatic channel presetting, your TV screen will indicate "B/G", "I", "D/K" or "M" for the TV system.

To preset channels automatically from a specified program number

- (1) Press SELECT until "AUTO PROGRAM" appears.
- (2) Press + or -.
The on-screen display will start flashing.
- (3) Press PROGR +/- or the number buttons until the desired program number appears.
- (4) Press + or -.

continued

Presetting channels (continued)

Presetting channels manually

- 1 Press SELECT until "MANUAL PROGRAM" appears.



SELECT ■

MANUAL PROGRAM
- 2 Press + or –.



+ ■

– ■

VHF LOW B/G
- 3 Press PROGR +/- or the number buttons until the desired program number appears.

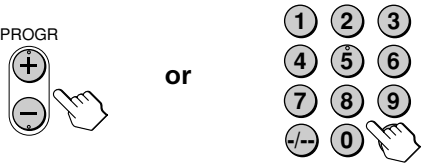

PROGR

or

1 2 3

4 5 6

7 8 9

/- 0
- 4 Press + or – until the desired channel picture appears.

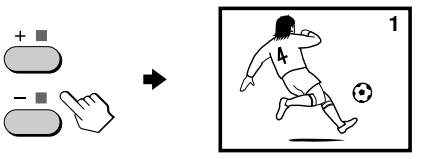

+ ■

– ■

1
- 5 Press SELECT.



SELECT ■

Note

- If you preset a locked program number, that particular program number will be unlock automatically (see page 18).

To change the TV system setting

If the picture or sound is abnormal when receiving programs through the ㄗ (antenna) terminal

- (1) Press SELECT until "TV SYS" appears.



TV SYS: B/G

- (2) Press + or – to select the appropriate TV system until the picture or sound quality is optimal.

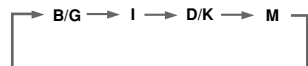

To change the color system setting

If the color is abnormal when receiving programs through the ㄗ (antenna) terminal or the ㊄ (video input) jack.

- (1) Press SELECT until "COLOR SYS" appears.

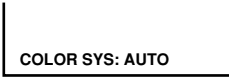

COLOR SYS: AUTO

- (2) Press + or - to select the appropriate color system until the color is optimal.

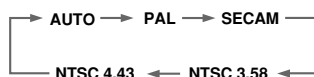

Tip

- Normally set "COLOR SYS" to "AUTO".

Skipping program numbers

- 1** Press PROGR +/- or the number buttons until the unused or unwanted program number appears.
- 2** Press SELECT until "MANUAL PROGRAM" appears.
- 3** Press + or -.
- 4** Press PIC MODE.
- 5** Press SELECT.

To restore the skipped program number again

Preset the channel automatically or manually.

Tip

- You can also use SELECT and ㄧ +/- on the TV to preset channels and skip program numbers.

To use the fine tuning (FINE) function

The fine tuning (FINE) function may help to reduce the following problems: double images and lines moving across the TV screen.

You can use the fine tuning function as below:

- (1) Select the program number you want to adjust.
- (2) Press SELECT until "MANUAL PROGRAM" appears on the screen.
- (3) Press + or - on the remote control once.
- (4) Press ㊄ to display "FINE" on the screen.
- (5) Press + or - continuously until the above problems are minimized.
The + or - icon on the screen flashes while tuning.
- (6) Press SELECT to return to normal screen.

Watching the TV

This section explains functions used while watching the TV. Most operations can be done using the remote.

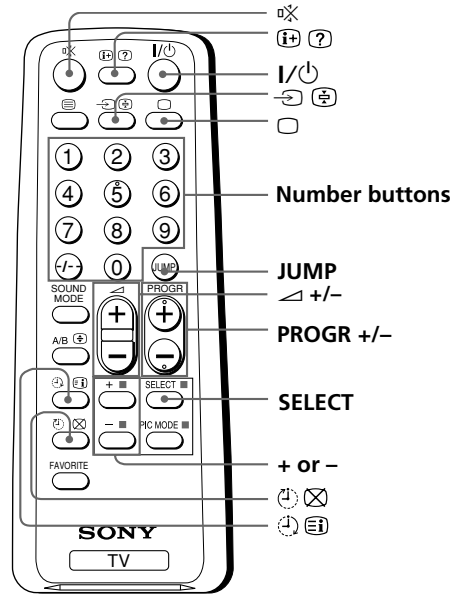
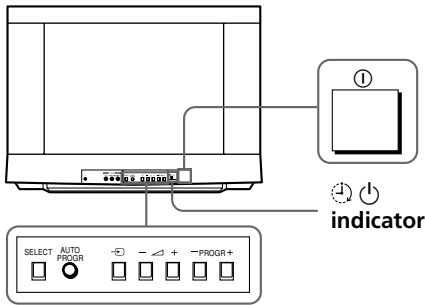

1 Press ① to turn on the TV.

When the TV is in the standby mode (the ⏻ indicator on the TV is lit red), press I/⏻ on the remote or PROGR +/- on the TV.



2 Press PROGR +/- or the number buttons to select the program number.

For double digit numbers, press +/-, then the number (e.g., for 25, press +/-, then 2 and 5).

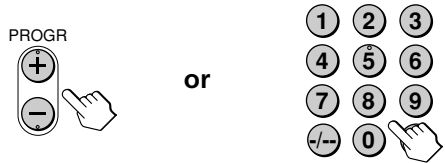

3 Press ⏮ +/- to adjust the volume.



Additional tasks

To	Press
Turn off temporarily	I/⏻. The ⏻ indicator on the TV lights up red.
Turn off completely	Ⓛ on the TV.
Mute the sound	🔇.
Watch the video input (VCR, camcorder, etc.)	↔ to select "VIDEO 1" or "VIDEO 2". To return to the TV program, press □.
Jump back to the previous program number	JUMP.
Display the on-screen information*	ⓘ.
Adjust the volume of all program numbers automatically	SELECT repeatedly until "INTELLIGENT VOL" appears, then press + or - to select "ON". To cancel, select "OFF".
Adjust the picture position when it is not aligned to the TV screen	SELECT repeatedly until "PIC ROTATION" appears, then press + or - to adjust the alignment of the picture position.

PIC ROTATION ⬇️⬅️⬆️⬇️

The ⬇️⬅️ or ⬆️⬇️ icon on the screen flashes while adjusting.

- * The picture, sound, and either the program number or video input are displayed. The on-screen display for the picture and sound information disappears after about three seconds.

Changing the on-screen display language

- 1** Press SELECT until "LANGUAGE / اللغة : ENGLISH" appears on the screen.



LANGUAGE / اللغة : ENGLISH

- 2** Press + or - to select "عربي".

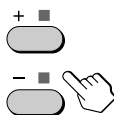

LANGUAGE / اللغة : عربي

Tip

- You can also use SELECT and ⏻ +/− on the TV to select the on-screen display language.

continued

Watching the TV (continued)

Setting the Wake Up timer

- 1 Press  until the desired period of time appears.
The Wake Up timer starts immediately after you have set it.

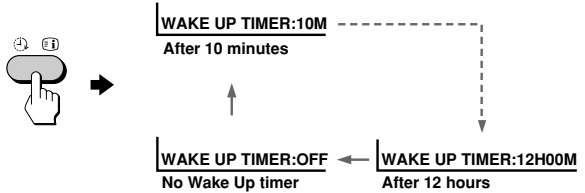

- 2 Select the program number or video input you want to display when you wake up.
- 3 Press I/⏻ or set the Sleep timer if you want the TV to turn off automatically.
The  indicator on the TV lights up orange.

To cancel the Wake Up timer

Press  until “WAKE UP TIMER: OFF” appears or turn off the TV’s main power.

Note

- If no buttons or controls are pressed for more than two hours after the TV is turned on using the Wake Up timer, the TV automatically goes into the standby mode. To continue watching the TV, press any button or control on the TV or the remote.

Setting the Sleep timer

- Press  until the desired period of time appears.
The Sleep timer starts immediately after you have set it.

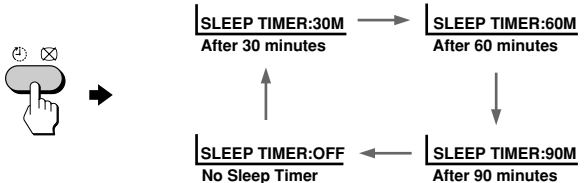

To cancel the Sleep timer

Press  until “SLEEP TIMER: OFF” appears or turn the TV off.

Customizing the picture and sound

You can customize the picture and sound by selecting the picture and sound modes or by adjusting its settings.

You can change the sound effect by selecting the surround mode.

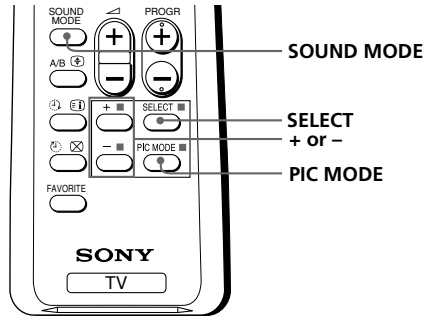

Selecting the picture and sound modes

To select the picture mode

Press PIC MODE repeatedly until you get the desired picture mode.

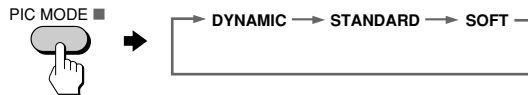

Select	To
"DYNAMIC"	receive high contrast pictures.
"STANDARD"	receive normal contrast pictures.
"SOFT"	receive mild pictures.

To select the sound mode

Press SOUND MODE repeatedly until you get the desired sound mode.



Select	To
"DYNAMIC"	listen to dynamic and clear sound that emphasizes the low and high sound.
"DRAMA"	listen to sound that emphasizes vocals and background music.
"SOFT"	receive soft sound.

continued

Customizing the picture and sound (continued)

Adjusting the picture and sound settings

- 1 Press SELECT until the desired setting appears.

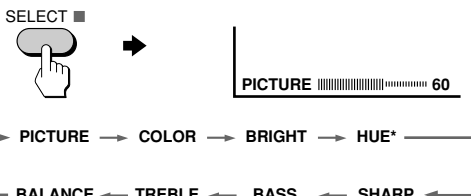

Each time you press SELECT, the setting item will change as follows:

- 2 Press + or – to adjust the item.

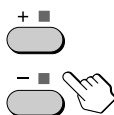

- 3 To adjust other items, repeat steps 1 to 2.

* "HUE" can be adjusted for the NTSC system only.

Notes

- When you select a picture or sound mode, the adjusted settings will be reset according to the selected mode.
- You can also use SELECT and +/- on the TV to adjust the picture and sound settings.

Selecting the surround mode

- 1 Press SELECT repeatedly until "SURROUND" appears.

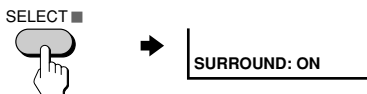

- 2 Press + or – to select "ON".
To turn off the surround mode, select "OFF".

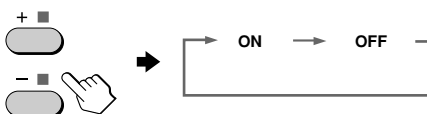

Viewing your favorite channels

You can display six of your favorite channels for quick and easy selection. You can program the favorite channel setting as well.

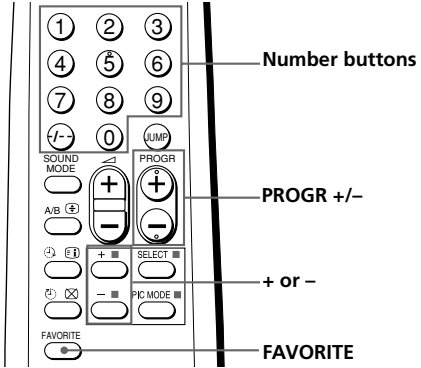

Selecting a favorite channel

1 Press FAVORITE.



2 Press the number button from 1 to 6 to select the desired favorite channel.

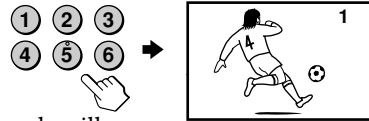

When you use the “FAVORITE CH” feature for the first time, six preset favorite channels will appear.

Programming the favorite channel

1 Press PROGR +/- or number buttons to select the program number you want to program (e.g., program number 8).

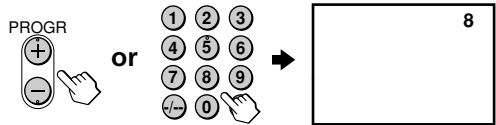

2 Press SELECT until “FAVORITE CH SETUP” appears.

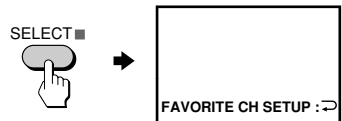

3 Press + or - to select the favorite channel you want to program (e.g., ③).

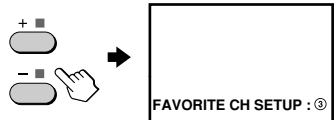

4 Press SELECT.
The selected favorite channel (e.g., ③) turns red for about one second.



5 To program other favorite channels, repeat steps 1 to 4.

Blocking the channels (CHILD LOCK)

You can lock some program numbers to prevent children from watching certain channels, by using the buttons on the remote control.

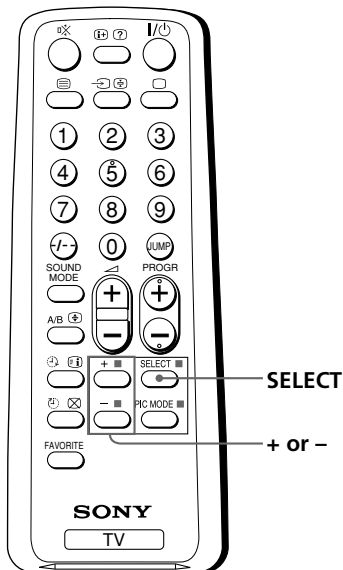



1 Select the program number you want to lock.

2 Press SELECT until "CHILD LOCK" appears on the screen.



3 Press + or – to select "ON".

The  symbol appears on the screen.

To cancel, press + or – to select "OFF". The  symbol disappears from the screen.

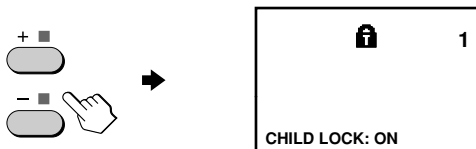

Note

- If you preset a locked program number, that particular program number will be unlocked automatically (see page 10).

Enjoying stereo or bilingual programs

(KV-XA21M93 only)

You can enjoy stereo sound or bilingual programs of NICAM and A2 stereo systems.

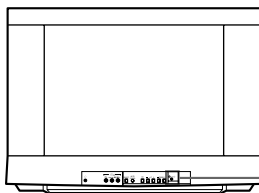

 indicator

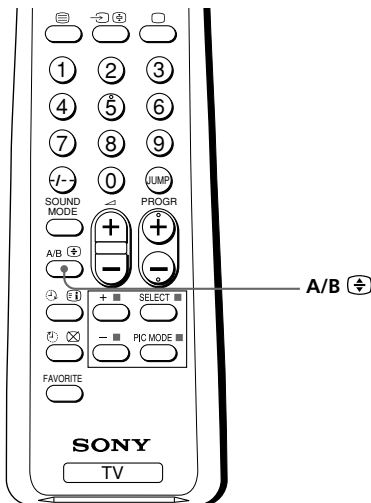

Press A/B repeatedly until you receive the sound you want.

The on-screen display changes to show the selected sound.

The  indicator on the TV lights up red when receiving any stereo or bilingual program.

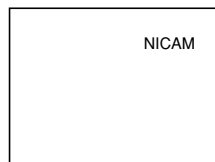
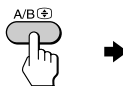

When receiving a NICAM program

Broadcasting

On-screen display (Selected sound)

NICAM stereo



NICAM bilingual

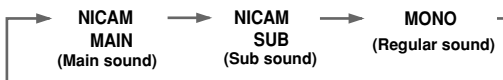

NICAM monaural



continued

Enjoying stereo or bilingual programs (continued)

When receiving an A2 program

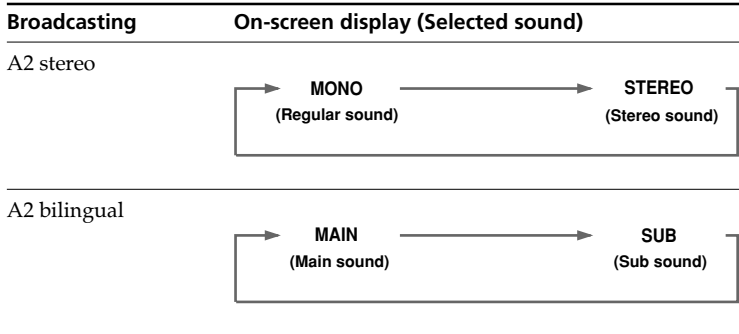

Notes

- If the signal is very weak, the sound becomes monaural automatically.
- If the stereo sound is noisy when receiving a NICAM program, select "MONO". The sound becomes monaural, but the noise is reduced.

If the sound is distorted when receiving a monaural program through the \sqcap (antenna) terminal

Press A/B repeatedly until "MONO" appears on the screen.

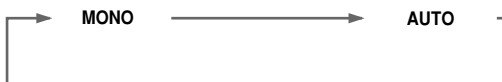

To cancel the monaural sound setting, press A/B again until "AUTO" appears on the screen.







Notes

- The "MONO" or "AUTO" setting is memorized for each program number.
- You cannot receive stereo broadcast signal when the TV is in the "MONO" setting. Normally set the TV to "AUTO".

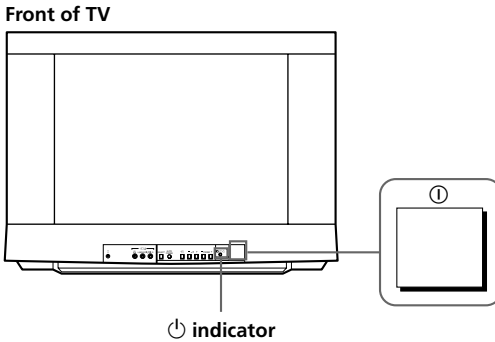
Self-diagnosis function









Your TV is equipped with a self-diagnosis function. If there is a problem with your TV, the  indicator flashes red. The number of times the  indicator flashes indicates the possible causes.

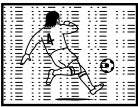







- 1** Check that the  indicator flashes red a number of times between 3-second intervals.
- 2** Count the number of times the  indicator flashes.
- 3** Press  (main power) to turn off your TV.
- 4** Inform your nearest Sony service center about the number of times the  indicator flashes.
Be sure to note the model name and serial number located on the rear of your TV.

Troubleshooting



If you find any problem while viewing your TV, please check the following guide.
If any problem persists, contact your Sony dealer.

Symptom	Possible cause	Solutions	Page
Snowy picture 	<ul style="list-style-type: none"> • Connection is loose or the cable is damaged. • Channel presetting is inappropriate or incomplete. 	<ul style="list-style-type: none"> • Check the antenna cable and connection on the TV, VCR and on the wall. • Press SELECT until "MANUAL PROGRAM" appears on the screen, then preset the channel again. 	<p>4</p> <p>10</p>
Noisy sound 	<ul style="list-style-type: none"> • The antenna type is inappropriate. • The antenna direction is inappropriate. • Signal transmission is low. 	<ul style="list-style-type: none"> • Check the antenna type (VHF/UHF). Contact a Sony dealer for advice. • Adjust the antenna direction. Contact a Sony dealer for advice. • Try using a booster. 	<p>–</p> <p>–</p> <p>–</p>
Distorted picture 	<ul style="list-style-type: none"> • Broadcast signals are too strong. 	<ul style="list-style-type: none"> • Turn off or disconnect the booster if it is in use. 	<p>–</p>
Noisy sound 			
Good picture 	<ul style="list-style-type: none"> • The TV system setting or channel presetting is inappropriate or incomplete. 	<ul style="list-style-type: none"> • If the sound of all the channels are noisy, check the TV system (TV SYS) setting, then press AUTO PROGR to preset the channels again. • If the sound of some channels are noisy, select the channel, then select the appropriate TV system (TV SYS). 	<p>9</p> <p>10</p>
Noisy sound 	<ul style="list-style-type: none"> • The selected sound is inappropriate. 	<ul style="list-style-type: none"> • If the sound of some channel are noisy, select the channel, then press A/B to select the main sound (KV-XA21M93 only). 	<p>19</p>
No picture 	<ul style="list-style-type: none"> • The power cord, antenna or VCR is not connected. • The TV is not turned on. 	<ul style="list-style-type: none"> • Check the power cord, antenna and the VCR connections. • Press I/⏻ (power). 	<p>4</p> <p>13</p>
No sound 		<ul style="list-style-type: none"> • Press Ⓚ (main power) on the TV to turn off the TV for about five seconds, then turn it on again. 	<p>12</p>

Symptom	Possible cause	Solutions	Page
Good picture 	<ul style="list-style-type: none"> The volume level is too low. 	<ul style="list-style-type: none"> Press $\triangle +$ to increase the volume level. 	12
	<ul style="list-style-type: none"> The sound is muted. 	<ul style="list-style-type: none"> Press \otimes to cancel the muting. 	13
	<ul style="list-style-type: none"> Broadcast signal has a transmission problem. 	<ul style="list-style-type: none"> Press A/B until a better sound is heard (KV-XA21M93 only). 	19
No sound 			
Dotted lines or stripes 	<ul style="list-style-type: none"> There is local interference from cars, neon signs, hair dryers, power generators, etc. 	<ul style="list-style-type: none"> Do not use a hair dryer or other equipment near the TV. Adjust the antenna direction for minimum interference. Contact a Sony dealer for advice. 	–
			–
Double images or "ghosts" 	<ul style="list-style-type: none"> Broadcast signals are reflected by nearby mountains or buildings. 	<ul style="list-style-type: none"> Use a highly directional antenna. Use the fine tuning (FINE) function. 	–
	<ul style="list-style-type: none"> The antenna direction is inappropriate. 	<ul style="list-style-type: none"> Adjust the antenna direction. Contact a Sony dealer for advice. 	–
	<ul style="list-style-type: none"> Use of a booster is inappropriate. 	<ul style="list-style-type: none"> Turn off or disconnect the booster if it is in use. 	–
No color 	<ul style="list-style-type: none"> The color level setting is too low. 	<ul style="list-style-type: none"> Press SELECT until "COLOR" appears on the screen, then press + or – to adjust the color level. 	16
	<ul style="list-style-type: none"> The color system setting is inappropriate. 	<ul style="list-style-type: none"> Press SELECT until "COLOR SYS" appears on the screen, then check the color system setting (usually set this to "AUTO"). 	11
	<ul style="list-style-type: none"> The antenna direction is inappropriate. 	<ul style="list-style-type: none"> Adjust the antenna direction. Contact a Sony dealer for advice. 	–
Abnormal color patches 	<ul style="list-style-type: none"> The magnetic disturbance from external speakers or other equipment, or the direction of the earth's magnetic field may affect the TV. 	<ul style="list-style-type: none"> Keep external speakers or other electrical equipment away from the TV. Do not move the TV while the TV is turned on. Press \odot (main power) on the TV to turn off the TV for about five minutes, then turn it on again. 	–
TV cannot receive stereo broadcast signal (KV-XA21M93 only)	<ul style="list-style-type: none"> The stereo reception setting is inappropriate. 	<ul style="list-style-type: none"> Press A/B until "AUTO" appears on the screen. 	19

continued

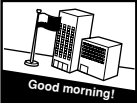
Troubleshooting (continued)

Symptom	Possible cause	Solutions	Page
<p>Stereo broadcast sound switches on and off or is distorted.</p> <p>OR</p> <p>The sound switches between monaural and stereo frequently. (KV-XA21M93 only)</p>	<ul style="list-style-type: none"> • Connection is loose or the cable is damaged. 	<ul style="list-style-type: none"> • Check the antenna cable and connection on the TV, VCR and on the wall. 	4
	<ul style="list-style-type: none"> • The antenna direction is inappropriate. 	<ul style="list-style-type: none"> • Adjust the antenna direction. Contact a Sony dealer for advice. 	—
	<ul style="list-style-type: none"> • Broadcast signal has a transmission problem. 	<ul style="list-style-type: none"> • Press A/B until a better sound is heard. 	19
<p>Picture slant</p> 	<ul style="list-style-type: none"> • The magnetic disturbance from external speakers or other equipment, or the direction of the earth's magnetic field may affect the TV. 	<ul style="list-style-type: none"> • Keep external speakers or other electrical equipment away from the TV. • Press SELECT until "PIC ROTATION" appears on the screen, then press + or - to adjust the picture until it is optimal. 	— 13
<p>Lines moving across the TV screen.</p>	<ul style="list-style-type: none"> • There is interference from external sources, e.g., heavy machineries, nearby broadcast station. 	<ul style="list-style-type: none"> • Use the fine tuning (FINE) function. 	11
<p>The  indicator on your TV flashes red a number of times between 3-second intervals.</p>	<ul style="list-style-type: none"> • Your TV may need service. 	<ul style="list-style-type: none"> • Contact your nearest Sony service center. 	21
<p>TV cabinet creaks.</p>	<ul style="list-style-type: none"> • Changes in room temperature sometimes make the TV cabinet expand or contract, making a noise. This does not indicate a malfunction. 	—	—
<p>A "boom" sound is heard when the TV is turned on.</p>	<ul style="list-style-type: none"> • The TV's demagnetizing function is working. This does not indicate a malfunction. 	—	—

Overview of controls

TV front panel

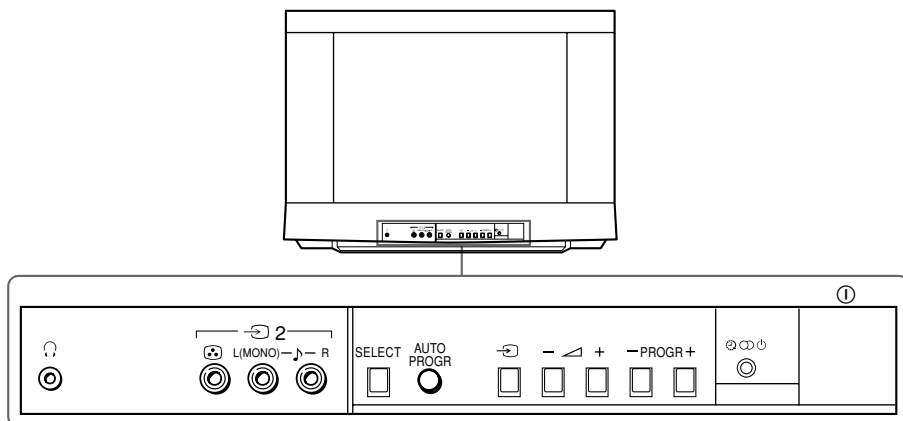

Button	Function	Page
AUTO PROGR	Preset channels automatically.	5
SELECT	Select the desired item.	11
PROGR +/-	Select program number.	12
Ⓛ	Turn off completely or turn on the TV.	12
∇ +/-	Adjust volume.	12
Ⓜ	Standby indicator.	12
Ⓜ	Select TV or video input.	13
Ⓜ	Wake Up indicator.	14
Ⓜ (KV-XA21M93 only)	Stereo/bilingual indicator.	19
Ⓜ	Headphone jack.	-

continued

Overview of controls (continued)

Remote Control

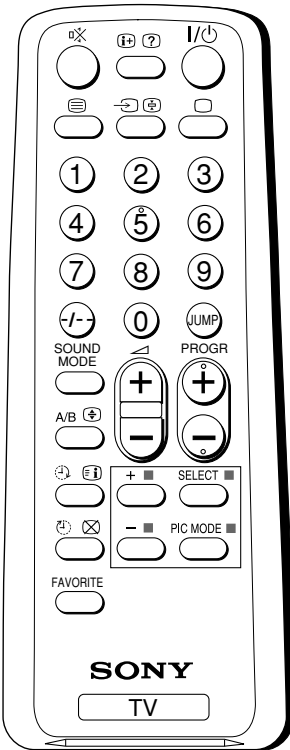



The names/symbols of buttons on the remote are indicated in different colors to represent the available functions.

Label color	Button function
White	For general TV operations
Green	For Teletext operations

Button	Function	Page
SELECT	Select the desired item.	10
+/-	Adjust value.	10
PROGR +/-	Select program number.	12
0 - 9, -/--	Input numbers.	12
△ +/-	Adjust volume.	12
I/⏻	Turn off temporarily or turn on the TV.	12
↶	Select TV or video input.	13
☐	Display the TV program.	13
⊗	Mute the sound.	13
Ⓜ	Display on-screen information.	13
JUMP	Jump to previous program number.	13
Timer operations		
⌚	Set TV to turn on automatically.	14
⌚	Set TV to turn off automatically.	14
PIC MODE	Select picture mode.	15
SOUND MODE	Select sound mode.	15
FAVORITE	Display favorite channels.	17
Stereo/bilingual operations (KV-XA21M93 only)		
A/B	Select stereo/bilingual mode.	19
Teletext operations (Not used for KV-XA21M93/XA21M83)		
☰	Display Teletext broadcast.	-
Ⓜ	Display Teletext service contents.	-
Ⓜ	Stop Teletext display from scrolling.	-
?	Reveal concealed information.	-
Ⓜ	Enlarge the Teletext display.	-
⊗	Show TV screen while waiting for Teletext page.	-
■ (red, green, yellow, blue)	Access a FASTEXT menu.	-

Specifications

	KV-XA21M93 KV-XA21M83	Note
Power requirements	110-240 V AC, 50/60 Hz	
Power consumption (W)	Indicated on the rear of the TV	
Television system	B/G, I, D/K, M	
Color system	PAL, PAL 60, SECAM, NTSC3.58, NTSC4.43,	
Stereo/Bilingual system	Nicam Stereo/Bilingual B/G, I, D/K ; A2 Stereo/Bilingual B/G	KV-XA21M93 only
Channel coverage		
B/G	VHF : E2 to E12 UHF: E21 to E69 CATV : S01 to S03, S1 to S41	
I	UHF : B21 to B68 CATV : S01 to S03, S1 to S41	
D/K	VHF: C1 to C12, R1 to R12 UHF : C13 to C57, R21 to R60 CATV : S01 to S03, S1 to S41, Z1 to Z39	
M	VHF : A2 to A13 UHF: A14 to A79 CATV : A-8 to A-2, A to W+4, W+6 to W+84	
⌚ (Antenna)	75-ohm external terminal	
Audio output (Speaker)	3W + 3W	
3D WOOFER	9W	
Number of terminal		
 (Video)	Input: 2 Output: 1 Phono jacks; 1Vp-p, 75 ohms	
 (Audio)	Input: 2 Output: 1 Phono jacks; 500 mVrms	
 (Headphone)	Output: 1	Stereo minijack
Picture tube	21 in.	
Tube size (cm)	54	Measured diagonally
Screen size (cm)	51	Measured diagonally
Dimensions (w/h/d, mm)	620 x 482 x 496	
Mass (kg)	28	

Design and specifications are subject to change without notice.