

Compact Component System

Operating Instructions

Owner's Record

The model and serial numbers are located on the rear of the system. Record the serial number in the space provided below. Refer to them whenever you call upon your Sony dealer regarding this product.

Model No. _____ Serial No. _____



CMT-EX1

WARNING

To prevent fire or shock hazard, do not expose the unit to rain or moisture.

To avoid electrical shock, do not open the cabinet. Refer servicing to qualified personnel only.

Do not install the appliance in a confined space, such as a bookcase or built-in cabinet.



This appliance is classified as a CLASS 1 LASER product. The CLASS 1 LASER PRODUCT MARKING is located on the bottom exterior.

Except for North American model: The following caution label is located inside the unit.



NOTICE FOR THE CUSTOMERS IN THE U.S.A.

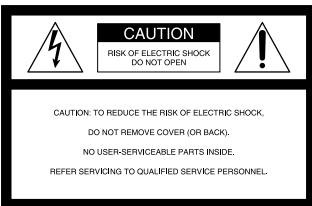

This symbol is intended to alert the user to the presence of uninsulated "dangerous voltage" within the product's enclosure that may be of sufficient magnitude to constitute a risk of electric shock to persons.



This symbol is intended to alert the user to the presence of important operating and maintenance (servicing) instructions in the literature accompanying the appliance.

CAUTION

The use of optical instruments with this product will increase eye hazard.

The shielded interface cable recommended in this manual must be used with this equipment in order to comply with limits for a digital device pursuant to Subpart B of Part 15 FCC Rules.

INFORMATION

This equipment has been tested and found to comply with the limits for a Class B digital device, pursuant to Part 15 of the FCC Rules. These limits are designed to provide reasonable protection against harmful interference in a residential installation. This equipment generates, uses, and can radiate radio frequency energy and, if not installed and used in accordance with the instructions, may cause harmful interference to radio communications. However, there is no guarantee that interference will not occur in a particular installation. If this equipment does cause harmful interference to radio or television reception, which can be determined by turning the equipment off and on, the user is encouraged to try to correct the interference by one or more of the following measures:

- Reorient or relocate the receiving antenna.
- Increase the separation between the equipment and receiver.
- Connect the equipment into an outlet on a circuit different from that to which the receiver is connected.
- Consult the dealer or an experienced radio/TV technician for help.

CAUTION

You are cautioned that any changes or modifications not expressly approved in this manual could void your authority to operate this equipment.

Note to CATV system installer:

This reminder is provided to call CATV system installer's attention to Article 820-40 of the NEC that provides guidelines for proper grounding and, in particular, specifies that the cable ground shall be connected to the grounding system of the building, as close to the point of cable entry as practical.

NOTICE FOR THE CUSTOMERS IN CANADA

CAUTION:

TO PREVENT ELECTRIC SHOCK, DO NOT USE THIS POLARIZED AC PLUG WITH AN EXTENSION CORD, RECEPTACLE OR OTHER OUTLET UNLESS THE BLADES CAN BE FULLY INSERTED TO PREVENT BLADE EXPOSURE.

Table of Contents

Getting Started

Step 1: Hooking up the system	4
Step 2: Setting the time	6
Step 3: Presetting radio stations	7
Saving the power in standby mode	8

Basic Operations

Playing a CD	9
Listening to the radio	10

The CD Player

Playing the CD tracks in random order	
— Shuffle Play	12
Programing the CD tracks	
— Program Play	13
Playing the CD tracks repeatedly	
— Repeat Play	14
Using the CD display	15

Other Features

Generating a more dynamic sound	16
Selecting the surround effect	16
Using the Radio Data System (RDS)	
(European model only)	17
Falling asleep to music	
— Sleep Timer	17
Waking up to music	
— Daily Timer	18

Optional Components

Connecting audio components	20
Listening to the sound of connected	
components	21
Recording a CD on an MD/a tape	22
Connecting external antennas	22

Additional Information

Precautions	23
Troubleshooting	24
Specifications	26
Index	back cover

Step 1: Hooking up the system

Perform the following procedures **1** to **5** to hook up your system using the supplied cords and accessories.

The front cover is made of tempered glass. Please remember to handle this unit carefully.

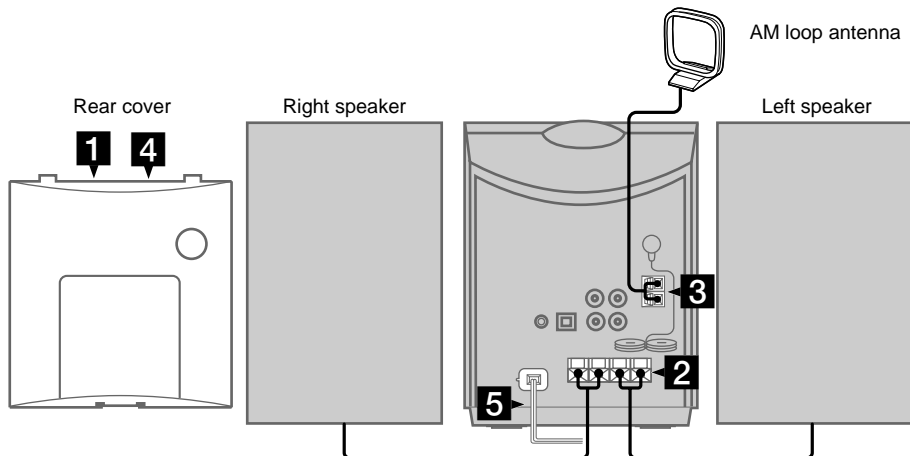

1 Remove the rear cover.

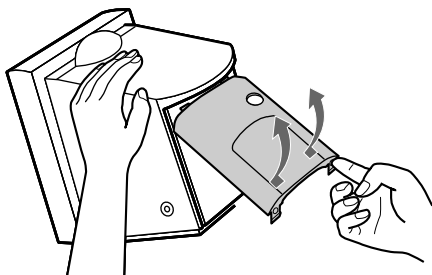

Push in on the tabs
and pull up the cover

2 Connect the speakers.

Connect the speaker cords to the SPEAKER terminals as shown below.

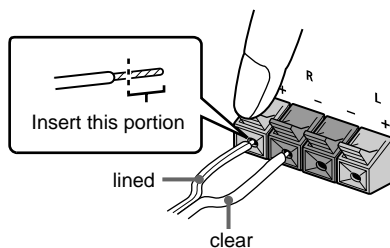

Notes

- Keep the speaker cords away from the antenna to prevent noise.
- Be sure to connect both left and right speakers. Otherwise, the sound will not be heard.

3 Connect the AM antenna.

Set up the AM loop antenna, then connect it. Connect the white cord to the \hbar terminal, and the red cord to the other terminal.

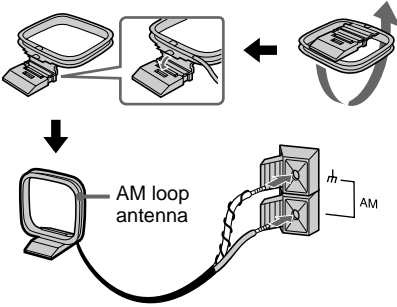
**Note**

Keep the antenna away from the speaker cords to prevent noise.

4 Reinstall the rear cover.

Put the wires through the hole at the bottom of the rear cover.

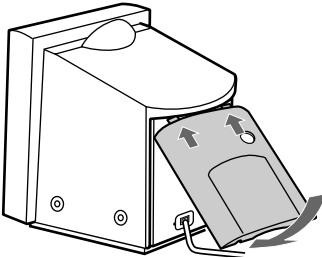
**5** Connect the AC power cord to a wall outlet after you complete all the connections.**Note on the glass cover of CD player**

The CD player cover is made of tempered glass. Under normal conditions, this tempered glass is more shock resistant and able to bear more weight than ordinary glass. This glass, however, may shatter if it receives a sharp blow or if it is scratched.

To level the speakers

Attach the supplied speaker legs to the rear of the speaker bottoms to level the speakers.

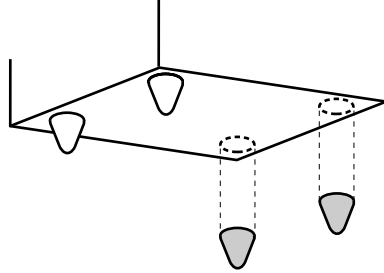
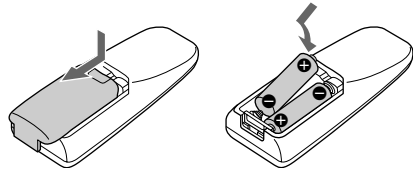
**Inserting two R6 (size AA) batteries into the remote****Tip**

With normal use, the batteries should last for about six months. When the remote no longer operates the system, replace both batteries with new ones.

Note

If you do not use the remote for a long period of time, remove the batteries to avoid possible damage from battery leakage.

To connect optional component
See "Optional Components" on page 20.

Step 2: Setting the time

You must set the time before you can use the timer functions.

The clock is on a 24-hour system for the European model, and a 12-hour system for other models.

The 24-hour system model is used for illustration purpose.

Set the time before turning the power on.

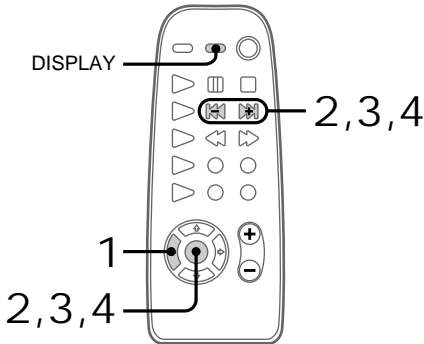

- 1 Press **TIMER SET** while the power is off.

The day indication flashes after “**CLOCK SET**” flashing.



- 2 Press **+/-** to set the day then press **ENTER**.

The hour indication flashes.

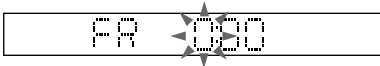

- 3 Press **+/-** to set the hour then press **ENTER**.

The minute indication flashes.



- 4 Press **+/-** to set the minute then press **ENTER**.

The clock starts.

To change the time

You can change the preset time while the power is on.

- 1 Press **TIMER SET**.
- 2 Press **+/-** repeatedly until “**CLOCK SET**” appears then press **ENTER**.
- 3 Repeat steps 2 to 4.

To show the time

You can display the clock any time.

Press **DISPLAY** repeatedly until the clock display appears.

Tips

- If you have made a mistake, start over from step 1.
- The built-in clock shows the time in the display while the power is off.
- The upper dot flashes for the first half of a minute (0 to 29 seconds), and the lower dot flashes for the last half of a minute (30 to 59 seconds).

Step 3: Presetting radio stations

You can preset the following number of stations:
– 20 for FM, 10 for AM.

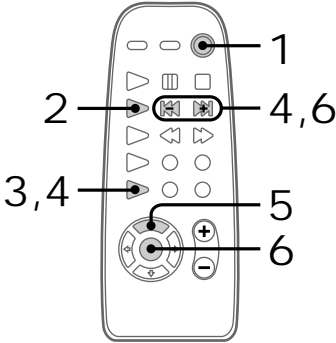

- 1** Press I/O to turn on the system.
- 2** Press TUNER/BAND repeatedly until the band you want appears in the display.
Each time you press the button, the band changes as follows:
FM ↔ AM
- 3** Press TUNING MODE repeatedly until “AUTO” appears.
- 4** Press +/- (or TUNING +/- on the unit).
The frequency indication changes and scanning stops when the system tunes in a station. “TUNED” and “STEREO” (for a stereo program) appear. When you want to stop scanning, press TUNING MODE.

- 5** Press MEMORY.
A preset number flashes.
Proceed to step 6 while the preset number is flashing. If the unit is not operated for more than 16 seconds, the preset number disappears and the unit returns to the status of step 3. If this happens, start over from step 4.

- 6** Press +/- to select the preset number you want then press ENTER.
The station is stored.
Select 1 to 20 for FM, and select 1 to 10 for AM.
- 7** Repeat steps 2 to 6 to preset other stations.

To tune in the station manually

- 1** Press TUNING MODE repeatedly until “MANUAL” appears in step 3.
- 2** Press +/- (or TUNING +/- on the unit) repeatedly to tune in the station and continue from step 5.

To change the preset number

Start over from step 2.

continued

Step 3: Presetting radio stations (continued)

To change the AM tuning interval (except for European model)

The AM tuning interval is factory-set to 9 kHz (10 kHz in some areas). To change the AM tuning interval, tune in any AM station first, then turn off the power. While holding down the TUNING + button, turn the power back on. When you change the interval, all the AM preset stations are erased. To reset the interval, repeat the same procedure.

Tips

- When a new station is memorized, the station formerly memorized at that preset number is erased.
- The preset stations are retained for a week even if you disconnect the AC power cord or if a power failure occurs.
- If noise is heard while listening to an FM station, remove the FM antenna from the rear panel and place the antenna outside the cabinet.

Saving the power in standby mode

You can lower the power consumption to a minimum (Power Saving Mode) and save energy in the standby mode.

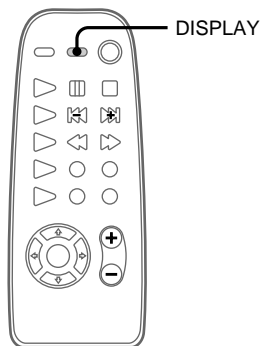

-
- ➔ Press **DISPLAY** when the power is off.
The unit switches to the Power Saving Mode and the clock display disappears.
The system turns on/off by pressing **I/⏻**.
-

To cancel the Power Saving Mode

Press **DISPLAY**.
The clock display appears.

Notes

- When the Daily Timer is set, you cannot switch to the Power Saving Mode.
- When the Daily Timer is set in the Power Saving Mode, the Power Saving Mode does not function until the timer is canceled.

Playing a CD

To turn on the system, press I/⏻ (Power)

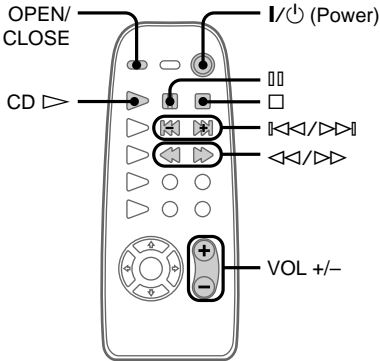
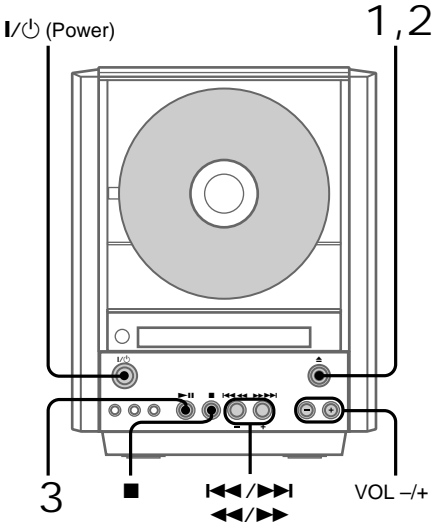

- 1 Touch ▲ (or press OPEN/CLOSE on the remote) to raise the disc tray.
- 2 Place a CD vertically in the tray.

With the label side front. When you play a 8 cm CD, use the optional adaptor.

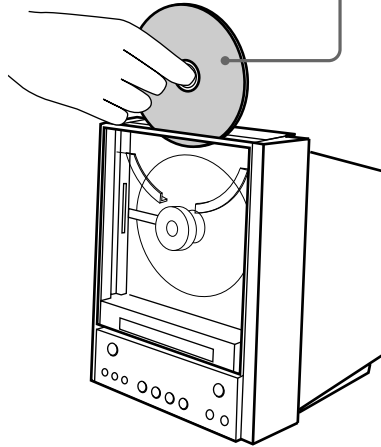

To lower the disc tray, touch ▲ (or press OPEN/CLOSE on the remote) again.

- 3 Press ▶|| (or CD ▷ on the remote). Play starts.



continued

Playing a CD (continued)

To	Do this
Stop play	Press ■.
Pause	Press ► (or on the remote). Press again to resume play.
Select a track	Press ◀◀/▶▶ repeatedly until you find the desired track.
Find a point in a track	Press and hold ◀◀/▶▶ during play, and release it at the desired point.
Remove CD	Touch ▲ (or press OPEN/CLOSE on the remote).
Adjust the volume	Press VOL +/-.

Tips

- You can switch from another source to the CD player and start playing a CD by pressing ►|| (or CD ▷ on the remote) (Automatic Source Selection).
- If you press ►|| (or CD ▷ on the remote) while the power is off, the power turns on and play starts automatically (One Touch Play).
- If you touch ▲ while the power is off, the power turns on, the function switches to CD, then the disc tray rises automatically.
- To listen through the headphones, connect the headphones to the PHONES jack on the rear panel.

Notes

- Do not forcibly press the disc down with your finger, as this may cause CD player trouble. Furthermore, do not obstruct the ejecting CD. Be sure to touch ▲ (or press OPEN/CLOSE on the remote) to lower the disc tray.
- Do not push strongly on ▲, as this may damage the player.
- The disc tray will not operate if you touch ▲ while wearing gloves. Touch ▲ with bare hands or press OPEN/CLOSE on the remote.

Listening to the radio

Preset radio stations in the tuner's memory first (see page 7). To turn on the system, press I/⏻

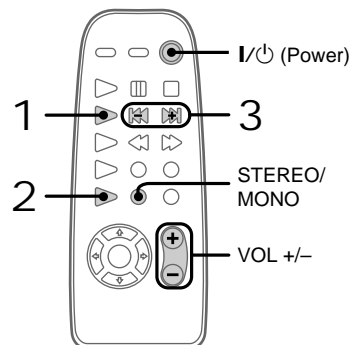
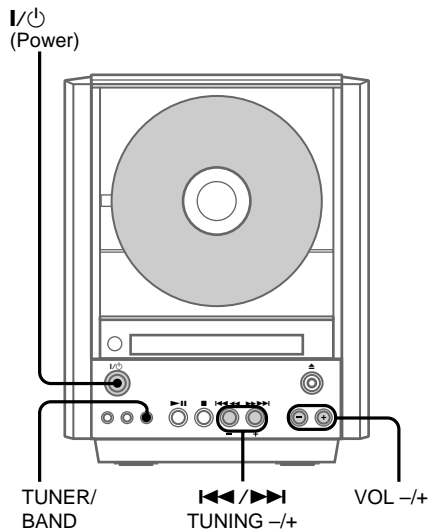

1 Press TUNER/BAND repeatedly until the band you want appears.

Each time you press the button, the band changes as follows:

FM ↔ AM



2 Press TUNING MODE repeatedly until “PRESET” appears.



3 Press ◀◀/▶▶ to select the desired station’s preset number.



To cancel the Automatic Tuning
Press TUNING MODE.

Tips

- You can switch from another source to the tuner by pressing TUNER/BAND (Automatic Source Selection).
- If you press TUNER/BAND while the power is off, the power turns on and the system tunes in the last received station automatically (One Touch play).
- To improve broadcast reception, reorient the supplied antennas or connect an optional external antenna.
- When an FM program has static noise, press STEREO/MONO until “MONO” appears. There will be no stereo effect, but the reception will improve. Press again to restore the stereo effect.

To	Do this
Turn off the radio	Press I/⏻ to turn off the system.
Adjust the volume	Press VOL +/-.

To listen to non-preset radio stations

- Press TUNING MODE repeatedly until “MANUAL” appears in step 2, then press +/- (or TUNING +/- on the unit) repeatedly to tune in the desired station (Manual Tuning).
- Press TUNING MODE repeatedly until “AUTO” appears in step 2, then press +/- (or TUNING +/- on the unit). The frequency indication changes and scanning stops when the system tunes in a station (Automatic Tuning).

Playing the CD tracks in random order -- *Shuffle Play*

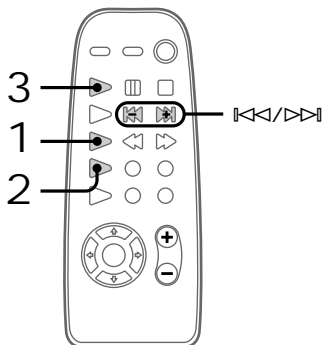

You can play all the tracks on a CD in random order.



1 Press FUNCTION repeatedly until “CD” appears.

2 Press CD PLAY MODE repeatedly until “SHUF” appears.





3 Press CD .
Shuffle Play starts. “” appears, and all the tracks play in random order.

To cancel Shuffle Play

Press CD PLAY MODE repeatedly until “SHUF” and “PGM” disappear from the display. The tracks continue playing in their original order.

Tips

- If you press CD PLAY MODE repeatedly until “SHUF” appears during normal play, all the tracks are played in random order.
- To skip a track, press .
Press  to go back to the beginning of the current track. However, you cannot go back to the previous track.

Programming the CD tracks -- Program Play

You can make a program up to 24 tracks in the order you want them to be played.

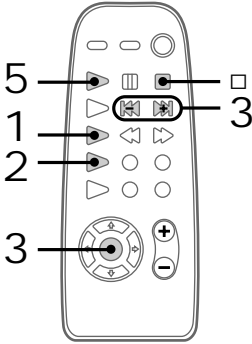

- 1 Press FUNCTION repeatedly until “CD” appears.
- 2 Press CD PLAY MODE repeatedly until “PGM” appears.
- 3 Press \lll / \ggg until the desired track number appears, then press ENTER.
- 4 To program additional tracks, repeat step 3.
Each time you program, the total time of the program and the last selected track number are displayed. You can make a program up to 24 tracks.

- 5 Press CD \triangleright .
All the tracks play in the order you selected.

To cancel Program Play

Press CD PLAY MODE repeatedly until “PGM” and “SHUF” disappear from the display.

To change the program

You can change the program before you start playback.

To	Do this
Clear the entire program	Do steps 1 and 2, then press \square in stop mode.
Add a track to the program	Do step 3.

Tips

- The program you made remains after Program Play finishes. To play the same program again, press CD \triangleright .
- When the total playing time has exceeded 100 minutes, the time is not displayed and the total number of programmed tracks is displayed.
- If you try to add more than the maximum number of tracks possible, “STEP FULL” appears.

Playing the CD tracks repeatedly -- Repeat Play

You can repeat a CD in normal play, Shuffle Play and Program Play.

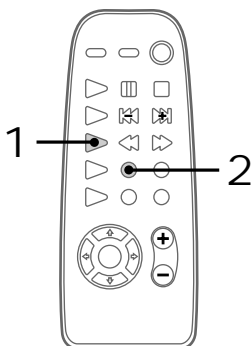

To cancel Repeat Play
Press REPEAT until "REP" or "REP 1"
disappears from the display.

- 1 Press FUNCTION repeatedly until "CD" appears.
- 2 Press REPEAT during play until "REP" or "REP 1" appears.

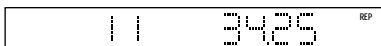

REP: For all the tracks on the CD;

Play mode	Repeat
Normal	All the tracks in their original order
Shuffle (page 12)	All the tracks in random order
Program (page 13)	All the programmed tracks in order

REP 1* : For a single track only.

* You cannot repeat only one track during Shuffle Play and Program Play.

Using the CD display

You can check the total number of tracks, the total playing time, and the remaining time of the track or the CD.

When a CD TEXT disc is loaded, you can check the information stored on the CD, such as the titles or artist names.

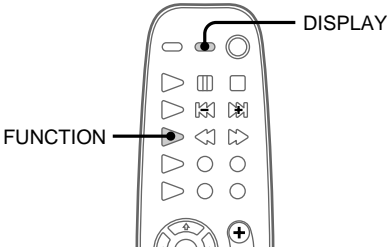

Checking the total playing time

- 1 Press FUNCTION repeatedly until "CD" appears.
- 2 While the disc is stopped, press DISPLAY repeatedly.
Each time you press the button, the display changes as follows:

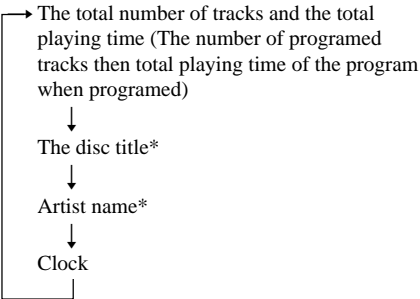

* With CD TEXT discs only.

Checking the remaining time

- Press DISPLAY repeatedly during play.
Each time you press the button, the display changes as follows:

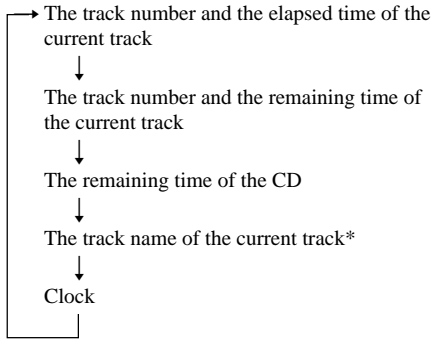

* With CD TEXT discs only (certain characters cannot be displayed). When the CD contains more than 20 tracks, CD TEXT is not displayed from track 21 on.

Generating a more dynamic sound

The Dynamic Sound Generator (DSG) automatically enhances your music to produce a more powerful sound.

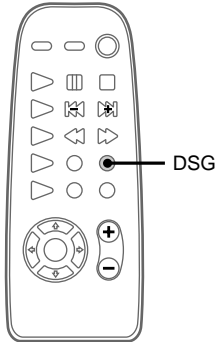

➔ Press DSG.

Each time you press the button, the display changes as follows:

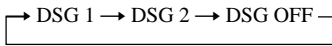

When DSG is ON, "DSG" lights up in the display.

To cancel DSG

Press DSG repeatedly to turn off "DSG."

Selecting the surround effect

You can enjoy the encompassing effects of surround sound.

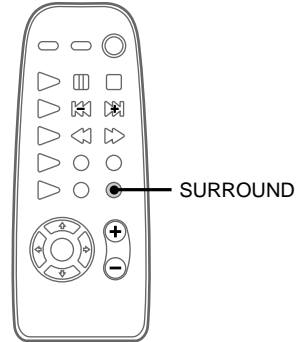

➔ Press SURROUND.

Each time you press the button, the display changes as follows:

SURR ON ↔ SURR OFF

When SURROUND is ON, "SURR" lights up in the display.

To cancel SURROUND

Press SURROUND to turn off "SURR."

Using the Radio Data System (RDS)

(European model only)

What is the Radio Data System?

Radio Data System (RDS) is a broadcasting service that allows radio stations to send additional information along with the regular program signal.

Note

RDS may not work properly if the station you have tuned in is not transmitting the RDS signal properly or if the signal is weak.

* Not all FM stations provide RDS service, nor do they all provide the same types of services. If you are not familiar with the RDS system, check with your local radio stations for details on RDS services in your area.

Receiving RDS broadcasts

➔ Simply select a station from the FM band.

When you tune in a station that provides RDS services, the station name appears in the display.

To check the RDS information

Each time you press DISPLAY, the display changes as follows:

Station name* ↔ Frequency

* If the RDS broadcast is not properly received, the station name may not appear in the display.

Falling asleep to music

— Sleep Timer

You can set the system to turn off after a certain amount of time, so that you can fall asleep to music. You can set the timer in 10 minutes increments.

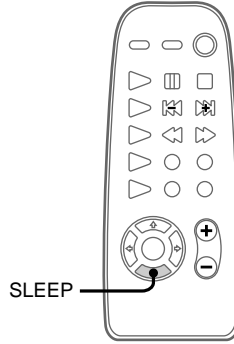

➔ Press SLEEP repeatedly to select a desired time.

Each time you press the button, the minute display (the amount of time after which the system turns off) changes as follows:



After a few seconds, the previous display appears. "SLEEP" lights up in the display.

When you choose "AUTO," the system turns off after the CD finishes playback (up to 100 minutes). The system also turns off when you manually stop playing the CD.

continued

Falling asleep to music (continued)

To check the remaining time

Press SLEEP once.

To change the remaining time

Press SLEEP repeatedly to select the time you want.

To cancel the Sleep Timer function

Press SLEEP repeatedly until "OFF" appears.

Tip

You can use the Sleep Timer, even if you have not set the clock.

Note

When the Sleep Timer is used, you cannot use the Daily Timer.

Waking up to music

— Daily Timer

You can wake up to music at a preset time. Make sure you have set the clock (see page 6).

To wake up to the radio, preset the radio stations first (see page 7).

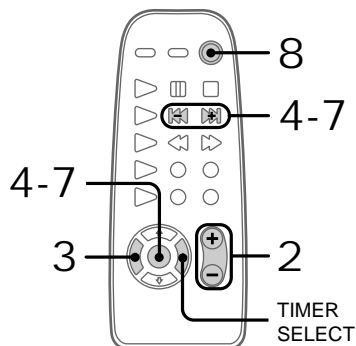

-
- 1 Prepare the music source you want to play.
 - CD: Place a CD. To start from a specific track, make a program (see page 13).
 - Radio: Tune in a preset radio station (see page 10).
 - Tape: Make the same setting on the timer of the component connected to the TAPE jacks.
 - 2 Press VOL +/- to adjust the sound volume.
 - 3 Press TIMER SET.
-

-
- 4 Press +/- repeatedly until “TIMER SET” appears then press ENTER.

The hour indication flashes.

- 5 Set the time to start playback.
Press +/- to set the hour, then press ENTER.
The minute indication flashes.



Press +/- to set the minute, then press ENTER.

The hour indication flashes again.

-
- 6 Set the time to stop playback following the procedure in step 5.

The music source indication flashes.

-
- 7 Press +/- repeatedly until the music source you want appears.

The indication changes as follows:

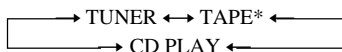

If you press ENTER, the start time, followed by the stop time, the music source appears, then the original display appears. “DAILY” lights up in the display.

* Select “TAPE” to use an optional component connected to the TAPE jacks as the music source.

-
- 8 Press I/⏻ to turn off the system.

The Daily Timer is set. At the selected time, the system turns on automatically and the assigned music source begins playback.

When the time is over, the system turns off and resets the Daily Timer.

To change the setting

Start over from step 1.

To check the setting / To use the timer

Press TIMER SELECT to indicate “DAILY”. The start time, followed by the stop time, the music source appears, then the original display appears.

To cancel the timer

Press TIMER SELECT to indicate “TIMER OFF”.

Tip

To reset the Daily Timer with the same settings, press TIMER SELECT repeatedly until “DAILY” appears in the display and then turn off the system. It is not necessary to set the start and stop times every time.

Connecting audio components

To enhance your system, you can connect optional components. Refer to the instructions of each component.

To connect optional components, remove the small rear cover first.

Connecting an MD deck for digital recording

You can record from CD into the MD deck digitally by connecting an optional cable (not supplied).

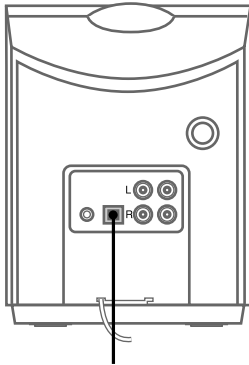

To the DIGITAL IN jack of the MD deck

Connecting an MD deck or a tape deck for analog recording

Make sure to match the color of the plugs and the connectors.

To listen to the sound of the connected MD deck or tape deck, press FUNCTION repeatedly until "TAPE" appears.

To the audio input of an MD deck or a tape deck

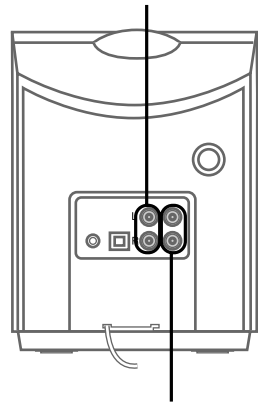

To the audio output of an MD deck or a tape deck

Connecting headphones

Connect headphones to the PHONES jack.

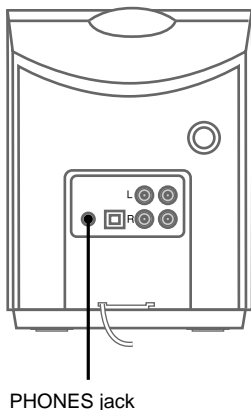

Listening to the sound of connected components

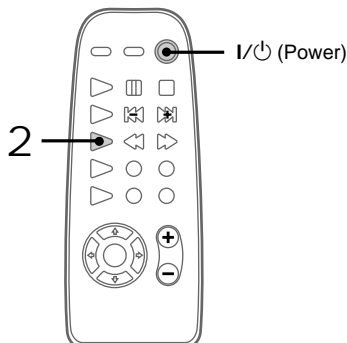

1 Prepare the audio components.

2 Press FUNCTION repeatedly until “TAPE” appears.

Each time you press the button, the function display changes as follows:



To attenuate the distortion from the connected components

You can change the audio input level for the TAPE input jacks between two levels.

If the sound from a connected component is distorted, reduce the input level.

1 Press FUNCTION repeatedly until “TAPE” appears.

2 Press I/⏻ to turn off the system.

3 While holding down ■ on the unit, press I/⏻ on the unit to turn on the system.

“ATT ON” appears in the display.

When the volume is too low, do steps 1 to 3 again to reset to the original level.

Recording a CD on an MD/a tape

For the operations of the connected components, refer to the instructions of each component.

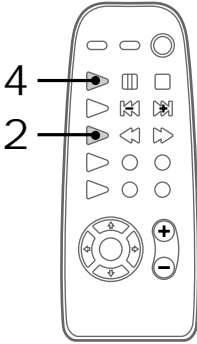

- 1 Prepare the recording component for recording.
- 2 Press FUNCTION repeatedly until "CD" appears.
- 3 Start recording.
- 4 Press CD ▷ .
Play starts.

Connecting external antennas

Remove the rear cover and connect an external antenna to improve the reception. Refer to the instructions of each component.

FM antenna

Connect an optional FM external antenna. You can also use the TV antenna instead.

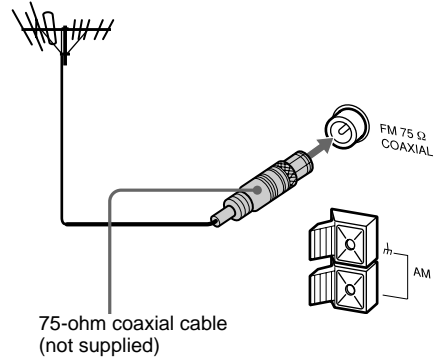

AM antenna

Connect a 6- to 15- meter (20- to 50- feet) insulated wire to the AM antenna terminal.

Leave the supplied AM loop antenna connected.

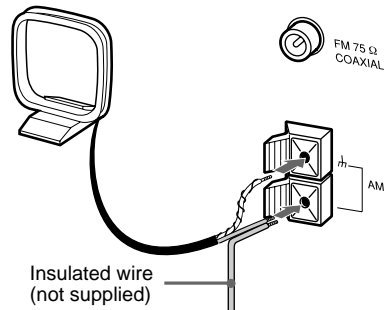

Important

If you connect an external antenna, connect the ground wire and the AM antenna to the *h* terminal. To prevent a gas explosion, do not connect the ground wire to a gas pipe.

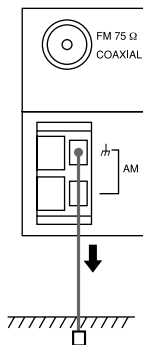

Precautions

The nameplate is located on the bottom exterior.

On safety

- The glass over the display window on the cover is made of tempered glass. Under normal conditions, this tempered glass is more shock resistant and able to bear more weight than ordinary glass. This glass, however, may shatter if it receives a sharp blow or if it is scratched.
- The system is not disconnected from the AC power source (mains) as long as it is connected to the wall outlet, even if the system itself has been turned off.
- Unplug the system from the wall outlet if it is not to be used for an extended period of time. To disconnect the cord (mains lead), pull it out by the plug. Never pull the cord itself.
- Should any solid object or liquid fall into the system, unplug the system and have it checked by qualified personnel before operating it any further.
- The AC power cord must be changed only at the qualified service shop.
- When you connect the AC power cord to the wall outlet (mains), even though the power is off, the system begins charging for remote and timer functions. Therefore the surface of this unit becomes warm, this is normal.

On placement

- Make sure the system fan is on during use. Place the system in a location with adequate air circulation, and do not place anything on the system.
- Place the system in a location with adequate ventilation to prevent heat build up.
- Do not place the system in an inclined position.
- Do not place the system in locations where it is;
 - Extremely hot or cold
 - Dusty or dirty
 - Very humid
 - Subject to vibrations
 - Subject to direct sunlight.

On installing

When you move the system, remove the CD.

continued

Precautions (continued)

On operation

If the system is brought directly from a cold to a warm location, or is placed in a very damp room, moisture may condense on the lens inside the CD player. Should this occur, the system will not operate properly. Remove the CD and leave the system turned on for about 2 hours until the moisture evaporates.

If you have any questions or problems concerning your system, please consult your nearest Sony dealer.

On the speaker system

This speaker system is magnetically shielded and can be used near TV sets. However, the picture on certain TV sets may become magnetically distorted. In such a case, turn off the power of the TV set once, and after 15 to 30 minutes turn it on again.

If there seems to be no improvement, locate the speaker system further away from the TV set. Also, be sure not to place objects in which magnets are attached or used near the TV set, such as audio racks, TV stands and toys. These may cause magnetic distortion to the picture due to their interaction with the system.

Notes on CDs

- Do not use a CD with tape, stickers, or paste on it as this may damage the player.
- Before playing, clean the CD with a cleaning cloth. Wipe the CD from the center out. Do not use solvents such as benzine, thinner, commercially available cleaners, or antistatic spray intended for vinyl LPs.
- Do not expose the CD to direct sunlight or heat sources such as hot air ducts, nor leave it in a car parked in direct sunlight.

Cleaning the cabinet

Use a soft cloth slightly moistened with mild detergent solution.

Troubleshooting

If you have any problem using this system, use the following checklist.

First, check that the AC power cord is connected firmly and that the speakers are connected correctly and firmly.

Should any problem persist, consult your nearest Sony dealer.

General

There is no sound.

- Press VOL +.
- Make sure the headphones are not connected.
- Check the speaker connections.

There is severe hum or noise.

- A TV or VCR is placed too close to the system. Move the system away from the TV or VCR.

“0:00” (or “12:00AM”) flashes in the display.

- A power failure occurred. Set the clock and timer settings again.

The timer does not function.

- Set the clock correctly.

The remote does not function.

- There is an obstacle between the remote and the system.
 - The remote is not pointing in the direction of the system's sensor.
 - The batteries have run down. Replace the batteries.
 - Do not place the system in locations where it is near an electric inverter system.
-

CD Player

The CD cannot be read.

- The CD was not placed in the disc tray properly. Place a CD vertically in the tray.

The CD will not eject.

- The CD has tape, stickers, or paste on it.

The CD will not play.

- The CD is dirty. Clean the CD with a cleaning cloth.
- The face of the CD is scratched. Exchange the CD.
- The CD is facing the wrong way.
- Moisture condensation has built up. Remove the CD and leave the system turned on for about 2 hours until the moisture evaporates.

Play does not start from the first track.

- The player is in program or shuffle mode. Press CD PLAY MODE repeatedly until "SHUF" and "PGM" disappear.

"- OVER -" is displayed.

- By pressing ►►, the last track on the disc has been exceeded. Press and hold (or press repeatedly) ◀◀ or ◀◀ to return to a track where playback can begin.

Tuner

Severe hum or noise ("TUNED" or "STEREO" flashes in the display).

- Remove the FM antenna from the rear panel and place the antenna outside the cabinet. Adjust the antenna.
- The signal strength is too weak. Connect an external antenna.
- Make sure the antenna is connected properly.
- The AM antenna wire is detached from the stand.

A stereo FM program is not received in stereo.

- Press STEREO/MONO so "STEREO" appears.

If other problems not described above occur, reset the system as follows:

- 1 Unplug the AC power cord.
- 2 Hold down I/⏻ then plug the AC power cord into the wall outlet again.

The system is reset to the factory settings. All the settings you made, such as the preset stations, clock, and timer are cleared. You should set them again.

Specifications

Amplifier section

For the U.S. model

AUDIO POWER SPECIFICATIONS

POWER OUTPUT AND TOTAL HARMONIC DISTORTION:

With 4 ohm loads both channels driven, from 70 – 20,000 Hz; rated 10 watts per channel minimum RMS power, with no more than 0.9% total harmonic distortion from 250 milliwatts to rated output.

Canadian model:

Continuous RMS power output (Reference)
15 + 15 watts
(4 ohms at 1 kHz, 10% THD)

European model:

DIN power output (Rated)
12 + 12 watts
(4 ohms at 1 kHz, DIN)

Continuous RMS power output (Reference)
15 + 15 watts
(4 ohms at 1 kHz, 10% THD)

Music power output (Reference)
15 + 15 watts

Other models:

DIN power output (Rated)
12 + 12 watts
(4 ohms at 1 kHz, DIN, 240 V)
12 + 12 watts
(4 ohms at 1 kHz, DIN, 220 V)

Continuous RMS power output (Reference)
15 + 15 watts
(4 ohms at 1 kHz, 10% THD, 240 V)
15 + 15 watts
(4 ohms at 1 kHz, 10% THD, 220 V)

Inputs
TAPE IN: voltage 250 mV,
impedance 47 kilohms

Outputs
TAPE OUT: voltage 250 mV,
impedance 1 kilohms
CD OUT: Optical
PHONES (stereo mini jack):
accepts headphones of 8 ohms or
more

CD player section

System	Compact disc and digital audio system
Laser	Semiconductor laser ($\lambda=780$ nm) Emission duration: continuous
Laser output	Max. 44.6 μ W* * This output is the value measured at a distance of 200 mm from the objective lens surface on the Optical Pick-up Block with 7 mm aperture.
Frequency response	20 Hz – 20,000 Hz

Tuner section

FM stereo, FM/AM superheterodyne tuner

FM tuner section

Tuning range	
North American model:	87.5 – 108.0 MHz (100 kHz step)
Other models:	87.5 – 108.0 MHz (50 kHz step)
Antenna	FM wire antenna
Antenna terminals	75 ohms unbalanced
Intermediate frequency	10.7 MHz

AM tuner section

Tuning range	
North American model:	531 – 1,710 kHz (with the interval set at 9 kHz) 530 – 1,710 kHz (with the interval set at 10 kHz)
European model:	531 – 1,602 kHz (with the interval set at 9 kHz)
Other models:	531 – 1,602 kHz (with the interval set at 9 kHz) 530 – 1,710 kHz (with the interval set at 10 kHz)
Antenna	AM loop antenna External antenna terminals
Intermediate frequency	450 kHz

Speaker

Speaker system	2-way, bass-reflex type
Speaker units	Woofer: 9 cm (3 ⁵ / ₈ in) dia., cone type Tweeter: 2 cm (1 ³ / ₁₆ in) dia., balanced drive
Impedance	4 ohms
Dimensions	130 × 216 × 183 mm (5 ¹ / ₈ × 8 ⁵ / ₈ × 7 ¹ / ₄ in) (w/h/d, incl. projecting parts and controls)
Mass	Approx 1.8 kg (3 lb 15 oz.) net per speaker

General

Power requirements	
North American model:	120 V AC, 60 Hz
European model:	230 V AC, 50/60 Hz
Other models:	110 – 240 V AC, 50/60 Hz
Power consumption	40 W
Dimensions	170 × 217 × 200 mm (6 ³ / ₄ × 8 ⁵ / ₈ × 7 ⁷ / ₈ in) (w/h/d, incl. projecting parts and controls)
Mass	Approx. 3.0 kg (6 lb 10 oz.)
Supplied accessories	Remote commander (1) Batteries (2) AM loop antenna (1) FM wire antenna (1) Speaker cords (2) Speaker legs (4)

Designs and specifications are subject to change without notice.

Index

A

- Adjusting
 - the sound 16
 - the volume 10, 11
- Antennas 5, 22
- Automatic Source Selection 10, 11
- Automatic Tuning 7, 11

B

- Batteries 5

C

- CD player 9, 12
- Clock setting 6
- Connecting. *See Hooking up*

D, E, F, G

- Daily Timer 18
- Display 6, 15
- DSG (Dynamic Sound Generator) 16

H, I, J, K

- Hooking up
 - optional components 20
 - the antennas 5, 22
 - the speaker 4

L

- Listening to
 - the radio 10
 - the sound of connected components 21

M

- Manual Tuning 7, 11

N

- Normal Play 9

O

- One Touch Play 10, 11

P, Q

- Playing
 - a CD 9
 - tracks in random order (Shuffle Play) 12
 - tracks in the desired order (Program Play) 13
 - tracks repeatedly (Repeat Play) 14
- Power Saving Mode 8
- Precautions 23
- Presetting radio stations 7
- Program Play 13

R

- Radio stations
 - presetting 7
 - tuning in 10
- RDS 17
- Recording a CD 22
- Repeat Play 14
- Resetting the system 25

S

- Setting the time 6
- Shuffle Play 12
- Sleep Timer 17
- Speakers 4
- Surround effect 16

T, U, V, W, X, Y, Z

- Timer
 - falling asleep to music 17
 - waking up to music 18
- Troubleshooting 24
- Tuner 7, 10
- Tuning interval 8