

Trinitron Color TV

Operating Instructions _____ **GB**

- Before operating the unit, please read this manual thoroughly and retain it for future reference.

_____ **CT**

_____ **CS**

KV-XF21M80

WARNING

- Dangerously high voltages are present inside the TV.
- Operate the TV only between 110 – 240 V AC.

 <p>Do not open the cabinet or the rear cover of the TV. Refer servicing to qualified personnel.</p>	 <p>Install the TV in a stable position. Do not allow children to climb onto it.</p>
 <p>To prevent fire or shock hazard, do not expose the TV to rain or moisture.</p>	 <p>Do not operate the TV if any liquid or solid object falls into it. Have it checked immediately by qualified personnel only.</p>
 <p>Do not install the TV in a confined space, such as a bookcase or built-in cabinet. Do not block the ventilation openings of the TV.</p>	 <p>Clean the TV with a dry soft cloth. Do not use benzine, thinner, or any other chemicals to clean the TV. Do not scratch the picture tube.</p>
 <p>Do not pull the power cord to disconnect the TV. Pull it out by the plug.</p>	 <p>Do not plug too many appliances into the same power socket. Do not damage the power cord.</p>
 <p>Disconnect the power cord during lightning storms or if you are not going to use the TV for several days.</p>	 <p>Do not install the TV in hot, humid or excessively dusty places.</p>

Table of Contents

WARNING

Using Your New TV

Getting Started	4
Step 1: Connect the antenna	4
Step 2: Insert the batteries into the remote	5
Step 3: Preset the channels automatically	5
Connecting optional components	6
Securing the TV	7
Presetting channels	8
Watching the TV	11

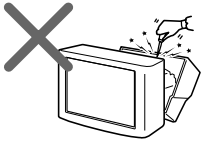
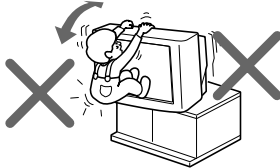
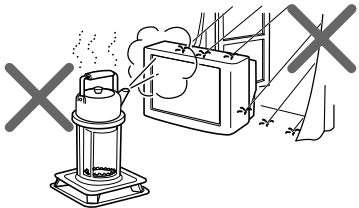
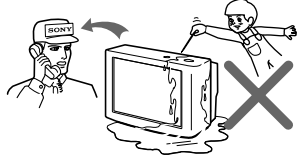
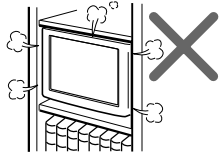
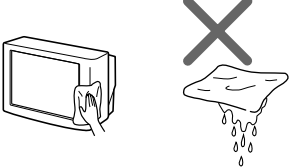
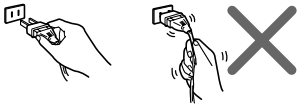
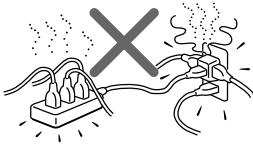
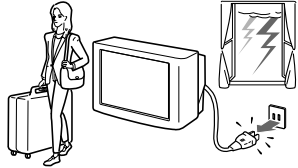
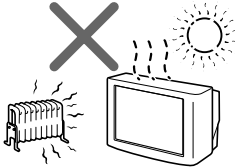
Advanced Operations

Customizing the picture and sound	14
Viewing your favorite channels — FAVORITE CHANNEL	16
Blocking the channels — CHILD LOCK	18

Additional Information

Troubleshooting	19
Self-diagnosis function	22
Identifying parts and controls	23
Specifications	Back cover

The features you will enjoy include:

- FAVORITE CH for quick and easy channel selection (page 16)
- PICTURE MODE/SOUND MODE/SURROUND for customizing your TV (pages 14, 15)

Your TV also offers the following setup features:

- On-screen display language options — English/Chinese (page 12)
- CHILD LOCK for preventing children from watching certain programs (page 18)
- INTELLIGENT VOL for automatic volume adjustment (page 12)
- PIC ROTATION for picture position adjustment (page 12)

Getting Started

Step 1

Connect the antenna

If you wish to connect a VCR, see the “Connecting a VCR” diagram below.

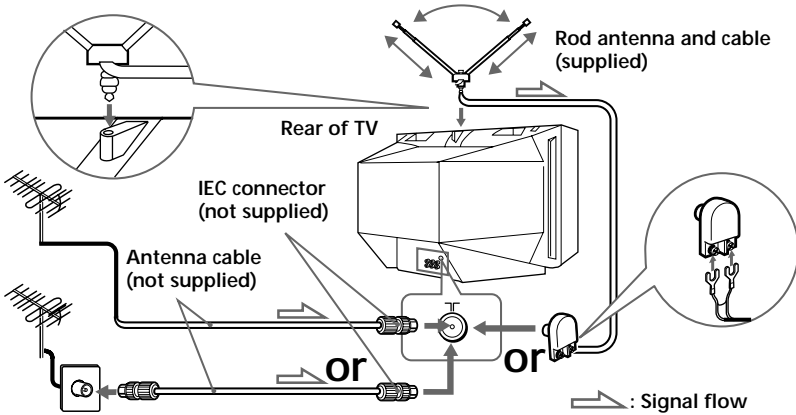

Note



- You are advised to use an outdoor antenna for better reception.

Connecting a VCR

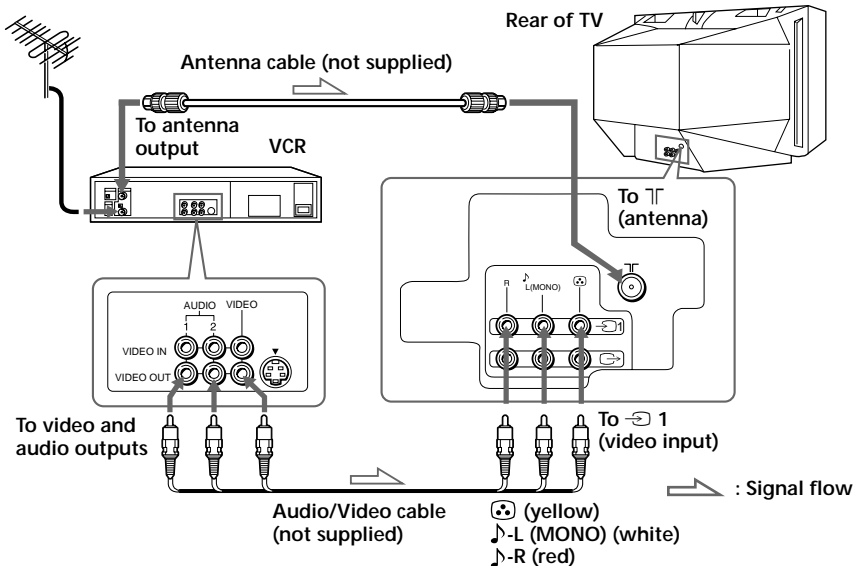
To play a video tape, press (see page 12).



Notes

- If you connect a monaural VCR, connect the yellow plug to  (the yellow jack) and the black plug to  (MONO) (the white jack).
- If you connect a VCR to the Υ (antenna) terminal, preset the signal output from the VCR to the program number 0 on the TV.
- When no signal is input to the connected video equipment, the TV screen becomes blue.

CAUTION

Do not connect the power cord until all other connections are complete; otherwise, a minimal current leakage through the antenna and/or other terminals to the ground could occur.

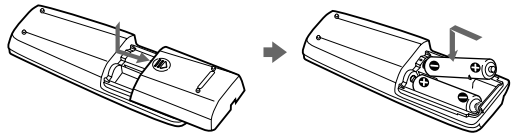
Step 2**Insert the batteries into the remote****Note**

- Do not use old batteries or different types of batteries together.

Step 3**Preset the channels automatically**

Front of TV

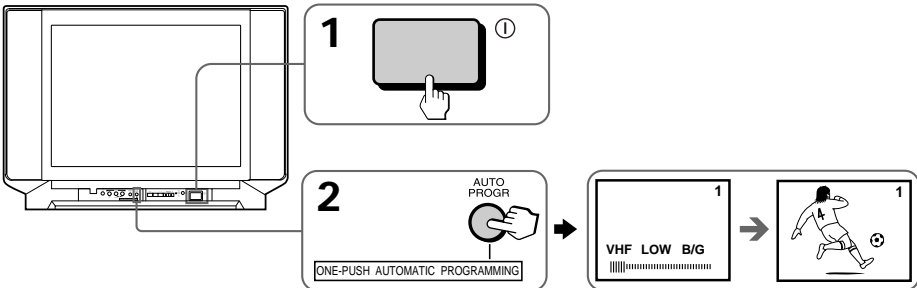
**Tips**

- If you want to stop automatic channel presetting, press SELECT twice.
- If an unwanted channel has been preset or you cannot preset a particular channel, preset your TV manually (see page 9).

Note

- During automatic channel presetting, the TV screen displays either B/G, I, D/K, or, M for the TV system (see page 8).

Now You Are Ready . . .

To watch the TV, see page 11.

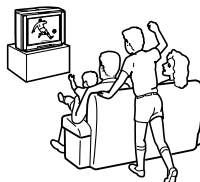

Connecting optional components

You can connect optional audio/video components, such as a VCR, multi disc player, camcorder, video game or stereo system.

To watch the picture of the connected equipment, press \rightarrow \oplus (see page 12).

Connecting a camcorder/video game equipment using the \rightarrow 2 (video input) jacks

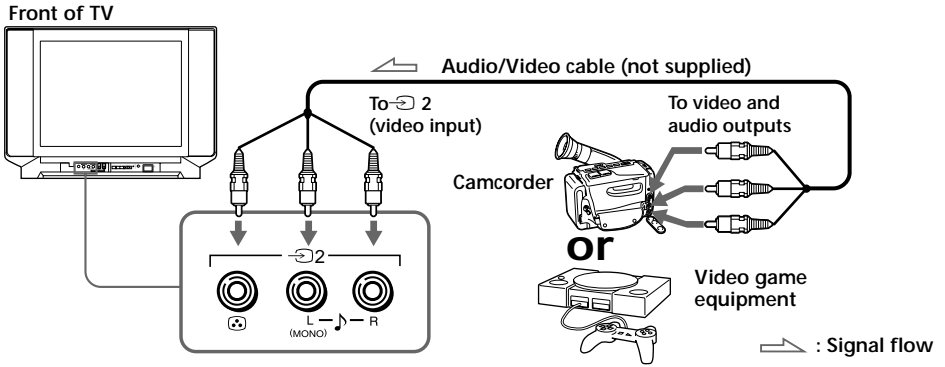

Note

- You can also connect video equipment to the \rightarrow 1 (video input) jacks at the rear of your TV.

Connecting audio/video equipment using the \rightarrow (monitor output) jacks

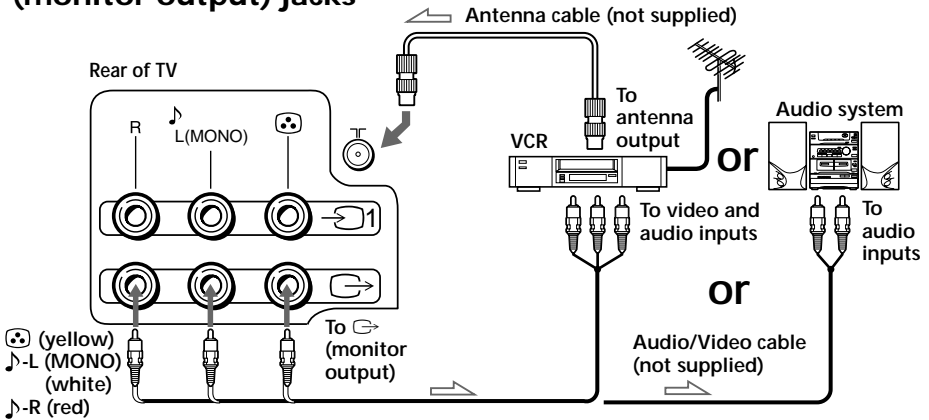

Note

- When connecting a monaural VCR, connect the yellow plug to \oplus (the yellow jack) and the black plug to $\♪$ -L (MONO) (the white jack).

Securing the TV

To prevent the TV from falling, secure the TV using one of the following methods:

- A** With the supplied screws, attach the stabilizer band to the TV stand and to the rear of the TV using the provided hole.

or

- B** Pass a cord or chain through the clamps to secure them to the rear of the TV and a wall or pillar.

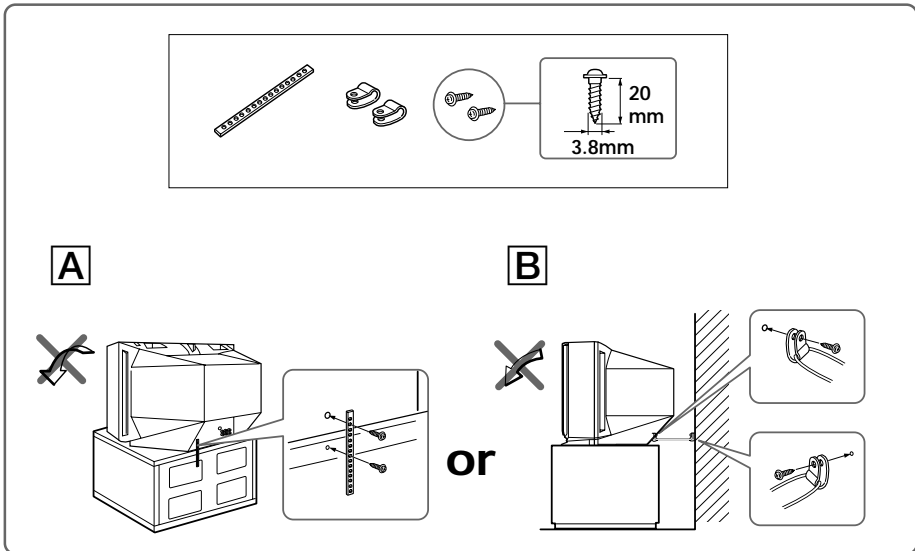

Note

- Use only the supplied screws. Use of other screws may damage the TV.

Presetting channels

You can preset up to 100 TV channels in numerical sequence from program number 1 using the remote and the buttons on your TV as well.

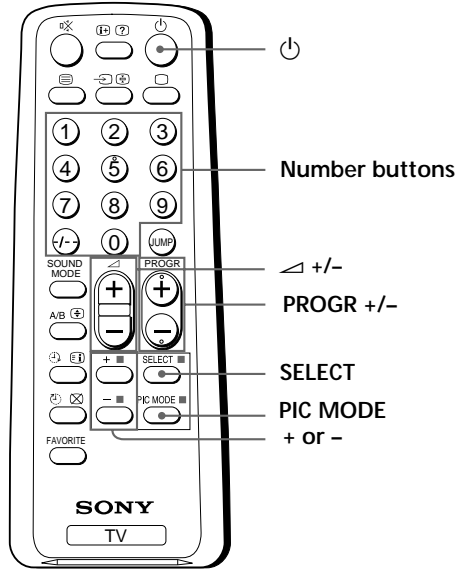
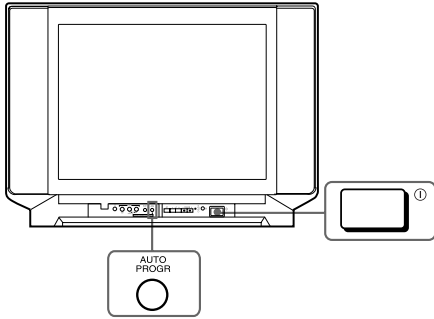

Presetting channels automatically

1 Press ① to turn on the TV.

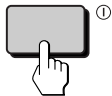

2 Press AUTO PROGR.

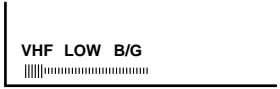

Note

- During automatic channel presetting, the TV screen displays either B/G, I, D/K, or M for the TV system.

To preset channels automatically from a specified program number

- (1) Press SELECT until "AUTO PROGRAM" appears.
- (2) Press + or -. The on-screen display will start flashing.
- (3) Press PROGR +/- or the number buttons until the desired program number appears.
- (4) Press + or -.

Presetting channels manually

- 1** Press SELECT until "MANUAL PROGRAM" appears.



- 2** Press + or -.



- 3** Press PROGR +/- or the number buttons until the desired program number appears.

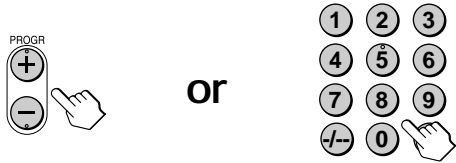

- 4** Press + or - until the desired channel picture appears.



- 5** Press SELECT.



To change the TV system setting

If the picture or sound is poor when receiving programs through the Υ (antenna) terminal, do the following.

- (1) Press SELECT until "TV SYS" appears.



- (2) Press + or - to select the appropriate TV system until the picture or sound quality is optimal.

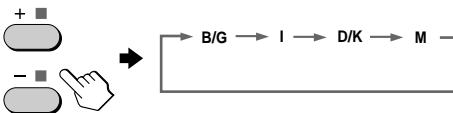

continued

Presetting channels (continued)

To change the color system setting

If the color is abnormal when receiving programs through the ㄗ (antenna) terminal or the ㊄ (video input) jack, do the following.

-
- 1** Press SELECT until “COL SYS” appears.



-
- 2** Press + or – to select the appropriate color system until the color is optimal.

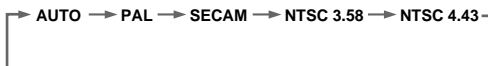

Tip

- Normally, set “COL SYS” to “AUTO.”

Skipping program numbers

-
- 1** Press PROGR +/- or the number buttons until the unused or unwanted program number appears.
-
- 2** Press SELECT until “MANUAL PROGRAM” appears.
-
- 3** Press + or –.
-
- 4** Press PIC MODE.
-
- 5** Press SELECT.
-

To preset the skipped program number again

Preset the channel automatically or manually.

Tip

- You can also use SELECT and ㄗ +/- on the TV to preset channels and skip program numbers.

To use the fine tuning (FINE) function

The fine tuning (FINE) function may help reduce double images and lines moving across the TV screen.

- (1) Select the program number you want to adjust.
- (2) Press SELECT until “MANUAL PROGRAM” appears on the screen.
- (3) Press + or – on the remote control once.
- (4) Press ㄗ ㄗ to display “FINE” on the screen.
- (5) Press + or – continuously until the picture quality is optimal.
The + or – icon on the screen flashes while tuning.
- (6) Press SELECT to return to normal screen.

Watching the TV

This section explains functions used while watching the TV. Most operations can be done using the remote.

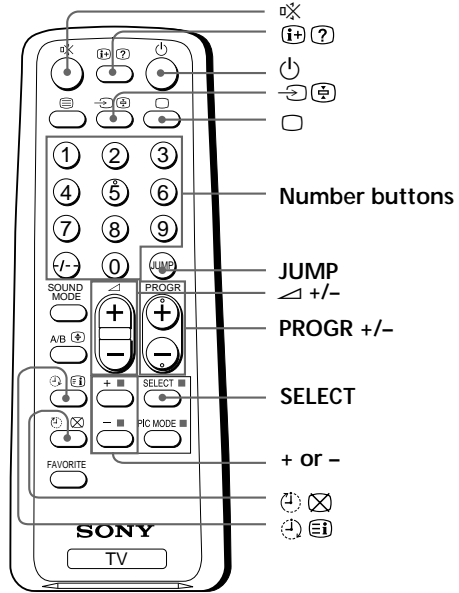
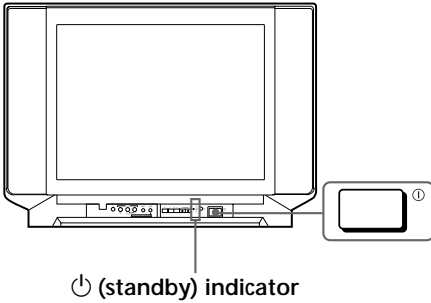

1 Press ① to turn on the TV.

When the TV is in the standby mode (the ⏻ indicator on the TV is lit red), press ⏻ on the remote.

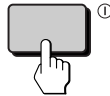

2 Press PROGR +/- or the number buttons to select the TV program.

For double digit numbers, press -/-, then the number (e.g., for 25, press -/-, then 2 and 5).

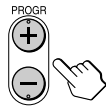

or

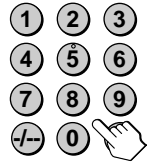

3 Press ◀ +/- to adjust the volume.



continued

Watching the TV (continued)

Additional tasks

To	Press
Turn off temporarily	. The indicator on the TV lights up red.
Turn off completely	on the TV.
Mute the sound	.
Watch the video input (VCR, camcorder, etc.)	to select "VIDEO 1" or "VIDEO 2." To return to the TV program, press .
Jump back to the previous channel	JUMP.
Display the on-screen information*	.
Adjust the volume of each TV program automatically	SELECT repeatedly until "INTELLIGENT VOL" appears, then press + or - to select "ON." To cancel, select "OFF."
Adjust the picture position when it is not aligned to the TV screen	SELECT repeatedly until "PIC ROTATION" appears, then press + or - to adjust the alignment of the picture position. The or icon on the screen flashes while adjusting.

* The picture, sound, and either the program number or video mode are displayed. The on-screen display for the picture and sound information disappears after about 3 seconds.

Changing the on-screen display language

- 1 Press SELECT until "LANGUAGE / 语言: ENGLISH" appears on the screen.



- 2 Press + or - to select "中文".



Tip

- You can also use SELECT and +/- on the TV to select the on-screen display language.

Setting the Wake Up timer

- 1** Press  until the desired period of time appears.

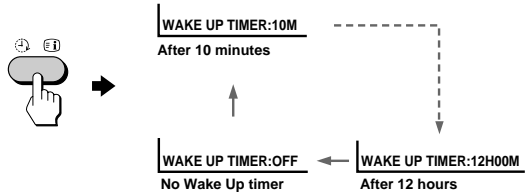

- 2** Select the TV program or video mode you want to wake up to.

- 3** Press  or set the Sleep timer if you want the TV to turn off automatically.

The  indicator on the TV lights up orange.

To cancel the Wake Up timer

Press  until “WAKE UP TIMER: OFF” appears, or turn off the TV’s main power.

Notes

- The Wake Up timer starts immediately after the on-screen display disappears.
- If no buttons or controls are pressed for more than two hours after the TV is turned on using the Wake Up timer, the TV automatically goes into the standby mode. To resume watching the TV, press any button or control on the TV or the remote.

Setting the Sleep timer

Press  until the desired period of time appears.

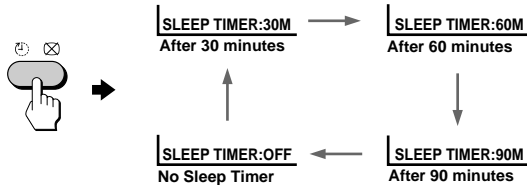

To cancel the Sleep timer

Press  until “SLEEP TIMER: OFF” appears, or turn the TV off.

Customizing the picture and sound

You can customize the picture and sound by selecting the picture and sound modes or by adjusting its settings.

You can change the sound effect by selecting the surround mode.

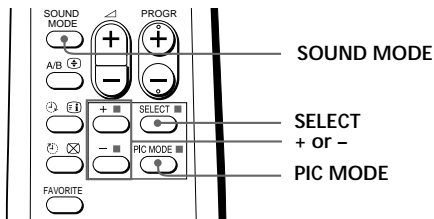

Selecting the picture mode

Press PIC MODE repeatedly until you get the desired picture mode.

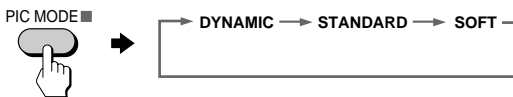

Select	To
DYNAMIC	receive high contrast pictures.
STANDARD	receive normal contrast pictures.
SOFT	receive mild contrast pictures.

Selecting the sound mode

Press SOUND MODE repeatedly until you get the desired sound mode.



Select	To
DYNAMIC	listen to dynamic and clear sound that emphasizes the low and high sound.
DRAMA	listen to sound that emphasizes voice and background music.
SOFT	receive soft sound.

Adjusting the picture and sound settings

- 1 Press SELECT until the desired setting appears.



Each time you press SELECT, the setting items change as follows:

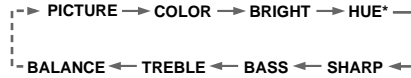

- 2 Press + or – to adjust the item.

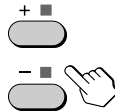

- 3 To adjust other items, repeat steps 1 and 2.

* "HUE" can be adjusted for the NTSC systems only.

Note

- When you select a picture or sound mode, the adjusted settings will be reset according to the selected mode.

Tip

- You can also use SELECT and \triangle +/- on the TV to adjust the picture and sound settings.

Selecting the surround mode

- 1 Press SELECT repeatedly until "SURROUND" appears.

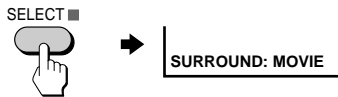

- 2 Press + or – to select the desired surround sound.

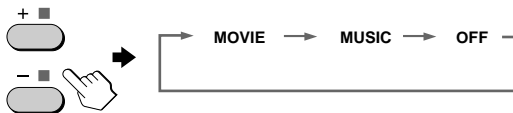

Select	To
MOVIE	listen to sound that spreads out over a large area, giving the feeling of being at a movie theatre.
MUSIC	listen to the sound that gives the feeling of being at a live concert.
OFF	turn off the surround sound.

Viewing your favorite channels

— FAVORITE CHANNEL

You can display six of your favorite channels for quick and easy selection. You can change the favorite channel setting as well.

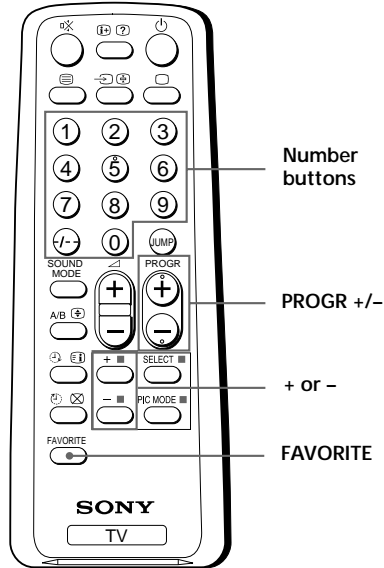

Selecting a favorite channel

- 1 Press FAVORITE.

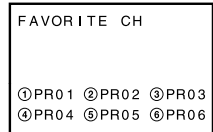

- 2 Press one of the number buttons to select the desired channel.

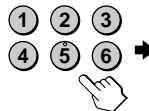

When you use the FAVORITE CH feature for the first time, six preset channels will appear.

Changing the favorite channel setting

- 1** Press SELECT until "FAVORITE CH SET UP" appears.

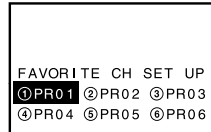
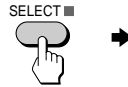

- 2** Press + or - to select the favorite channel you want to change (e.g., ③ PR03).

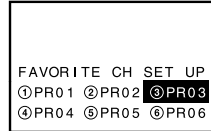
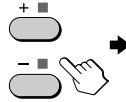

- 3** Press PROGR +/-, or number buttons to change the program number.

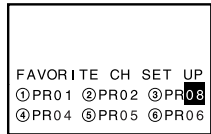
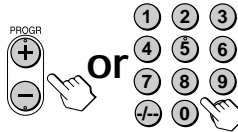

- 4** Repeat steps 2 and 3 to set other favorite channels.

- 5** Press SELECT.

Blocking the channels

— CHILD LOCK

You can prevent children from watching certain programs by using the buttons on the remote control.

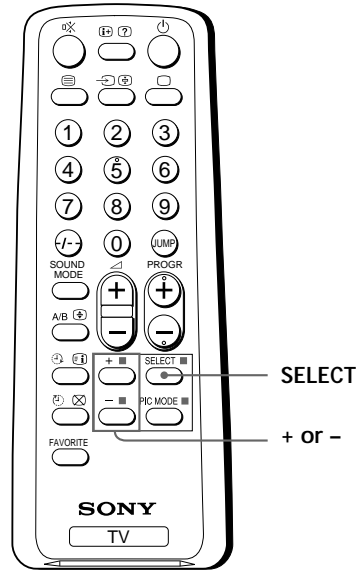

1 Select the TV program you want to lock.

2 Press SELECT until "CHILD LOCK" appears on the screen.



3 Press + or - to select "ON".

The  symbol appears on the screen.

To unlock the channel, press + or - to select "OFF."

The  symbol disappears from the screen.

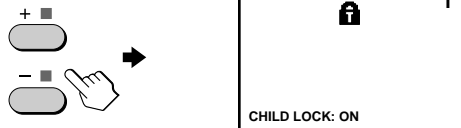







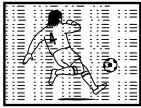

Note

- If you preset a locked channel, that particular channel will be unlocked.







Troubleshooting



If you have any problem while viewing your TV, please check the following troubleshooting guide. If the problem persists, contact your Sony dealer.

Symptom	Solutions	Possible cause
Snowy picture 	<ul style="list-style-type: none"> • Check the antenna cable and connection on the TV, VCR and at the wall. (page 4) • Press SELECT until “MANUAL PROGRAM” appears on the screen, then preset the channel again. (page 9) 	<ul style="list-style-type: none"> • The connection is loose or the cable is damaged. • The channel presetting is inappropriate or incomplete.
Noisy sound 	<ul style="list-style-type: none"> • Check the antenna type (VHF/UHF). Contact a Sony dealer for advice. • Adjust the antenna direction. Contact a Sony dealer for advice. • Try using a booster. 	<ul style="list-style-type: none"> • The antenna type is inappropriate. • The antenna direction needs adjustment. • Signal transmission is low.
Distorted picture 	<ul style="list-style-type: none"> • Turn off or disconnect the booster if it is in use. 	<ul style="list-style-type: none"> • Broadcast signals are too strong.
Noisy sound 	<ul style="list-style-type: none"> • Turn off or disconnect the booster if it is in use. 	<ul style="list-style-type: none"> • Broadcast signals are too strong.
Good picture 	<ul style="list-style-type: none"> • If the sound of all the channels are noisy, check the TV system (TV SYS) setting (page 9), then press AUTO PROGR to preset the channels again (page 8). • If the sound of some channels are noisy, select the channel, then select the appropriate TV system (TV SYS) (page 9). 	<ul style="list-style-type: none"> • The TV system setting or channel presetting is inappropriate or incomplete.
Noisy sound 	<ul style="list-style-type: none"> • Turn off or disconnect the booster if it is in use. 	<ul style="list-style-type: none"> • Broadcast signals are too strong.
No picture 	<ul style="list-style-type: none"> • Check the power cord, antenna and the VCR connections. • Press ⏻ (power). • Press ⏻ (main power) on the TV to turn off the TV for about five seconds, then turn it on again. 	<ul style="list-style-type: none"> • The power cord, antenna or VCR is not connected. • The TV is not turned on.
No sound 	<ul style="list-style-type: none"> • Check the power cord, antenna and the VCR connections. • Press ⏻ (power). • Press ⏻ (main power) on the TV to turn off the TV for about five seconds, then turn it on again. 	<ul style="list-style-type: none"> • The power cord, antenna or VCR is not connected. • The TV is not turned on.

continued

Troubleshooting (continued)

Symptom	Solutions	Possible cause
<p>Good picture</p> 	<ul style="list-style-type: none"> • Press \triangle + to increase the volume level. • Press M to cancel the muting. 	<ul style="list-style-type: none"> • The volume level is too low. • The sound is muted.
<p>No sound</p> 		
<p>Dotted lines or stripes</p> 	<ul style="list-style-type: none"> • Do not use a hair dryer or other equipment near the TV. • Adjust the antenna direction for minimum interference. Contact a Sony dealer for advice. 	<ul style="list-style-type: none"> • There is local interference from cars, neon signs, hair dryers, power generators, etc.
<p>Double images or "ghosts"</p> 	<ul style="list-style-type: none"> • Use a highly directional antenna. • Use the fine tuning (FINE) function. (page 10) • Adjust the antenna direction. Contact a Sony dealer for advice. • Turn off or disconnect the booster if it is in use. 	<ul style="list-style-type: none"> • Broadcast signals are reflected by nearby mountains or buildings. • The antenna direction needs adjustment. • Use of a booster is inappropriate.
<p>No color</p> 	<ul style="list-style-type: none"> • Press SELECT until "COLOR" appears on the screen, then press + or - to adjust the color level. (page 15) • Press SELECT until "COL SYS" appears on the screen, then check the color system setting (usually set this to "AUTO"). (page 10). • Adjust the antenna direction. Contact a Sony dealer for advice. 	<ul style="list-style-type: none"> • The color level setting is too low. • The color system setting is inappropriate. • The antenna direction needs adjustment.
<p>Abnormal color patches</p> 	<ul style="list-style-type: none"> • Keep external speakers or other electrical equipment away from the TV. Do not move the TV while the TV is turned on. Press O (main power) on the TV to turn off the TV for about five minutes, then turn it on again. 	<ul style="list-style-type: none"> • There are magnetic effects from external speakers or other electrical equipment that may affect the TV. • The direction of the earth's magnetic field may affect the TV.

Symptom	Solutions	Possible cause
Picture slant 	<ul style="list-style-type: none"> • Press SELECT until “PIC ROTATION” appears on the screen, then press + or – to align the picture to the TV screen. (page 12) 	<ul style="list-style-type: none"> • The terrestrial magnetism affects your TV set.
Lines moving across the TV screen.	<ul style="list-style-type: none"> • Use the fine tuning (FINE) function. (page 10) 	<ul style="list-style-type: none"> • There is interference from external sources, e.g., heavy machinery, or a nearby broadcast station.
The  indicator on your TV flashes red once or more in intervals of 3 seconds.	<ul style="list-style-type: none"> • Contact your nearest Sony service center. (page 22) 	<ul style="list-style-type: none"> • Your TV may need service.
TV cabinet creaks.	—	<ul style="list-style-type: none"> • Changes in room temperature sometimes make the TV cabinet expand or contract, causing a noise. This does not indicate a malfunction.
A small “boom” sound is heard when the TV is turned on.	—	<ul style="list-style-type: none"> • The TV’s demagnetizing function is working. This does not indicate a malfunction.

Self-diagnosis function

Your TV is equipped with a self-diagnosis function. If there is a problem with your TV, the ⏻ (standby) indicator flashes red. The number of times the ⏻ indicator flashes indicates the possible causes.

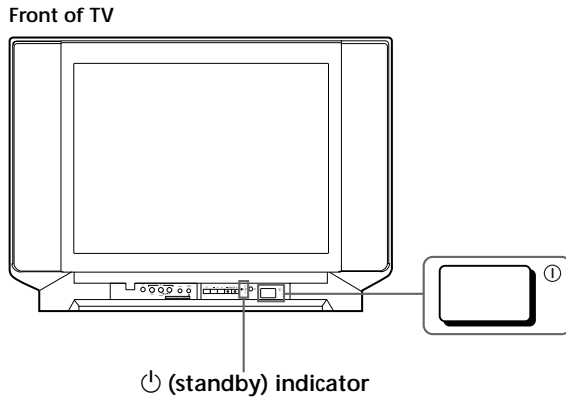

-
- 1** Check that the ⏻ indicator flashes red once or more in intervals of 3 seconds.
-
- 2** Count the number of times the ⏻ indicator flashes.
-
- 3** Press ① (main power) to turn off your TV.
-
- 4** Inform your nearest Sony service center about the number of times the ⏻ indicator flashes.
Be sure to note the model name and serial number located on the rear of your TV.
-

Identifying parts and controls

Refer to the pages indicated in parentheses () for details.

Front panel

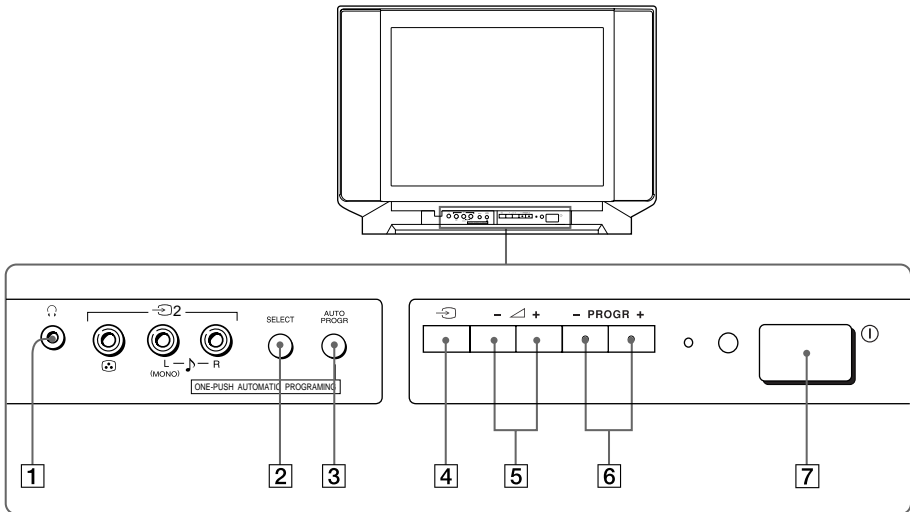

- 1 (headphones) jack
- 2 SELECT button (10)
- 3 AUTO PROGR (program) button (5)
- 4 (TV/video) button (12)
- 5 +/- (volume) buttons (10)
- 6 PROGR +/- (program) buttons (11)
- 7 (main power) button (11)

continued

Identifying parts and controls (continued)

Remote Control

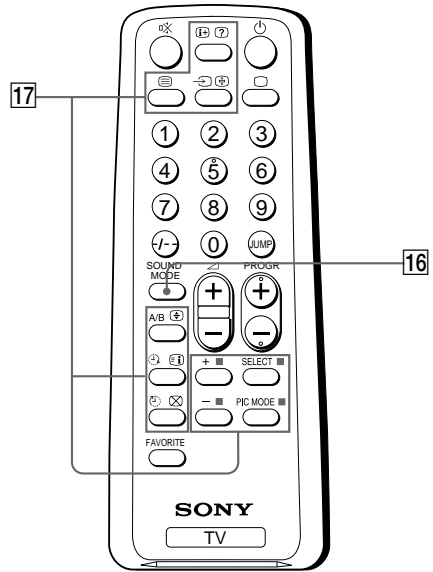
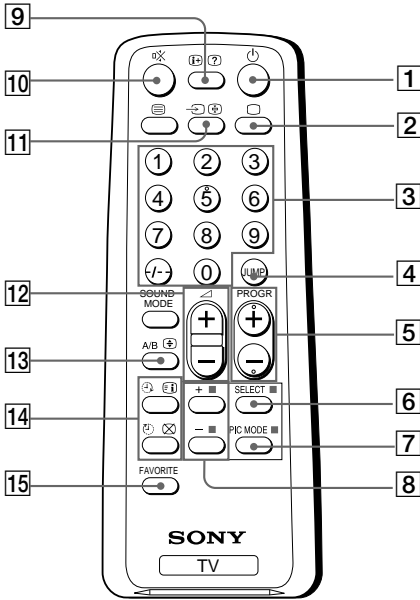

- 1** ⏻ (power) button (11)
- 2** 📺 (TV) button (12)
- 3** Number buttons (9)
- 4** JUMP button (12)
- 5** PROGR +/- buttons (8)
- 6** SELECT button (8)
- 7** PIC MODE button (14)
- 8** +/- buttons (8)
- 9** 📺 (display) button (12)
- 10** 📴 (muting) button (12)
- 11** 📺 (video) button (12)
- 12** 🔊 +/- (volume) buttons (11)
- 13** A/B buttons
Not available on this model.
- 14** Timer setting buttons (13)
 - 🕒 (wake up timer)
 - 🕒 (sleep timer)
- 15** FAVORITE button (16)

- 16** SOUND MODE button (14)
- 17** Teletext operation buttons
Not available on this model.
 - 📄 (text) 🔍 (enlarge)
 - 📄 (reveal) ⏸ (hold)
 - 📄 (index) ✖ (text clear)
 - (FASTEXT: red, green, yellow, blue)

Names/symbols of buttons on the remote are indicated in different colors to represent the available functions.

Label color	Button function
White	For general TV operations
Green	For Teletext operations

Specifications

	KV-XF21M80	Note
Power requirements	110-240 V AC, 50/60 Hz	
Power consumption (W)	Indicated on the rear of the TV	
Television system	B/G, I, D/K, M	
Color system	PAL, PAL 60, SECAM, NTSC4.43, NTSC3.58	
Channel coverage B/G	VHF : E2 to E12 UHF : E21 to E69 CATV : S01 to S03, S1 to S41	
I	UHF : B21 to B68 CATV : S01 to S03, S1 to S41	
D/K	VHF : C1 to C12, R1 to R12 UHF : C13 to C57, R21 to R60 CATV : S01 to S03, S1 to S41, Z1 to Z39	
M	VHF : A2 to A13 UHF : A14 to A79 CATV : A-8 to A-2, A to W+4, W+6 to W+84	
⌚ (Antenna)	75-ohm external terminal	
Audio output	5W + 5W	
Number of terminal 📺 (Video)	Input: 2 Output: 1 Phono jacks; 1 Vp-p, 75 ohms	
🎵 (Audio)	Input: 2 Output: 1 Phono jacks; 500 mVrms	
🎧 (Headphones)	Output: 1 Minijack	
Picture tube	21in	
Tube size (cm)	54	Measured diagonally
Screen size (cm)	51	Measured diagonally
Dimensions (w/h/d, mm)	640 × 456 × 498	
Mass (kg)	27	

Design and specifications are subject to change without notice.

Sony  line

<http://www.world.sony.com/>

Printed on recycled paper

Sony Corporation Tokyo, Japan