

# ***VIDEO CD Player***

---

Operating Instructions



***MCE-S78K***

## WARNING

To prevent fire or shock hazard, do not expose the unit to rain or moisture.

To avoid electrical shock, do not open the cabinet. Refer servicing to qualified personnel only.

Laser component in this product is capable of emitting radiation exceeding the limit for Class 1.

CLASS 1 LASER PRODUCT  
LUOKAN 1 LASERLAITE  
KLASS 1 LASERAPPARAT

This appliance is classified as a CLASS 1 LASER product. The CLASS 1 LASER PRODUCT MARKING is located on the rear exterior.

## Precautions

### On safety

- Caution – The use of optical instruments with this product will increase eye hazard.
- Should any solid object or liquid fall into the cabinet, unplug the player and have it checked by qualified personnel before operating it any further.

### On power sources

- Before operating the player, check that the operating voltage of the player is identical with your local power supply. The operating voltage is indicated on the nameplate at the rear of the player.
- The unit is not disconnected from the AC power source (mains) as long as it is connected to the wall outlet, even if the unit itself has been turned off.
- If you are not going to use the player for a long time, be sure to disconnect the player from the wall outlet. To disconnect the AC power cord (mains lead), grasp the plug itself; never pull the cord.
- AC power cord must be changed only at the qualified service shop.

### On placement

- Place the player in a location with adequate ventilation to prevent heat build-up in the player.
- Do not place the player on a soft surface such as a rug that might block the ventilation holes on the bottom.
- Do not place the player in a location near heat sources, or in a place subject to direct sunlight, excessive dust or mechanical shock.

### On operation

- If the player is brought directly from a cold to a warm location, or is placed in a very damp room, moisture may condense on the lenses inside the player. Should this occur, the player may not operate properly. In this case, remove the disc and leave the player turned on for about an hour until the moisture evaporates.

### On adjusting volume

- Do not turn up the volume while listening to a portion with very low level inputs or no audio signals. If you do, the speakers may be damaged when a peak level portion is played.

### On cleaning

- Clean the cabinet, panel and controls with a soft cloth slightly moistened with a mild detergent solution. Do not use any type of abrasive pad, scouring powder or solvent such as alcohol or benzine.

If you have any questions or problems concerning your player, please consult your nearest Sony dealer.

## Welcome!

Thank you for purchasing the Sony Video Compact Disc (VIDEO CD) Player. Before operating the unit, please read this manual thoroughly and retain it for future reference.

## About This Manual

The instructions in this manual are for model MCE-S78K.

### Conventions

- Instructions in this manual describe the controls on the player.  
You can also use the controls on the remote if they have the same or similar names as those on the player.
- The following icons are used in this manual:



Indicates that you can use only the remote to do the task.



Indicates tips and hints for making the task easier.

# TABLE OF CONTENTS

---

<b>This Player Can Play the Following Discs</b> .....	4
---	---

---

<b>Getting Started</b>	
Unpacking .....	4
Hooking Up the System .....	5

---

<b>Basic Operations</b>	
<b>Playing a VIDEO CD</b> .....	8

---

<b>Enjoying Karaoke</b>	
Playing Karaoke .....	10

---

<b>Enjoying Playback Using the PBC Functions</b>	
Playing VIDEO CDs with PBC Functions (PBC Playback) .....	12
Locating Scenes Directly Using the Scene Numbers (Scene Search) .....	13

---

<b>Locating a Scene or Track You Want</b>	
Using the On-Screen Display .....	15
Using the Front Panel Display .....	16
Resuming Playback from the Point You Stopped a Disc (Resume Play) .....	17
Locating a Specific Track .....	18
Locating a Point by Elapsed Time (Time Search) .....	18
Locating a Particular Point in a Scene or Track .....	19
Locating by Observing Several Scenes at One Time (Digest Play) .....	20

---

<b>Playing CDs in Various Modes</b>	
Playing Repeatedly .....	22
Playing in Random Order (Shuffle Play) .....	23
Creating Your Own Program (Program Play) .....	23
Enjoying Picture Effects .....	25
Enjoying Sound Effects .....	25
Switching the Sound .....	26
Controlling the TV with the Supplied Remote .....	26

---

<b>Enjoying Karaoke with Non-Karaoke Discs</b>	
Playing Karaoke with Any Stereo Discs (Karaoke Pon) .....	27



---

<b>Additional Information</b>	
Notes on Discs .....	28
Troubleshooting .....	28
Specifications .....	29
Glossary .....	29

---

<b>Index</b> .....	30
--------------------	----

## This Player Can Play the Following Discs

	VIDEO CDs	Audio CDs
Disc logo		
Contents	Audio + Video (moving pictures)	Audio
Disc size	12 cm/8 cm	12 cm/8 cm (CD single)
Play time	74 min./20 min.	74 min./20 min.

To play VIDEO CDs, see page 8.

To enjoy PBC Playback of VIDEO CDs with PBC functions, see page 12.

### Note on VIDEO CDs

This player conforms to Ver. 1.1 and Ver. 2.0 of VIDEO CD standards. You can enjoy two kinds of playback according to the disc type.

Disc type	You can
VIDEO CDs without PBC functions (Ver. 1.1 discs)	Enjoy video playback (moving pictures) as well as music.
VIDEO CDs with PBC functions (Ver. 2.0 discs)	Play interactive software using menu screens displayed on the TV screen (PBC Playback), in addition to the video playback functions of Ver 1.1 discs. Moreover, you can play high-resolution still pictures, if they are included on the disc.

## Getting Started

### Unpacking



Check that you received the following items:

- Audio and video connecting cord (3 phono plugs – 3 phono plugs) (1)
- Remote commander (remote) RMT-F88V (1)
- Sony R6 (size AA) batteries (2)

### Inserting batteries into the remote

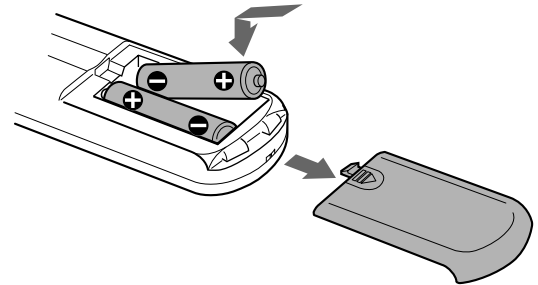
You can control the player using the supplied remote. Insert two R6 (size AA) batteries by matching the + and – on the batteries. When using the remote, point it at the remote sensor  on the player.



 You can control Sony TVs with the  mark using the supplied remote  
See page 26.

 **When to replace batteries**  
With normal use, the batteries should last for about six months. When the remote no longer operates the player, replace all the batteries with new ones.

### Notes

- Do not leave the remote near an extremely hot or humid place.
- Do not drop any foreign object into the remote casing, particularly when replacing the batteries.
- Do not expose the remote sensor to direct sunlight or lighting apparatuses. Doing so may cause a malfunction.
- If you don't use the remote for an extended period of time, remove the batteries to avoid possible damage from battery leakage and corrosion.

# Hooking Up the System

## Overview

This section describes how to hook up the VIDEO CD player to a TV (with audio/video input jacks) and/or an amplifier. Be sure to turn off the power of each component before making the connections.

### ■ When listening to the sound through TV speakers

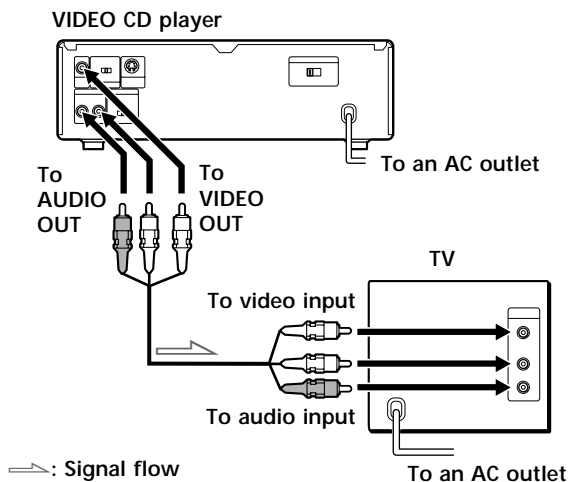

### ■ When listening to the sound through speakers connected to an amplifier

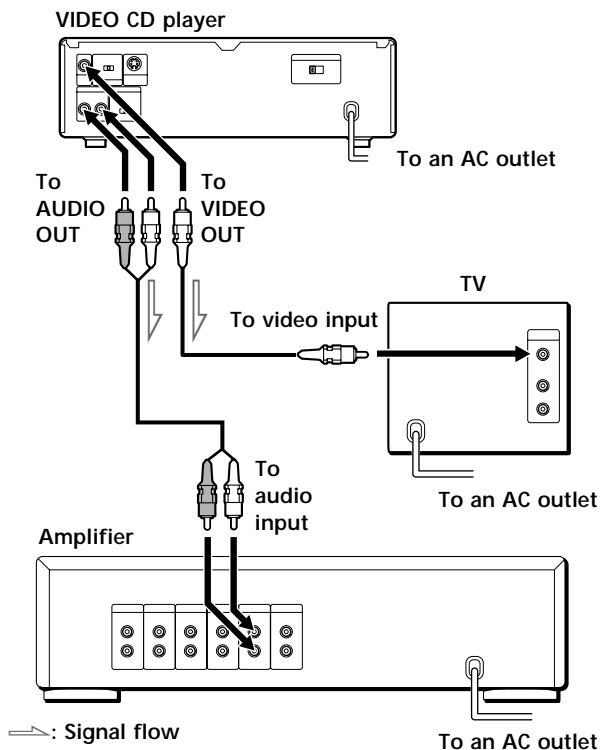

### What cords will I need?

Audio and video connecting cord (supplied) (1)

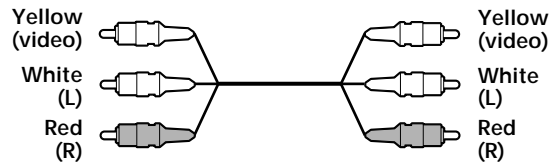

Video connecting cord (not supplied) (1)



Audio connecting cord (not supplied) (1)

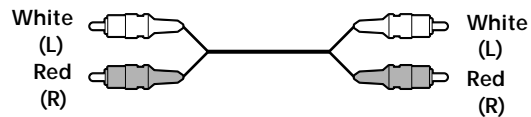

## Hookups

When connecting the cord, be sure to match the color-coded cord to the appropriate jacks on the components: Yellow (video) to Yellow, Red (right) to Red and White (left) to White. Be sure to make connections firmly to avoid hum and noise.

### ■ When listening to the sound through TV speakers

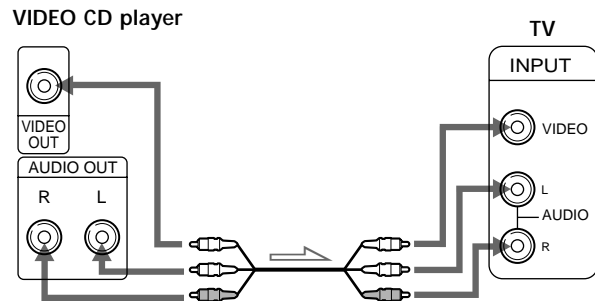

### ■ When listening to the sound through speakers connected to an amplifier

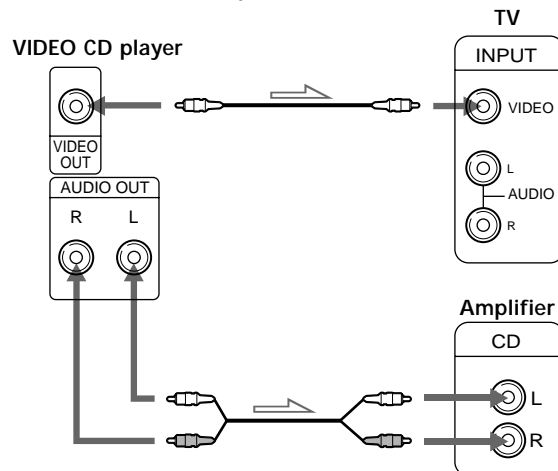

(Continued)

 If your TV or VCR has an S video input connector Connect the component via the S VIDEO OUT connector using the S video cable (not supplied). You will get a better picture.

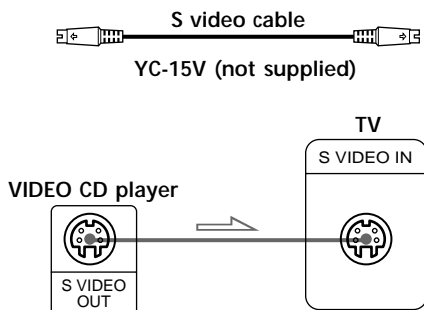

## Important

### Setting the color system switch

This player conforms to the NTSC and PAL color systems. Set the COLOR SYSTEM switch on the rear of the player to the appropriate position, according to your TV.

- If the color system of your TV is NTSC:  
Set the COLOR SYSTEM switch to NTSC. Pictures will not be displayed if you set the switch to PAL. When you play a VIDEO CD recorded in the PAL color system, the picture will be stretched vertically and will be displayed with the lower part of the picture cut off.
- If the color system of your TV is PAL:  
Set the COLOR SYSTEM switch to PAL. Pictures will not be displayed if you set the switch to NTSC. When you play a VIDEO CD recorded in the NTSC color system, the picture will be stretched horizontally and will be displayed with the lower part of the screen masked in black.
- If your TV automatically changes the color system according to the input signal:  
Pictures will be displayed with the switch set to either NTSC or PAL.  
If you set the COLOR SYSTEM switch to AUTO, the player automatically changes the color system of video output according to the color system of the VIDEO CD to be played. In this case, the color system selected remains until you unplug the player, or you play another VIDEO CD with a different color system. If you unplug the player, the color system will be set to PAL automatically when you turn on the player again.

Be sure to turn off and on the player when you change the setting.

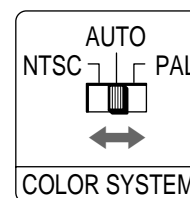

**Setting the VOLTAGE SELECTOR  
(only on a model supplied with a voltage selector)**

Check that the VOLTAGE SELECTOR on the rear panel of the player is set to the local power line voltage. If not, set the selector to the correct position using a screwdriver before connecting the AC power cord to a wall outlet.

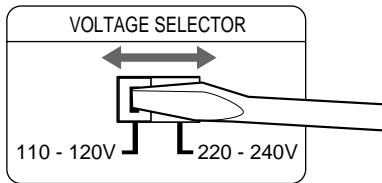

**Connecting the AC power cord**

Connect the AC power cord to a wall outlet.

# Playing a VIDEO CD

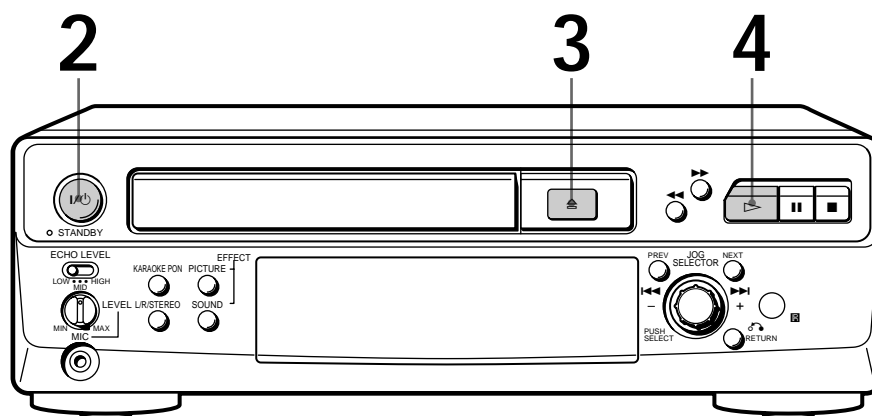

- See pages 5 – 7 for the hookup information.
- You can also play audio CDs just like VIDEO CDs.
- When you turn on the player, “SONY” logo appears on the TV screen. When you press any button, the logo disappears thereafter.

You can turn on or off the player using the remote. Press I/⏻ on the remote. You can also directly turn on the player by pressing the ⏻ or ▷ button on the player.

When playing VIDEO CDs with PBC functions  
In Step 4, the menu screen appears on the TV screen. You can play the VIDEO CD interactively, following the instructions on the menu screen. (PBC Playback, see page 12.)

What is a VIDEO CD with PBC functions?  
See page 12 or 29.

---

**1** When using a TV  
Turn on the TV and select the video input so that you can view the pictures from this player.

**When using an amplifier**  
Turn on the amplifier and select the CD player position so that you can listen to the sound from this player.

---

**2** Press I/⏻ to turn on the player.

---

**3** Press ⏻, and place the disc on the disc tray.

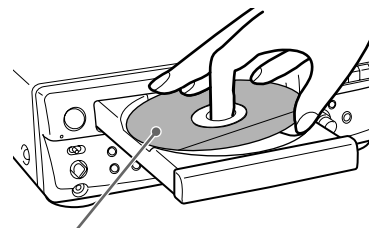

With the label side up

---

**4** Press ▷.  
The disc tray closes and the player plays all the tracks once (Continuous Play). Adjust the volume on the TV or the amplifier.

---





 When "RESUME" appears in the front panel display  
You can resume playback from the point you stopped the VIDEO CD (Resume Play, see page 17).

 The player enters standby mode automatically (Sleep function)  
When 20 minutes elapse after the player stops, it enters standby mode.

To stop playback

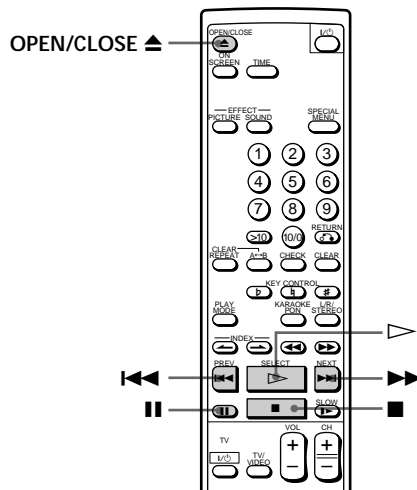
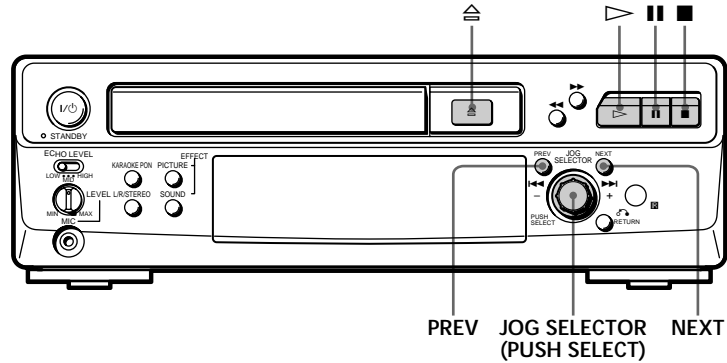
Press ■.



 What is a track?  
A disc is divided into sections of a picture or a music piece called "tracks." Each track is assigned with a track number to locate the track you want.

To	Press
Pause	■
Resume play after pause	■ or ▷
Select the track (in Continuous Play mode)	<p><b>While playing, on the player:</b></p> <ul style="list-style-type: none"> <li>• Turn JOG SELECTOR to select the track number</li> <li>• Press NEXT to go to the next scene or track</li> <li>• Press PREV to go back to the preceding scene or track</li> </ul> <p><b>While playing, on the remote:</b></p> <ul style="list-style-type: none"> <li>• Press ►► to go to the next scene or track</li> <li>• Press ◀◀ to go back to the preceding scene or track</li> </ul> <p><b>Before you start playing:</b> Turn JOG SELECTOR, or press NEXT, PREV, ◀◀ or ►► to select the track number, then press JOG SELECTOR or ▷</p>
Stop play and remove the CD	☰

## Playing Karaoke

You can play karaoke (singing along) with CDs. Be sure to set the on-screen display mode to ON SCREEN 1 or ON SCREEN 2 (see page 15). If you select ON SCREEN OFF display mode, no information is shown on the TV screen.

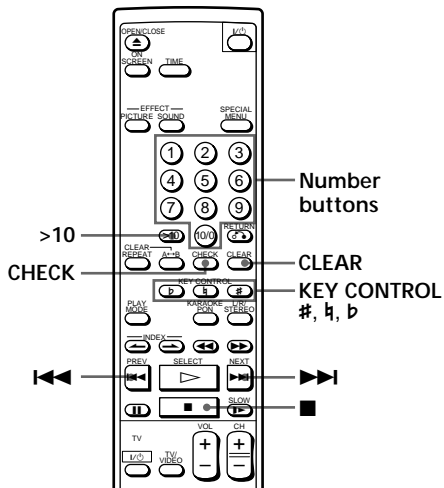
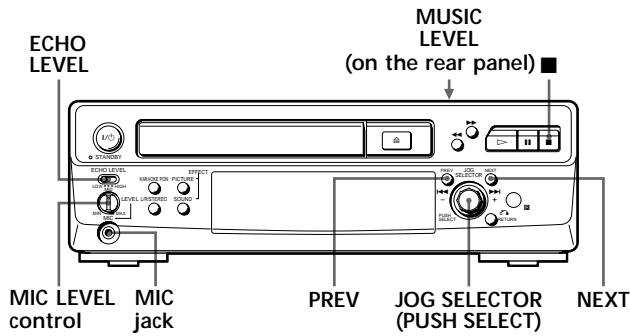

- 1 Set MIC LEVEL to MIN, then plug the microphone into the MIC jack.



- 2 Select the track you want to play.

On the player

Turn JOG SELECTOR until the track number you want to play appears in the front panel display, then press JOG SELECTOR.

On the remote

Press the number button of the track.

To select a track numbered over 10, use the >10 button (see page 18).

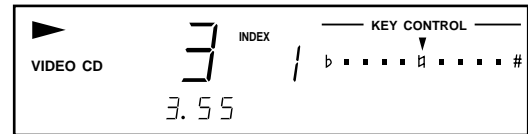

Example: when you select track 3

Play starts automatically.

- 3 Turn MIC LEVEL to adjust the microphone volume.

To stop playback

Press ■.

Notes

- If howling occurs:
  - Move the microphone(s) away from the TV or the speakers.
  - Lower the volume of the TV or the amplifier.
  - Lower the microphone volume or echo level.
- If the sound is distorted when the player is connected to a TV:
  - Lower the microphone volume and music level.
- The microphone volume will be turned off during the search operation.





When you don't use the microphone

Unplug the microphone, switch the microphone off and turn the MIC LEVEL control to MIN.

## Reserving the next tracks to play

Before playing a disc, you can reserve up to 24 tracks to play in any order so that you can enjoy non-stop play.

- 1 Do Steps 1 and 2 on “Creating Your Own Program (Program Play)” on pages 23 and 24.
- 2 Press  $\triangleright$  to start play.

When you want to	Press
Play the current track again	PREV or $\lll$
Go to the next specified track	NEXT or $\ggg$
Check the track order 	CHECK. The tracks appear in the order they were programmed in the front panel display.
Cancel the reservation 	CHECK repeatedly until the track number you want to cancel appears on the front panel display, then press CLEAR
Clear all the reservations	$\blacksquare$ (stop) twice. Create a new program following the above procedure.

## Changing the key (Key Control)

You can change the key to suit your vocal range.

While playing karaoke, press one of the KEY CONTROL buttons repeatedly to find the key that suits your vocal range.

To	Press
Raise the key	#
Lower the key	b
Return to the original key	h

You can adjust the key to 11 steps (5 steps higher, 5 steps lower and the original key).

The setting appears in the front panel display and on the TV screen.

 **When you locate another track during playback**  
The key automatically returns to the original key.

### Note

While you're watching Slide Show, the KEY CONTROL buttons become inoperable.

## Adjusting the echo level

You can give an echo effect to the sound from the microphones.

Set ECHO LEVEL to adjust the strength of echo.

## Adjusting the music level

If you want to reduce the music level, set MUSIC LEVEL on the rear panel to LOW.

This has no effect on the setting of the MIC LEVEL control.

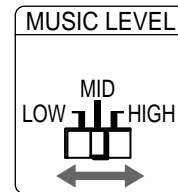

### Note

When playing a CD as a general CD, set the MUSIC LEVEL selector to HIGH.

## Playing VIDEO CDs with PBC Functions (PBC Playback)

When playing VIDEO CDs with PBC functions (Ver. 2.0 discs), you can enjoy playing simple interactive software, software with search functions, etc. PBC Playback allows you to play VIDEO CDs interactively, following the menu screen on the TV screen.

You can use the number buttons, JOG SELECTOR, SELECT, PREV, NEXT and RETURN during PBC Playback.

Also refer to the instructions supplied with the disc, as the operating procedure may differ according to the VIDEO CD.

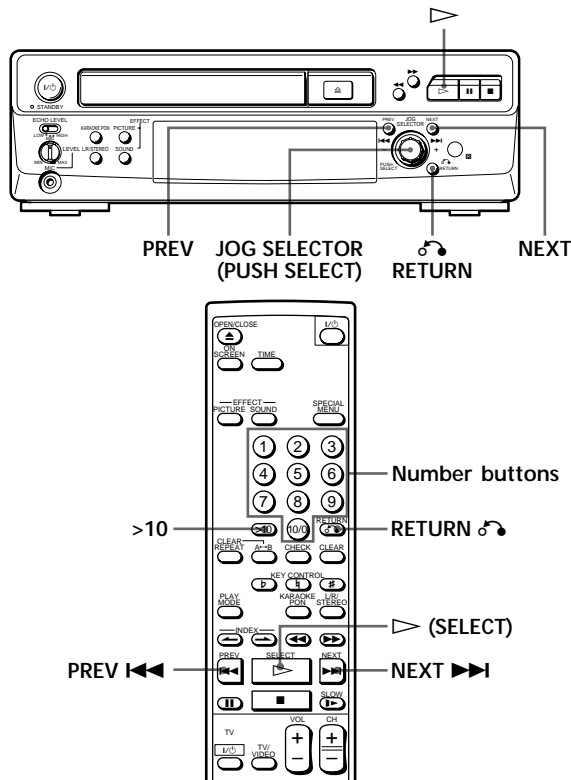

- 1 Start playing a VIDEO CD with PBC functions, following Steps 1 through 4 in "Playing a VIDEO CD" on page 8.

The menu screen appears on the TV screen and "SELECT" flashes.

- 2 Select the item number you want.

On the player

Turn JOG SELECTOR to select the item number, then press JOG SELECTOR.

On the remote

Press the number button of the item you want. When you want to select an item number over 10, press >10 first, then the corresponding number buttons. To enter "0," use button 10/0.

Example: To select item number 30

Press >10 first, then 3 and 10/0.

- 3 Follow the instructions on the menu screen for interactive operations.

When	Do the following
Selecting the item	Turn JOG SELECTOR on the player to select the item number, then press JOG SELECTOR.  Press the number button of the item you want on the remote.
"SELECT" is flashing on the TV screen while playing moving pictures	In this case, you can go to another scene even while playing moving pictures. Turn JOG SELECTOR then press JOG SELECTOR on the player, or press the number button of the item you want on the remote.
Going back to the menu screen	Press RETURN, PREV, or NEXT. (Also refer to the instructions supplied with the disc, as the operating procedure may differ according to the VIDEO CD.)

When "HAND CANNOT OPERATE NOW" appears on the TV screen

You've pressed an invalid button. Press the correct button, following the instructions on the menu screen.

To cancel PBC Playback of a VIDEO CD with PBC functions and play the disc in Continuous Play mode (PBC OFF)

There are two ways.

- Before you start playing, select the track you want with JOG SELECTOR or ◀◀/▶▶, then press JOG SELECTOR or ▷.
- Before you start playing, select the track number using the number buttons on the remote.

"PBC OFF" and "CONTINUE" appear in the front panel display and the player starts Continuous Play. You cannot play still pictures such as a menu screen.

You can use ▷ instead of JOG SELECTOR after turning JOG SELECTOR.

## Note

When you scan the still pictures in the Slide Show, the last picture may not appear.

## Example of PBC Playback

This is an example of PBC Playback. Also refer to the instructions supplied with the disc, as the operating procedure may differ according to the VIDEO CD.

TV screen

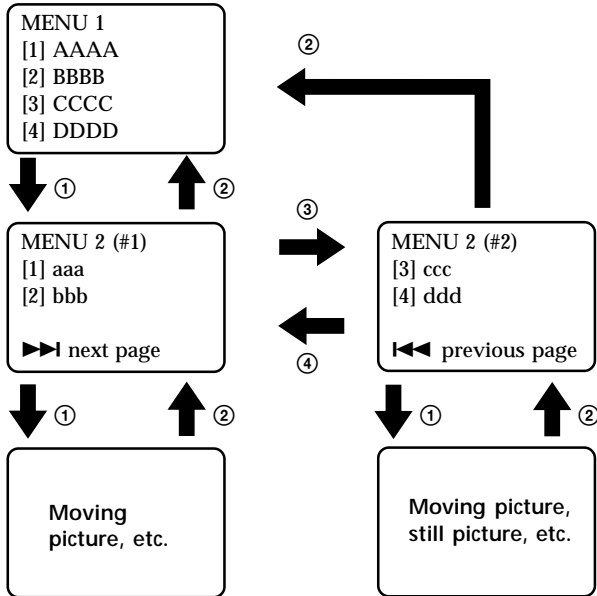

- ① To select the item:  
Turn JOG SELECTOR to select the item number, then press JOG SELECTOR, or select the number button you want on the remote.
- ② To go to the preceding menu:  
Press RETURN .
- ③ To go to the next page of the menu:  
Press NEXT.
- ④ To go back to the preceding page of the menu:  
Press PREV.

## Locating Scenes Directly Using the Scene Numbers (Scene Search)

On VIDEO CDs with PBC functions, the menu screens, moving pictures and still pictures are divided into "scenes" and each scene is assigned with a scene number.

You can check the current scene number by displaying it on the TV screen during playback (see page 15). Be sure to memorize the scene number from which you want to start playing.

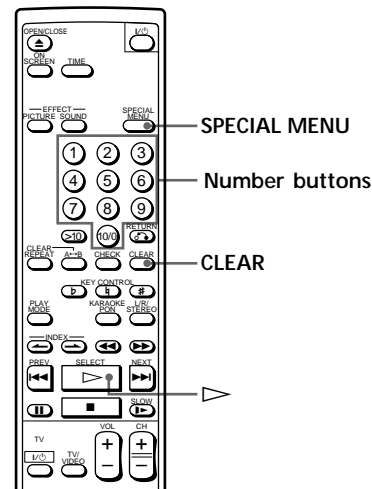

- 1 Press SPECIAL MENU before you start playing or while playing a disc.  
The following menu appears on the TV screen while playing a disc.

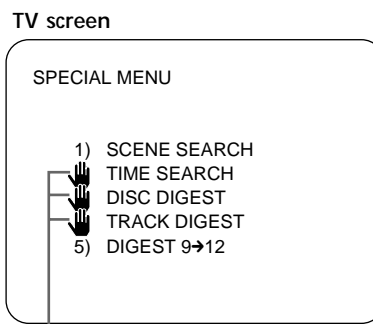

You cannot select the item with this mark.

- 2 Press button 1.  
"SCENE -" and the scene numbers appear on the TV screen.

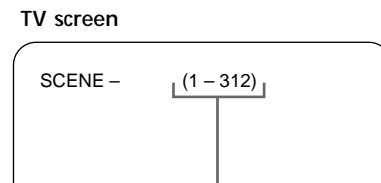

Total scene numbers

(Continued)

- 3** Press the number buttons (1 - 10/0) to select the scene.

To enter "0", use the button 10/0.

Example: To select scene number 103

Press 1, then 10/0 and 3.

The selected scene number appears on the TV screen.

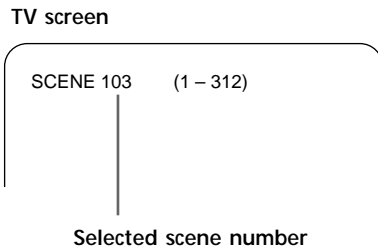

If you've made a mistake

Press CLEAR, then press the correct number button.

- 4** Press  $\triangleright$  to start playing from the selected scene.  
The player automatically starts PBC Playback (page 12).

 You can check the scene number while playing a disc  
Press ON SCREEN repeatedly to select ON SCREEN 2 display mode (see page 15). The scene numbers appear on the upper left side of the TV screen.

### Notes

- Some discs don't allow you to start playing from a particular scene. In this case, when you do the task before you start playing, the player starts playing from scene 1. When you do the task while playing a disc, the player starts playing from the current scene.
- Some discs don't display the selected scene on the TV screen.
- When you select ON SCREEN OFF display mode, no information is shown on the TV screen.

## Using the On-Screen Display

You can check the operating status of the player and the information about the disc with the on-screen display on the TV screen.

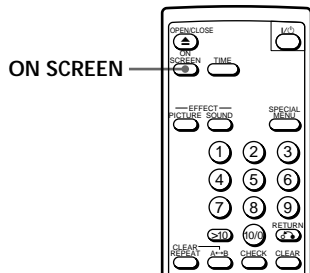

Press ON SCREEN.

Each time you press the button, the on-screen display changes as follows:

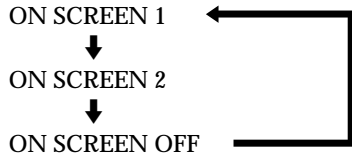

### When using a VIDEO CD

#### ■ Display information of ON SCREEN 1 mode

The operating status is displayed for a few seconds only when you change the operating status.

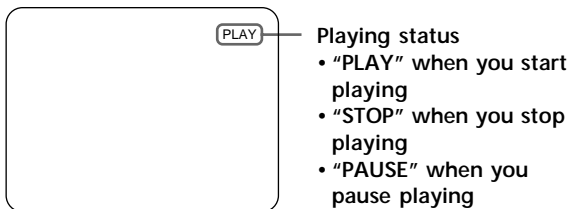

- Before you start playing (except for the Program Play mode)

When Resume Play is available

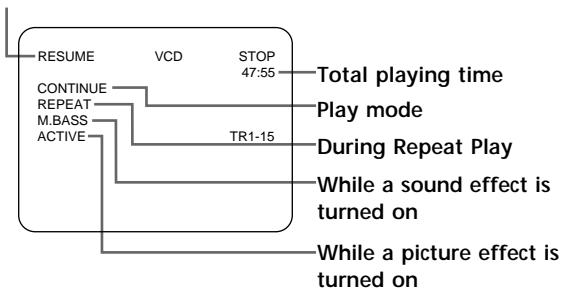

- Before you start playing in Program Play mode

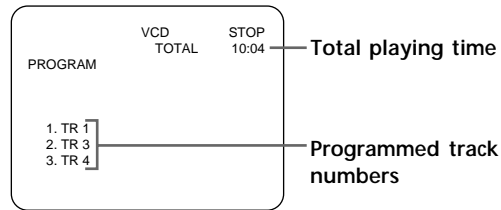

#### ■ Display information of ON SCREEN 2 mode

While playing a disc, the current track number and the playing time are always displayed.

The operating status is displayed for a few seconds only when you change the operating status.

The same information as in ON SCREEN 1 is displayed before you start playing.

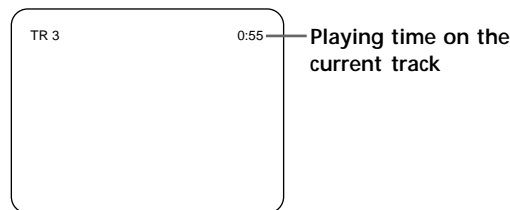

- During PBC Playback (page 12)

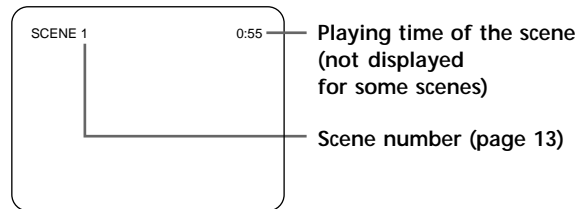

#### ■ Display information of ON SCREEN OFF mode

No information is displayed.

### When using an audio CD

The same information is displayed in ON SCREEN 1 mode and ON SCREEN 2 mode while playing an audio CD.

#### ■ Display information of ON SCREEN 1 or ON SCREEN 2

- In Continuous or Shuffle Play mode

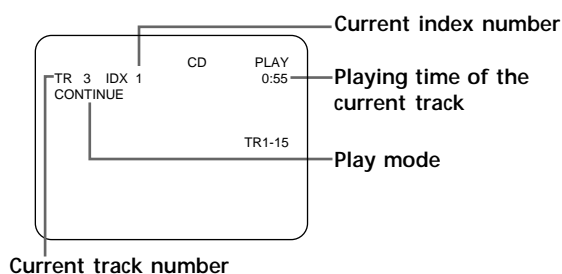

(Continued)

## Locating a Scene or Track You Want

- In Program Play mode

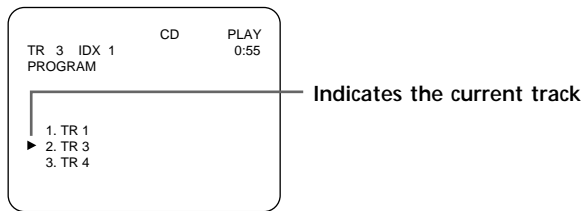

- Before you start playing (except for the Program Play mode)

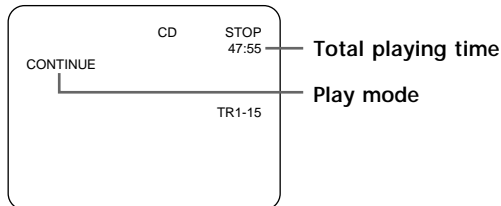

- Before you start playing in Program Play mode

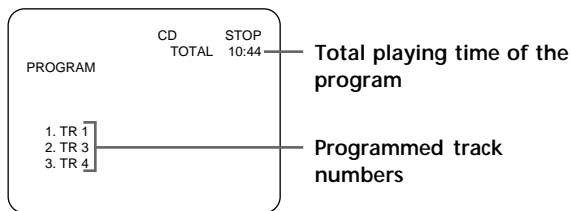

- Display information of ON SCREEN OFF mode  
No information is displayed.

### Notes

- Select the display mode other than ON SCREEN OFF for normal operation. When you select ON SCREEN OFF, you cannot check the operating status while operating the player. In this case, check the information in the front panel display.
- When you record the playback picture of this player on another VCR, etc., be sure to select ON SCREEN OFF. Otherwise, the display information is also recorded on the VCR.

## Using the Front Panel Display

You can check information about the disc using the front panel display.

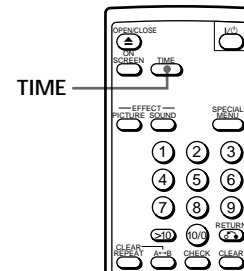

### Checking the total number and playing time of the tracks

Press TIME before you start playing.

The front panel display shows the total number of tracks and total playing time.

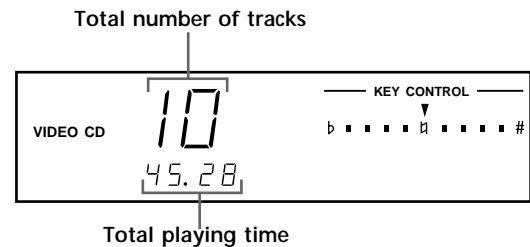

The information also appears when you press the  OPEN/CLOSE button to close the disc tray.

### Display information while playing a disc

While playing an audio CD or a VIDEO CD without PBC functions, the front panel display shows the current track number, playing time of the track and index number (page 19).

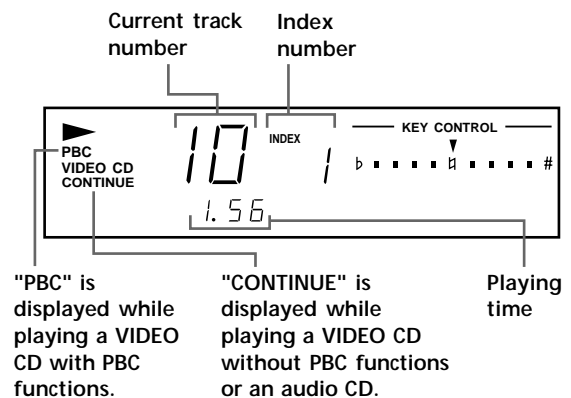



## Checking the remaining time

Each time you press TIME while playing a disc, the display changes as shown in the chart below. Note that you cannot check the remaining time during PBC Playback (page 12).

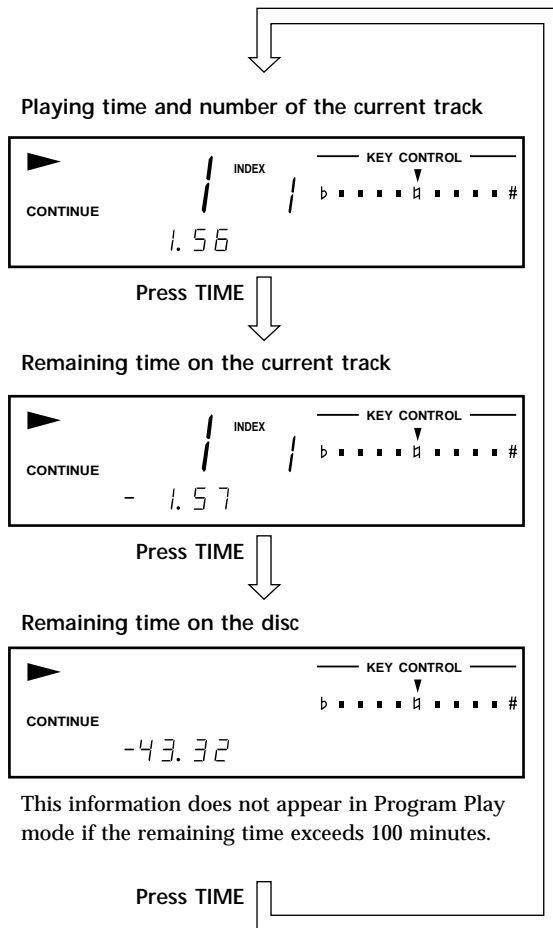

**What is a track?**  
A disc is divided into sections of a picture or a music piece called "tracks." Each track is assigned with a track number to locate the track you want.

## Resuming Playback from the Point You Stopped a Disc (Resume Play)

The player memorizes the point you stopped a disc and you can resume playback from that point. Resume Play is canceled if you unplug the player.

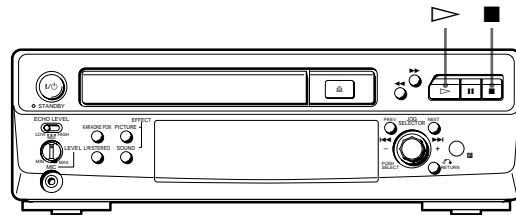

- 1 While playing a disc, press ■ to stop playback. "RESUME" appears in the front panel display and on the TV screen. If "RESUME" doesn't appear, Resume Play is not available.
  - 2 Press ▷. The player starts playback from the point you stopped the disc in Step 1.
- 💡** To view from the beginning of the VIDEO CD  
When "RESUME" appears in the front panel display, press ■, then press ▷.

### Notes

- Resume Play is not available in Digest, Shuffle or Program Play mode.
- Depending on where you stopped the disc, the player may resume playback from a different point.
- If you play a CD audio track in a VIDEO CD with PBC function (see page 12) and resume playback, the background picture may change to blue. However, this is not a malfunction.

## Locating a Specific Track

You can quickly locate any track while playing a disc using the JOG SELECTOR, **◀◀/▶▶** buttons (AMS: Automatic Music Sensor) or number buttons. Note that while playing a VIDEO CD with PBC functions, this function is available only during playback without PBC functions (PBC OFF, page 12).

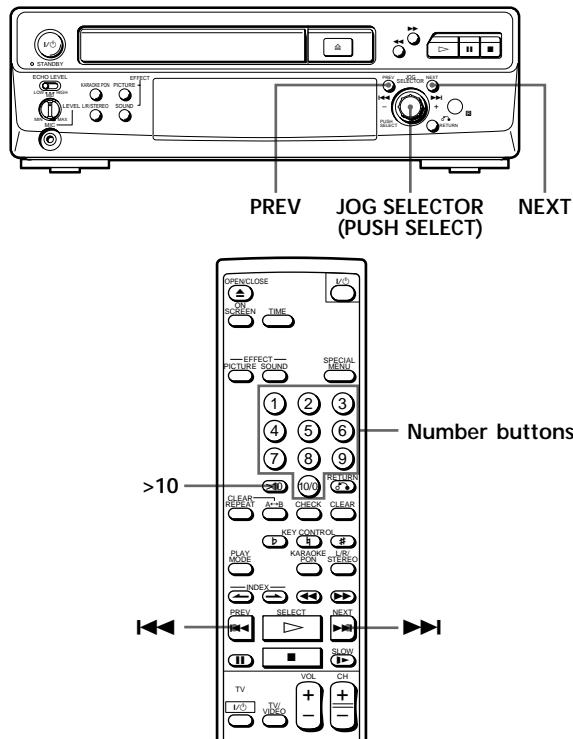

To locate	Press
The next or succeeding tracks (AMS)	NEXT or <b>▶▶</b> repeatedly, or turn JOG SELECTOR clockwise until you find the track
The current or preceding tracks (AMS)	PREV or <b>◀◀</b> repeatedly, or turn JOG SELECTOR counterclockwise until you find the track
A specific track directly	Number button of the track

- When you directly locate a track numbered over 10 Press **>10** first, then the corresponding number buttons. To enter "0," use button 10/0. Example: To play track number 30 Press **>10** first, then 3 and 10/0.

**What is a track?**  
A disc is divided into sections of a picture or a music piece called "tracks." Each track is assigned with a track number to locate the track you want.

**Note**  
During PBC Playback, the JOG SELECTOR, **◀◀** and **▶▶** buttons have different functions from the ones explained in the table above.

## Locating a Point by Elapsed Time (Time Search)

This function lets you use elapsed time as a guide to find a certain point on a VIDEO CD. To use Time Search function with VIDEO CDs with PBC function (Ver. 2.0 discs), see the explanation below. "Elapsed" means the time from the beginning of the disc and is not the playing time of the current track. Time Search function is especially useful when playing discs that have only a few track divisions. This function cannot be used during Digest Play (see page 20).

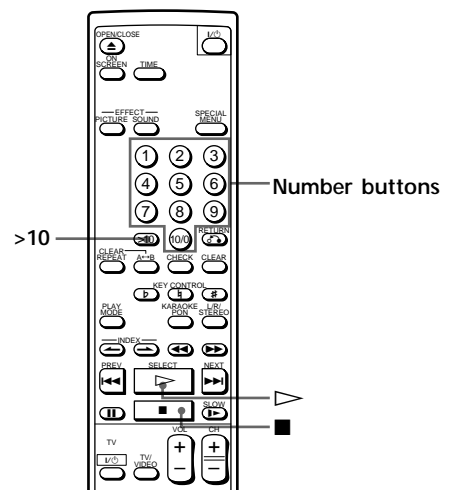

- 1 Press **SPECIAL MENU** while playing a disc or before you start playing. The following menu appears on the TV screen.

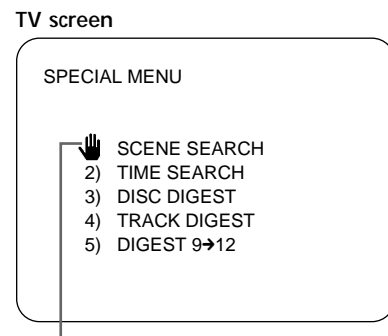

- You cannot select the item with this mark.
- 2 Press button 2.
  - 3 Press the number buttons to enter the time (in minutes) of the point that you want to locate. The entered time appears on the TV screen.
  - 4 Press **▷**. Playback starts from the entered time.

To use Time Search function with VIDEO CDs with PBC function (Ver. 2.0 discs)  
Do Steps 1 and 2 above before you start playing the VIDEO CD so that "PBC OFF" appears in the front panel display.

## Locating a Particular Point in a Scene or Track

You can also locate a particular point in a scene or track while playing a disc. During PBC Playback (page 12), this function is available only while playing moving pictures. While playing an audio CD or a CD audio track in a VIDEO CD, changing the search speed while locating a point or Slow-motion Play is not available.

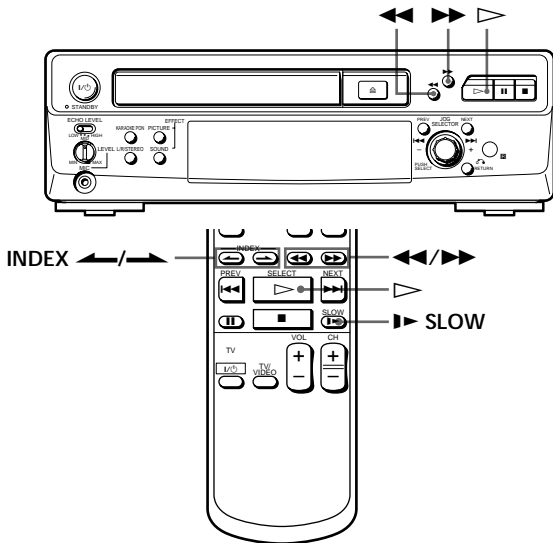

To locate a point	Press
While monitoring the picture or sound	▶▶ (forward) or ◀◀ (backward) repeatedly to select the speed (▶▶ or ◀◀ 1, ▶▶ or ◀◀ 2, or ▶▶ or ◀◀ 3). When you find the point, press ▷ to return to the normal speed. You will not hear the sound while playing a VIDEO CD. Note that you cannot change the search speed on audio CDs.
Slowly by observing the TV screen (Slow-motion Play)	▶▶ SLOW. You will not hear the sound during the operation. When you find the point, press ▷ to return to the normal speed.

If you want to locate a particular point of a long track  
It is convenient to use Track Digest (see page 21).

If "⌂ ⌂" appears in the front panel display  
The disc has reached the end after you pressed ▶▶. Press ◀◀ or ◀◀ to go back.

If you want to change the playback speed during Slow-motion Play   
Press ▶▶ SLOW repeatedly until you find the playback speed you want. Three speeds are available: SLOW 1, SLOW 2 and SLOW 3. Each time you press the button, the indication changes as follows.

→ SLOW 1 → SLOW 2 → SLOW 3 →

### Notes

- While playing a VIDEO CD, the picture may be distorted during the search operation.
- While playing an audio CD or a CD audio track in a VIDEO CD, you can also locate a point as in the table in the left column.

## Locating a point using the index (Index Search)

There are two kinds of indexes: one is for audio CDs and the other is for VIDEO CDs. You can locate a point you want using the index.

Note that this function is available only for indexed discs. Also note that you cannot search indexes in different tracks.

While playing a track, press INDEX ◀ or ▶ repeatedly.

- To locate the current or preceding index numbers, press INDEX ◀.
- To locate the next or subsequent index numbers, press INDEX ▶.

### Front panel display

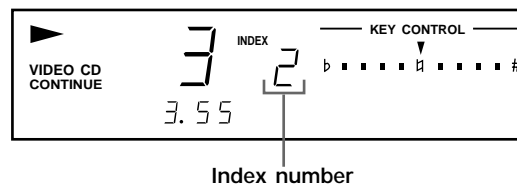

TV screen (when you press ◀ or ▶ while playing a VIDEO CD)  
ON SCREEN 1 or 2 display mode

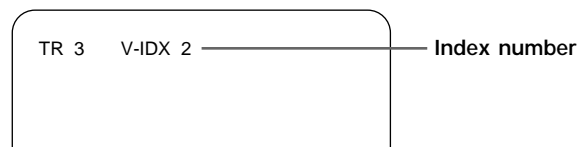

TV screen (while playing an audio CD)  
ON SCREEN 1 or 2 display mode

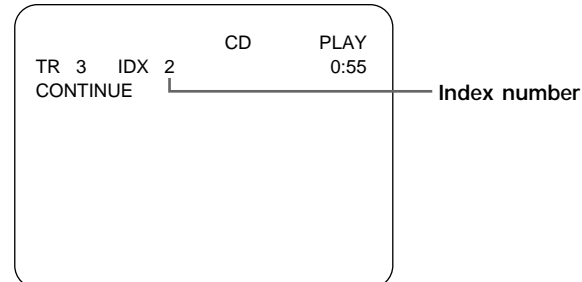

### What is an index?

It is a number that divides a track or a disc into some sections in order to easily locate the point you want. You may determine if a disc uses index by looking at the disc's packaging.

### Note

If there are no more indexes while playing a VIDEO CD, "CANNOT OPERATE NOW" appears on the TV screen and the player continues playing.

## Locating by Observing Several Scenes at One Time (Digest Play)

You can locate the track or scene you want by observing several still pictures at one time on the TV screen. You can also select the number of still pictures. Note that while playing a VIDEO CD with PBC functions, this function is available before you start playing or during playback without PBC functions (PBC OFF, page 12).

While playing a VIDEO CD, you will not hear the sound.

While playing an audio CD, you will only hear the sound.

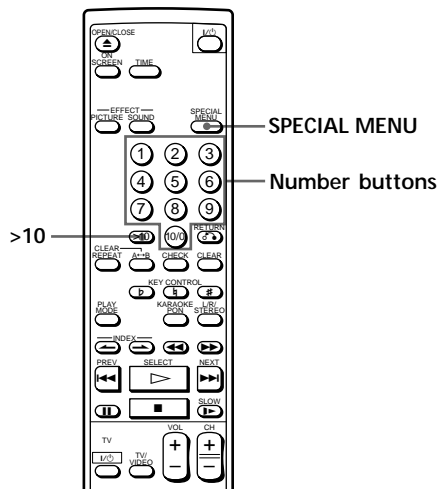

## Locating the track you want on a disc (Disc Digest)

You can locate the track you want by observing the first picture of up to 9 or 12 tracks on the disc at one time on the TV screen.

- 1 Press SPECIAL MENU while playing a disc or before you start playing. The following menu appears on the TV screen.

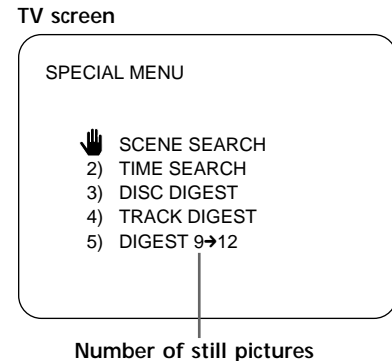

- 2 Press button 3. While playing a VIDEO CD, the TV screen shows still pictures of the first scenes of tracks 1 to 9 or 12 on the disc. While playing an audio CD, the beginnings of each track are played in sequence. → shows the track that the player is currently playing.

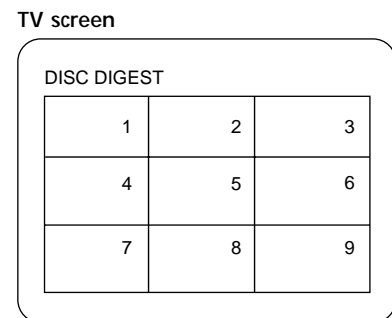

## Specifying the number of still pictures

You can select either 9 or 12 of still pictures that appear on the TV screen during Disc Digest and Track Digest.

- 1 Press SPECIAL MENU while playing a disc or before you start playing. The following menu appears on the TV screen.

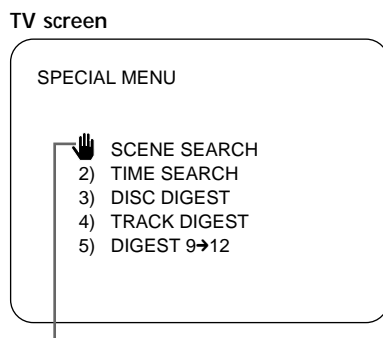

- 2 Press button 5. Each time you press the button, the number toggles between 9 and 12. Select 9→12 for 9 still pictures; select 12→9 for 12 still pictures.

To view still pictures of the tracks numbered over 9 Press ►►. The TV screen shows still pictures of tracks 10 to 18 or 13 to 24.

If there are more tracks, "►►" is displayed on the upper right side of the TV screen.

To go back to the previous screen, press ◀◀.

- 3** Press the number button to select the track.  
The player starts playing from the selected track.  
  
To select tracks numbered over 10  
Use the >10 button (see page 18).

To cancel Disc Digest

Press ■.

### Notes

- The operable item of the special menu is different depending on discs or PBC function ON/OFF setting.
- If you start Disc Digest before you start playing a VIDEO CD with PBC functions, the player automatically starts playing without PBC functions (PBC OFF, page 12).
- When you start Disc Digest in Shuffle or Program Play mode, the player automatically enters Continuous Play mode (page 8).

## Locating the point you want in a track (Track Digest)

You can have the player divide a track into 9 or 12 sections. You can locate the point you want by viewing the first picture of each section at one time on the TV screen. This might be useful when you play a disc which is divided into few tracks, such as a movie.

- 1** Press SPECIAL MENU while playing a disc or before you start playing.  
The following menu appears on the TV screen.

TV screen

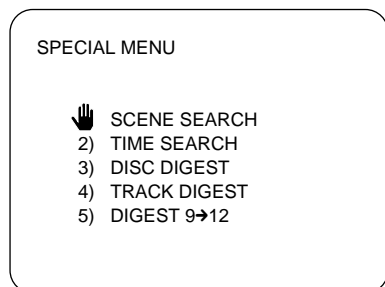

- 2** Press button 4.  
While playing a VIDEO CD, the player divides the track into 9 or 12 sections and the TV screen shows still pictures of each section in order.  
While playing an audio CD, the player divides the track into 9 to 12 sections and plays the beginnings of each section in sequence. → shows the section that the player is currently playing.

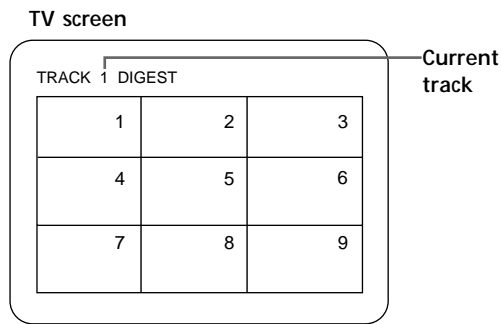

- 3** Press the corresponding number button to select the point you want.  
The player starts playing from the selected point.  
The player may start playing from a point which is a little different from the one displayed during Track Digest.

To cancel Track Digest

Press ■.

- 💡 You can select a point which isn't displayed yet on the TV screen in Step 2

- 💡 During Track Digest, you can start Track Digest on another track  
Press ◀◀ or ▶▶.  
Note that this function is not available in Shuffle or Program Play mode.

### Notes

- If you start Track Digest before you start playing a VIDEO CD with PBC functions, the player automatically starts playing without PBC functions (PBC OFF, page 12).
- If you start Track Digest before you start playing in Shuffle or Program Play mode, the player automatically enters Continuous Play mode (page 8).
- When a track is shorter than about 40 seconds, the player may divide the track into less than 9 or 12 sections.

## Playing Repeatedly

You can play all the tracks, a single track or a specific portion repeatedly.

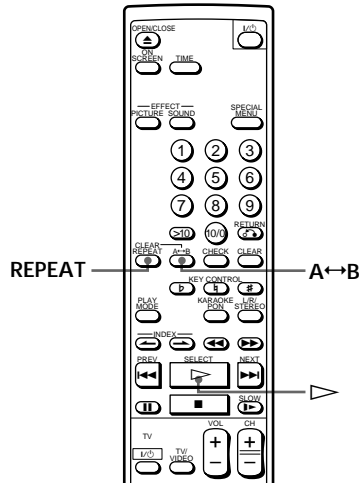

### Repeating all the tracks on a disc

In Shuffle or Program Play mode, the player repeats the track in the shuffled or programmed order. You cannot do Repeat Play during PBC playback (page 12) or Digest Play (page 20).

Press REPEAT while playing a disc. "REPEAT" appears in the front panel display. The player repeats the tracks as follows:

When the disc is played in	The player repeats
Continuous Play (page 8)	All the tracks
Shuffle Play (page 23)	All the tracks in random order
Program Play (page 23)	The same program

#### To cancel Repeat Play

Press REPEAT repeatedly until "REPEAT" disappears from the front panel display.

### Repeating the current track

You can repeat only the current track in Continuous Play mode (page 8).

While the track you want is being played, press REPEAT repeatedly until "REPEAT1" appears in the front panel display.

#### To cancel repeating the current track

Press REPEAT repeatedly until "REPEAT1" disappears from the front panel display.

### Repeating a specific portion (A↔B Repeat)

You can play a specific portion in a track repeatedly. This might be useful when you want to memorize lyrics.

During PBC Playback (page 12), this function is available only while playing moving pictures.

- 1 While playing a disc, press A↔B when you find the starting point (point A) to be played repeatedly.  
"A-" of "REPEAT A-" flashes in the front panel display.
- 2 When you reach the ending point (point B), press A↔B again.  
"REPEAT A-B" appears. The player plays this specific portion repeatedly.

#### To cancel A↔B Repeat

Press REPEAT.

-  When you want to restart from the starting point A  
Press ▷ during A↔B Repeat.

#### Note

If you start Slow-motion Play during A↔B Repeat, Slow-motion Play is canceled when the player returns to the point A.

## Playing in Random Order (Shuffle Play)

You can have the player “shuffle” tracks and play in a random order.

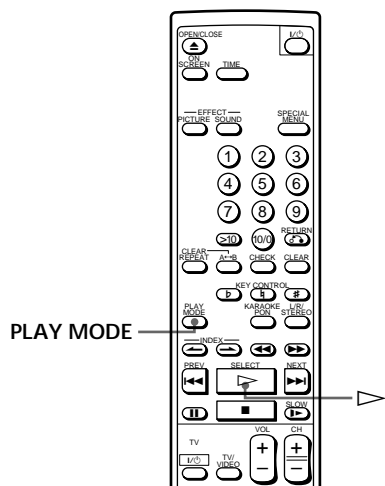

- 1 Press PLAY MODE repeatedly until “SHUFFLE” appears in the front panel display.

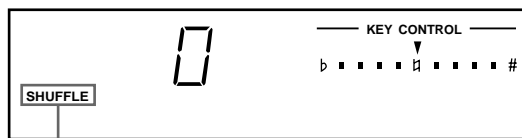

“SHUFFLE” is lit

- 2 Press to start Shuffle Play. The indication appears while the player is “shuffling” the tracks.

### To cancel Shuffle Play

Press PLAY MODE repeatedly until “CONTINUE” appears in the front panel display. (When you want to play a VIDEO CD with PBC functions, be sure to press PLAY MODE repeatedly until “SHUFFLE” disappears from the front panel display.)

- You can start Shuffle Play while playing in Continuous Play mode

Press PLAY MODE repeatedly until “SHUFFLE” appears in the front panel display. Shuffle Play starts from the current track.

### Note

If you play a VIDEO CD with PBC functions in Shuffle Play mode, you cannot use the PBC functions.

## Creating Your Own Program (Program Play)

You can arrange the order of the tracks on the discs and create your own program. The program can contain up to 24 tracks.

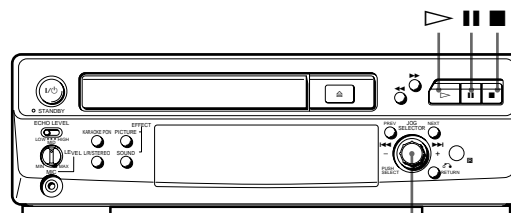

JOG SELECTOR (PUSH SELECT)

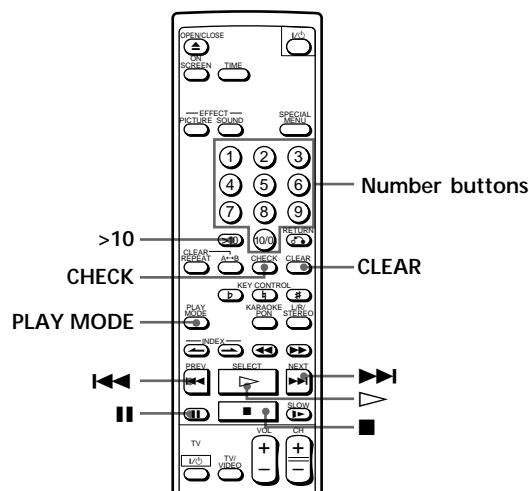

- 1 Press PLAY MODE repeatedly until “PROGRAM” appears in the front panel display.

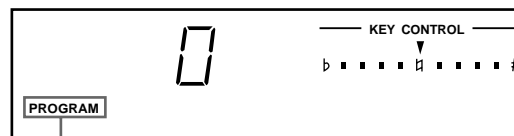

“PROGRAM” is lit

(Continued)

## 2 Select the tracks you want to program.

### On the player

Turn JOG SELECTOR until the track number you want to program appears in the front panel display, then press JOG SELECTOR or PLAY MODE.

### On the remote

Press the number buttons of the tracks you want to program in the order you want.

Example: To program the tracks in the order 2, 8, 5  
Press the number buttons 2 → 8 → 5.

To program a track numbered over 10, use the >10 button (see page 18).

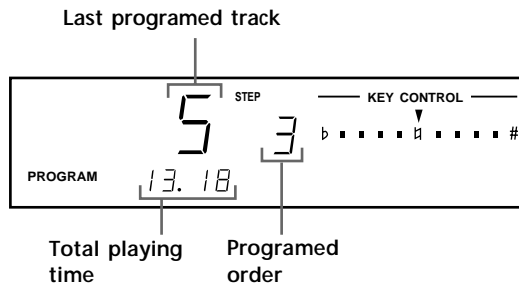

### If you've made a mistake

Press CLEAR, then press the correct number button.

## 3 Press ▷ to start Program Play.

### To cancel Program Play

Press PLAY MODE repeatedly until "CONTINUE" appears in the front panel display. (When you want to play a VIDEO CD with PBC functions, be sure to press PLAY MODE repeatedly until "PROGRAM" disappears from the front panel display.)

### You can check the total playing time while programming in Step 2 (Program Edit)

- 1 Turn JOG SELECTOR or press ◀◀ or ▶▶ until the track you want to program appears in the front panel display.  
The total playing time including the selected track appears in the front panel display.
- 2 Press JOG SELECTOR or PLAY MODE to confirm your selection.
- 3 Repeat Steps 1 and 2 to program more tracks.

### You can insert a pause as one step

During programming, press || to insert a pause. The total playing time is reset to "0.00."

When playing a program which contains a pause, the player pauses at the step in which a pause is programmed, until you press || or ▷. This might be useful when you record a program on both sides of a tape.

You can check the contents of the program during programming on the TV screen  
If you press ON SCREEN to select ON SCREEN OFF display mode, you won't see this information (page 15).

The program remains even after the Program Play ends  
When you press ▷, you can play the same program again.

### Notes

- If you play a VIDEO CD with PBC functions in Program Play mode, you cannot use PBC functions (page 12).
- If the total playing time exceeds 100 minutes, "--. --" appears in the front panel display.
- If you program more than 24 tracks, "FULL" appears in the front panel display and on the TV screen.

## Checking the track order

You can check your program before or after you start playing.

Press CHECK.

Each time you press this button, the front panel display shows the track number and the total playing time in the programmed order. After the last track in the program, the front panel display shows "End" and returns to the original display.

## Changing the track order

You can change your program before you start playing.

To	Press
Erase a track	CHECK until the track you don't want appears in the display, then press CLEAR.
Erase the last track in the program	CLEAR. Each time you press this button, the last track is cleared.
Add tracks to the end of the program	Number buttons of the tracks to be added on the remote, or turn JOG SELECTOR until the track number you want appears in the display then press JOG SELECTOR.
Change the whole program completely	■ (stop). Create a new program following the programming procedure.



## Enjoying Picture Effects

You will get a clear-cut picture by emphasizing the outline of the pictures without increasing noise on the picture or you can enjoy a picture which luminance is reduced just like the picture on the movie theater screen.

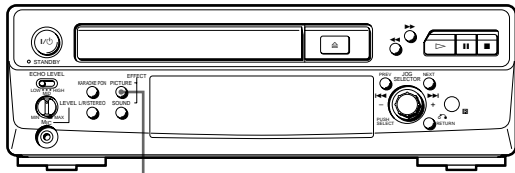

EFFECT PICTURE

### Getting a clear-cut picture (Active Picture)

Press EFFECT PICTURE repeatedly until "ACTIVE" appears in the front panel display.

### Getting a movie-theater-like picture (Theater Picture)

Press EFFECT PICTURE repeatedly until "THEATER" appears in the front panel display.

#### To cancel the picture effect

Press EFFECT PICTURE repeatedly until "ACTIVE" or "THEATER" disappears from the front panel display.

#### Note

The Active Picture and Theater Picture functions are not available while playing an audio CD.

## Enjoying Sound Effects

You can play a disc with one of two acoustic atmospheres: M(ega).BASS or EX(tra).WIDE.



EFFECT SOUND

While playing a disc, press EFFECT SOUND repeatedly until the desired effect appears in the front panel display.

Effect mode	Atmosphere
M.BASS	Emphasizes the bass
EX.WIDE	Provides a greater sense of expanse

#### To cancel the sound effect

Press EFFECT SOUND repeatedly until "M.BASS" or "EX.WIDE" disappears from the front panel display.

## Switching the Sound

On multiplex discs, you can select the sound from the right or left channel and listen to the sound of the selected channel through both the right and left speakers. In this case, the sound loses the stereo effect.

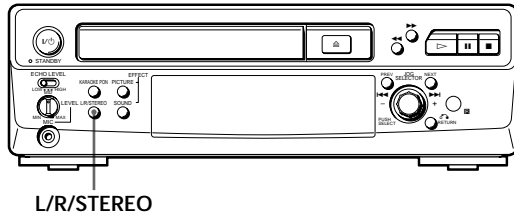

Press L/R/STEREO while playing a disc. Each time you press the button, the indication and the sound from the speakers change as follows:

Press	Indication*	You will hear
Once	MONO L	The sound of the left channel
Twice	MONO R	The sound of the right channel
Three times	STEREO**	The standard stereo sound

\* When you select ON SCREEN OFF display mode, check the indication on the front panel display.

\*\* This indication doesn't appear in the front panel display.

## Controlling the TV with the Supplied Remote

You can control Sony TVs with the  mark using the supplied remote.

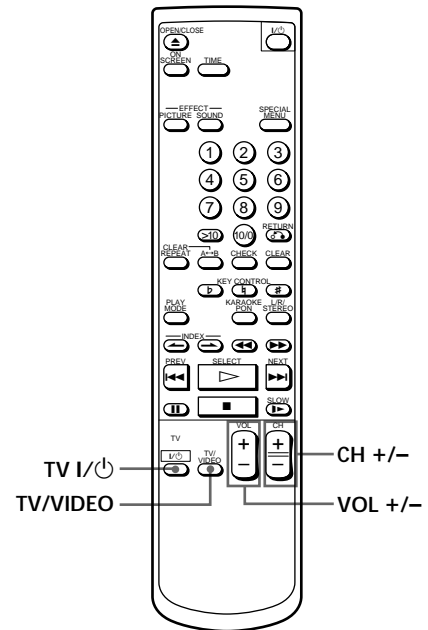

Press	You can
TV I/ON	Turn on or off the TV
TV/VIDEO	Select the input source to the TV
VOL +/-	Adjust the volume of the TV
CH +/-	Change the channel of the TV

### Playing Karaoke with Any Stereo Discs (Karaoke Pon)

You can enjoy karaoke with a stereo-recorded disc, even if it is a non-karaoke disc, by reducing the singer's voice.

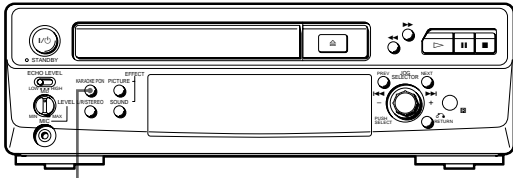

KARAOKE PON

Press KARAOKE PON.

“K. PON” appears in the front panel display and on the TV screen.

This reduces the singer's voice so that you can enjoy karaoke. However, this also reduces the stereo effect.

To cancel Karaoke Pon

Press KARAOKE PON again. “K. PON” disappears from the front panel display.



**When you use Karaoke Pon**

Use stereo-recorded discs.

#### Notes

- Karaoke Pon may not work well for the following cases:
  - Monaural-recorded discs (The accompaniment is also reduced.)
  - Only a few instruments are playing in the stereo-recorded disc
  - A duet is being played
  - The disc has strong echoes or chorus
  - The singer's voice on the disc deviates from the center
  - Multiplex discs
- When you select ON SCREEN OFF display mode, no information is shown on the TV screen.
- When you turn on the Karaoke Pon function, EX.WIDE sound effect turns off automatically; when you turn off the function, EX.WIDE sound effect turns on automatically.

### Notes on Discs

#### On handling discs

- To keep the disc clean, handle the disc by its edge. Do not touch the surface.
- Do not stick paper or tape on the disc.  
If there is glue (or a similar substance) on the disc, remove the glue completely before using the disc.

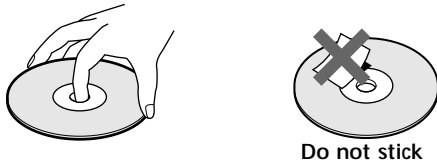

- Do not expose the disc to direct sunlight or heat sources such as hot air ducts, or leave it in a car parked in direct sunlight as there can be considerable rise in temperature inside the car.
- After playing, store the disc in its case.
- Only regular circular discs can be used in this VIDEO CD player. Irregularly shaped discs, such as star- or heart-shaped discs, may damage the player.

#### On cleaning

- Before playing, clean the disc with a cleaning cloth. Wipe the disc from the center out.

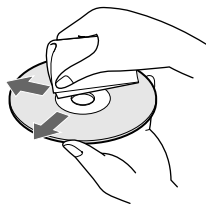

- Do not use solvents such as benzene, thinner, commercially available cleaners or anti-static spray intended for vinyl LPs.

### Troubleshooting

If you experience any of the following difficulties while using the player, use this troubleshooting guide to help you remedy the problem. Should any problem persist, consult your nearest Sony dealer.

#### There's no sound.

- ➔ Check that the player is connected securely.
- ➔ Make sure you operate the TV or the amplifier correctly.
- ➔ Make sure you select the CD player position on the amplifier.

#### There's no picture.

- ➔ Check that the player is connected securely.
- ➔ Make sure you operate the TV correctly.
- ➔ Make sure you set the COLOR SYSTEM switch correctly, according to your TV.

#### The picture is distorted.

- ➔ Clean the disc (see page 28).

#### The disc doesn't play.

- ➔ There's no disc inside ("no dISC" appears).  
Insert a disc.
- ➔ Insert the disc with the label side up on the disc tray correctly.
- ➔ Clean the disc (see page 28).
- ➔ Moisture has condensed inside the player. Remove the disc and leave the player turned on for about an hour (see page 2).

#### The sound loses stereo effect.

- ➔ "MONO R" or "MONO L" appears in the front panel display (see page 26).

#### The remote doesn't function.

- ➔ Remove the obstacles in the path of the remote and the player.
- ➔ Point the remote at the remote sensor g on the player.
- ➔ Replace all the batteries in the remote with new ones if they are weak.

#### There's no sound from the microphone.

- ➔ Switch the microphone on.
- ➔ Turn the MIC LEVEL control clockwise.

#### Howling occurs.

- ➔ Move the microphone away from the speakers.
- ➔ Lower the volume.
- ➔ Lower the microphone volume or echo level.

The player doesn't play from the first track when playing a VIDEO CD without PBC functions or an audio CD.

- ➔ Press PLAY MODE repeatedly until "CONTINUE" appears in the front panel display, then press ▷.

## Specifications

### VIDEO CD player

Laser Semiconductor laser ( $\lambda = 780 \text{ nm}$ )  
Emission duration: continuous

Laser output\* Max 44.6  $\mu\text{W}$

\* This output is the value measured at a distance of 200 mm from the objective lens surface on the Optical Pick-up Block with 7 mm aperture.

Wavelength 780 - 790 nm

Signal format system NTSC, PAL

Frequency response 2 Hz to 20 kHz  $\pm 1.0 \text{ dB}$

### Outputs

	Jack type	Maximum output level	Load impedance
AUDIO OUT	Phono jacks	1.43 V (at 100 kilohms)	Over 10 kilohms
VIDEO OUT	Phono jack	1 Vp-p	75 ohms, unbalanced, sync negative, white peak
S VIDEO OUT	4-pin mini DIN	Y: 1 Vp-p C: 0.286 Vp-p	75 ohms, unbalanced, sync negative

### Inputs

	Jack type	Maximum input level	Load impedance
MIC	Mini-jack	100 mVp-p	600 ohms

### General

Power requirements (model for Thai)  
220 V AC, 50/60 Hz  
(model for other countries)  
110 - 120 V or 220 - 240 V AC, adjustable, 50/60 Hz

Power consumption 24 W

Dimensions (approx.) (w/h/d) 280  $\times$  91  $\times$  285 mm incl. projecting parts

Mass (approx.) 2.9 kg

### Supplied accessories

Audio and video connecting cord (3 phono plugs - 3 phono plugs) (1)

Remote commander (remote) RMT-F88V (1)

Sony R6 (size AA) batteries (2)

Design and specifications are subject to change without notice.

## Glossary

### Auto Pause

Automatic pause function that works according to the signal encoded on the disc during PBC playback. In this case, "AUTO" appears in the front panel display. If the player doesn't resume play for a long time, press **II** or **⏏** to resume play manually.

### PBC Playback

Playback using the menu screens recorded on VIDEO CDs with PBC functions. You can enjoy simple interactive operations using the PBC Playback function.

### Playback Control (PBC)

Signals encoded on VIDEO CDs (Version 2.0) to control playback.

By using menu screens recorded on VIDEO CDs with PBC functions, you can enjoy playing simple interactive software, software with search functions, and so on.

When you insert a VIDEO CD with PBC functions on this player, "PBC" appears in the front panel display.

### Track

Sections of a picture or a music piece on a disc. Each track is assigned with a track number to locate the track you want.

### VIDEO CD

A compact disc that contains moving pictures. The picture information uses the MPEG 1 format, one of the world wide standards of digital compact technology. The picture information is compressed about 120 times. Consequently, a 12 cm VIDEO CD can contain up to 74 minutes of moving pictures.

VIDEO CDs also contain compact audio information. Sounds outside the range of human hearing are compressed while the sounds we can hear aren't compressed. VIDEO CDs can hold 6 times the audio information of conventional audio CDs.

There are 2 versions of VIDEO CDs.

- Version 1.1: You can play only moving pictures and sounds.
- Version 2.0: You can play high-resolution still pictures and enjoy PBC functions.

This player conforms to both versions.

## Index

## A, B

- A-B repeat 22
- Active picture 25
- Adjusting
  - echo level 11
  - microphone volume 10
  - music level 11
  - volume 8
- AMS 18
- Auto Pause 29
- Automatic Music Sensor. *See* AMS

## C

- Color system switch 6
- Connecting 5
- Continuous play 8

## D, E

- Digest Play 20
- Disc Digest 20
- Display
  - front panel display 16
  - on-screen display 15

## F, G

- Front panel display 16

## H

- Handling CDs 28
- Hooking up 5

## I, J, K

- Index 19
- Index Search 19

## L, M, N

- Locating
  - a specific point 19
  - a specific scene 19
  - a specific track 18
  - by monitoring 19
  - by observing the front panel display 19
  - directly 18
  - using AMS 18
  - using index 19

## O

- On-screen display 15

## P, Q

- PBC functions 12, 29
- PBC Playback 12, 29
- Playback
  - Continuous Play 8
  - Program Play 23
  - Repeat Play 22
  - Shuffle Play 23
- Program
  - changing 24
  - checking 24

## R

- Remaining time 17
- Remote control 4
- Repeating 22
- Resume Play 17

## S

- Scene 13
- Scene Search 13
- Searching. *See* Locating
- Shuffle Play 23
- Slow-motion Play 19
- Specifying number of still pictures 20
- Switching the sound 26

## T

- Theater picture 25
- Time search 15
- Total playing time 17
- Track Digest 21
- Troubleshooting 28

## U

- Unpacking 4

## V, W, X, Y, Z

- VIDEO CDs 4, 8, 29
- Voltage selector 7

## Names of controls

## Buttons

- A↔B 22
- CH +/- 26
- CHECK 10, 23
- CLEAR 10, 13, 23
- EFFECT PICTURE 25
- EFFECT SOUND 25
- INDEX ◀/▶ 19
- KARAOKE PON 27
- KEY CONTROL #1 10
- L/R/STEREO 26
- Number 10, 12, 13, 18, 20, 23
- ON SCREEN 15
- PLAY MODE 23
- PREV/NEXT 9, 10, 12, 18
- REPEAT 22
- RETURN ⏪ 12
- SPECIAL MENU 13, 20
- ▶ SLOW 19
- TIME 16
- TV/VIDEO 26
- VOL +/- 26
- ⊞ 8, 9
- ▷ 8-10, 12, 13, 17-19, 22, 23
- ▣ 9, 23
- 9, 10, 17, 18, 23
- ◀◀/▶▶ 9, 10, 12, 18, 23
- ◀◀/▶▶ 19
- >10 10, 12, 18, 20, 23

## Switch

- MUSIC LEVEL 10
- TV I/⏻ 26
- I/⏻ (on/standby) 8

## Control

- ECHO LEVEL 10
- JOG SELECTOR 9, 10, 12, 18, 23
- MIC LEVEL 10

## Jack

- MIC 10

## Others

- Disc tray 8
- Front panel display 16
- Ⓜ 4



