

Adjusting the audio emphasis (DYNAMIC SOUND SYSTEM)

Using the 5 BAND GRAPHIC EQUALIZER

Use	To adjust
BALANCE	Stereo imaging.
MEGA BASS	Deep bass sound.
400 Hz	Speaking voice, middle frequencies of instrumental music.
1 kHz	Presence of vocals.
4 kHz	Brightness of the sound.
10 kHz	High treble sounds or to reduce high frequency noise/tape hiss.

Using the PRESET MODE

Use	To
MANUAL	Adjust the sound using the GRAPHIC EQUALIZER.
DISCO	Get powerful, clear sounds emphasizing low and high range audio.
PARTY	Get light, bright sounds emphasizing high and middle range audio.
LIVE	Get wide-ranging sounds having presence.

Note

When adjusting the 5 BAND GRAPHIC EQUALIZER, be sure to set the PRESET MODE to MANUAL. The graphic equalizer will not work in any other position.

Connecting optional components

Before making connections, be sure to turn off the power of the component and set FUNCTION to TAPE/RADIO OFF on the player.

Listening to Audio Components

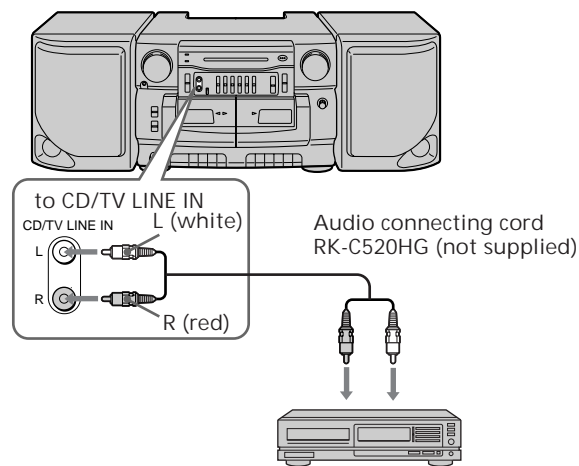

After connecting the component, set FUNCTION to CD/TV LINE IN and play the connected component.

Tip

You can record the sound of the connected component. Insert a cassette, and press ● REC on deck B.

Note

Connect the cables firmly to avoid any malfunction.

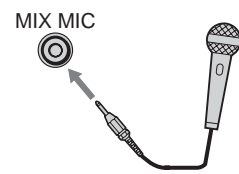

Using the Microphone

Turn on the microphone (not supplied) if it has a power switch.

Tips

- To mix radio or tape sounds and your voice, play the sound you want, and speak or sing into the microphone.
- To use the player as a public address system, set FUNCTION to CD/TV LINE IN, and speak into the microphone.

Note

If acoustic feedback (howling) occurs, turn down the volume or move the microphone away from the speakers.

Setting up the system

Connecting the Speakers

Make sure you turn off the power before making connections.

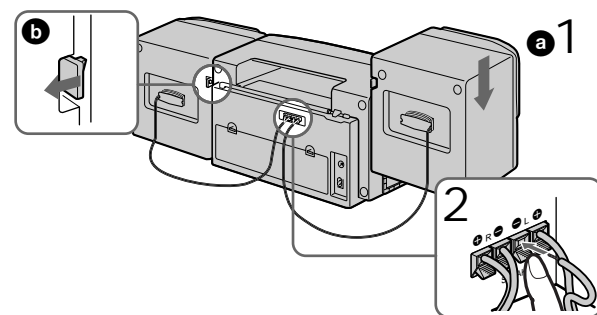

1 Align the grooves and slide the speaker box down until it snaps into place **a**.

2 Connect the black wires to (-) minus and the red wires to (+) plus terminals: the right speaker wires to the R (right), and the left speaker wires to the L (left) terminals.

Tip

To detach the speakers, unlock the speaker **b** and slide the speaker box all the way up and away from the player.

Choosing Power Sources

To use the player on AC power source (mains)
Connect the supplied AC power cord to the AC IN jack.

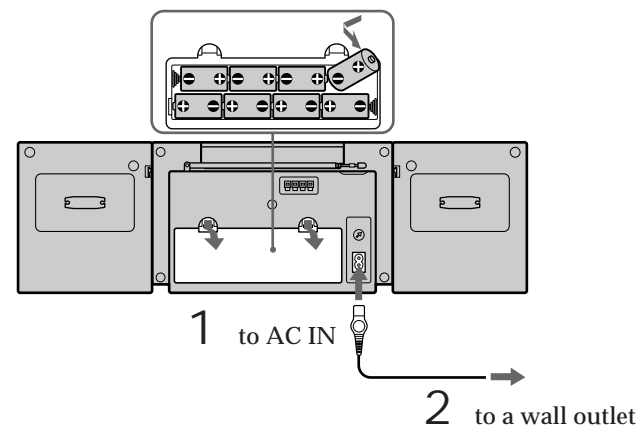

To use the player on batteries

Insert eight R20 (size D) batteries (not supplied) into the battery compartment.

To adjust the voltage

Be sure to set the VOLTAGE SELECTOR (at the rear) to your local power supply.

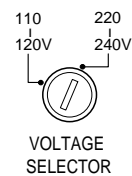

Tip

For customers supplied with an AC plug adaptor, use it if the plug of the mains lead does not match your mains.

Notes

- To use the player on batteries, disconnect the mains lead from the player.
- Replace the batteries when the OPR/BATT indicator dims or when the player stops operating. Replace all batteries with new ones.

SONY

Radio Cassette- Corder

Operating Instructions

CFS-777S

Sony Corporation ©1997
Printed in Indonesia

3-861-259-11(1)

WARNING

To prevent fire or shock hazard, do not expose the player to rain or moisture. To avoid electrical shock, do not open the cabinet. Refer servicing to qualified personnel only.

Do not install the appliance in a confined space, such as a bookcase or built-in cabinet.

The FUNCTION selector is located at the front. When you turn on the player, the OPR/BATT indicator lights up.

Precautions

On safety/power sources

- Should any solid object or liquid fall into the player, unplug the player, and have it checked by qualified personnel before operating it any further.
- For AC operation, check that the player's operating voltage is identical with your local power supply (see "Specifications") and use the supplied mains lead; do not use any other type. The voltage selector is located at the rear of the player.
- The player is not disconnected from the AC power source (mains) as long as it is connected to the wall outlet, even if the player itself has been turned off.
- For battery operation, use eight R20 (size D) batteries.
- When the batteries are not to be used, remove them to avoid damage that can be caused by battery leakage or corrosion.
- The nameplate indicating operating voltage, power consumption, etc. is located at the rear.

On placement/operation

- Do not leave the player in a location near heat sources, or in a place subject to direct sunlight, excessive dust or mechanical shock.
- Do not place anything within 10 mm of the side of the cabinet. The ventilation holes must be unobstructed for the player to operate properly and to prolong the life of its components.
- Since a strong magnet is used for the speakers, keep personal credit cards using magnetic coding or spring-wound watches away from the player to prevent possible damage from the magnet.
- If the player has not been used for a long time, set it in the playback mode to warm it up for a few minutes before inserting a cassette.

If you have questions or problems concerning your player, please consult your nearest Sony dealer.

Troubleshooting

There is no audio.

- Connect the mains lead securely.
- Insert the batteries properly.
- Replace all batteries if they are weak.
- Unplug the headphones.
- Adjust the volume.
- Set FUNCTION to the position you want to operate.

Cassette cannot be inserted.

- Insert the cassette properly.

The ● REC button does not function.

- No cassette is in deck B.
- Make sure the safety tab on the cassette is in place.

Poor playback, recording or erasing quality.

- Dirty heads. Clean the unit (as shown) with a cotton swab slightly moistened with cleaning fluid or alcohol.
- Demagnetize the heads and all metal parts in the tape path with a commercially available tape head demagnetizer.

Deck A

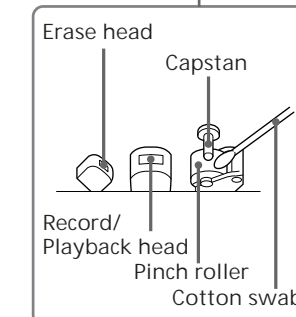
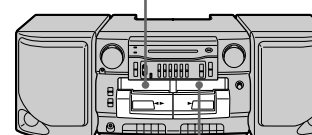
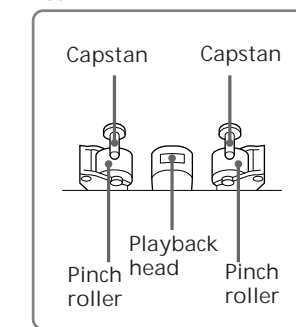

Deck B

Specifications

- Frequency range
FM: Saudi Arabia: 87.6-107MHz/Other countries: 87.6-108MHz
MW: 530-1,605kHz/SW1: 2.3-7MHz/SW2: 7-22MHz
- IF FM: 10.7MHz MW/SW: 455kHz
- Aerials FM/SW: Telescopic MW: Built-in ferrite bar
- Recording system 4-track, 2-channel stereo
- Frequency response 80-12,500Hz
- Speakers Full range: 10cm (4 inches) dia., cone type/Tweeter: 5 cm (2 inches) dia.
- Input MIX MIC jack (minijack), sensitivity 3.9 mV for low impedance microphone CD/TV LINE IN jacks (phono jacks), sensitivity 0.43 V, input impedance 50 kilohms
- Output Headphones jack (stereo minijack), for 16-68 ohms impedance headphones
- Maximum Power output 12W + 12W

- Battery life
FM Recording: Sony R20P: Approx. 5 hours/Sony LR20 alkaline: Approx. 12 hours
Playback: Sony R20P: Approx. 2 hours/Sony LR20 alkaline: Approx. 5.5 hours
- Power requirements 110-120V/220-240 V AC selectable, 50/60Hz
12V DC, eight R20 (size D) batteries
- Power consumption AC 30W
- Dimensions Approx. 760 x 225 x 220mm (w/h/d) (30 x 8 7/8 x 8 3/4 inches) incl. projecting parts and controls, not incl. handle
- Mass Approx. 6.8kg (15 lb) incl. batteries
- Supplied accessory AC power cord (1)

Design and specifications are subject to change without notice.

Location of controls

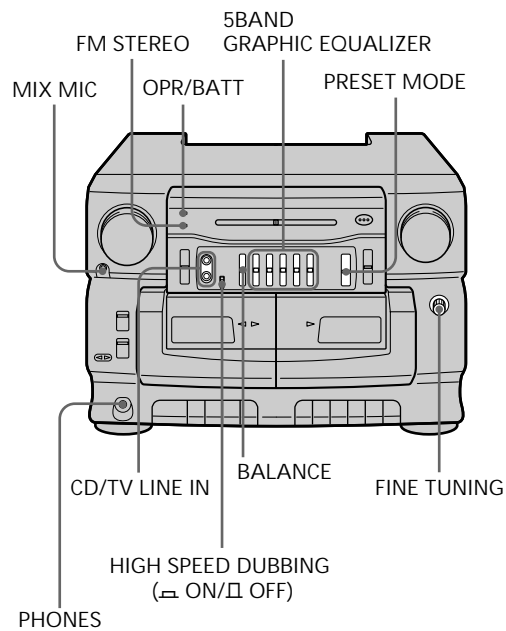
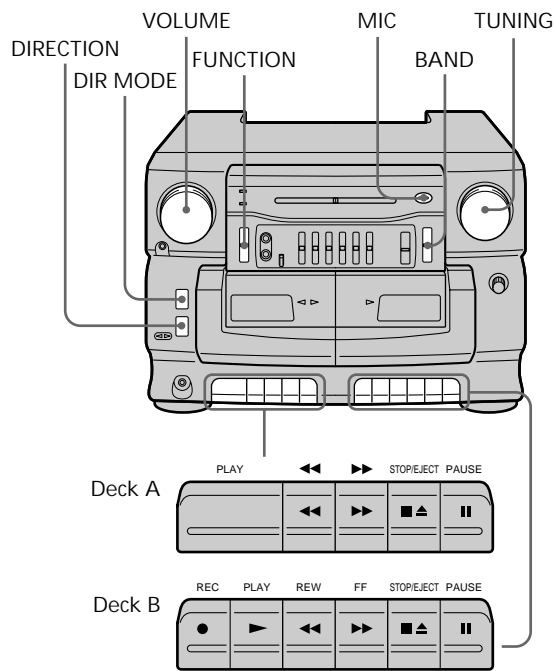

Listening to the radio

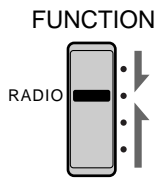
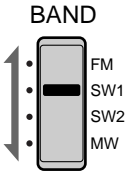
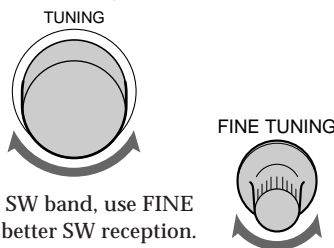
- 1 Set **FUNCTION** to **RADIO**.

- 2 Set **BAND** to the band you want.

- 3 Tune to the station you want.

To tune in an SW band, use **FINE TUNING** for better SW reception.

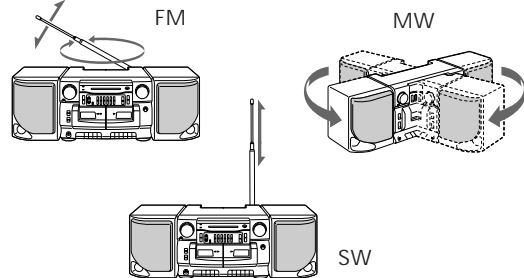
To turn off the radio
Set **FUNCTION** to **TAPE/RADIO OFF**.

To improve broadcast reception
Reorient the aerial for FM. Reorient the player itself for MW. For SW, pull the aerial vertically.



- Tips
- To listen through headphones, connect the headphones to the **PHONES** jack.
 - For best results, move the player away from a TV.

Use TYPE I (normal) tape only.

Playing a tape

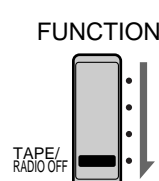
- 1 Set **FUNCTION** to **TAPE/RADIO OFF**.

- 2 Insert a recorded tape into deck A or B.

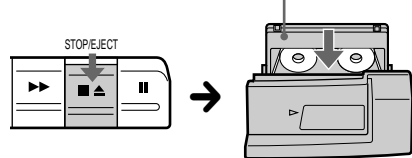
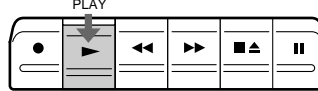
With the side you want to play facing forward.

- 3 Press **▶ PLAY**.

To	Press
Stop recording	■▲
Stop playback	■▲
Fast-forward or rewind the tape	▶▶ / ◀◀
Pause playback	

- Tips
- **DIRECTION** ◀/▶ (reverse/forward) indicators show the playback side during playback: **FWD** ▶ (forward side), or **REV** ◀ (reverse side)(deck A only).
 - To select the direction of the tape, set **DIR MODE** to ◀▶ for both sides repeatedly, or ▶◀ for both sides (from the front side to reverse side only). If play begins from the reverse side, the tape stops at the end of that side (deck A only).
 - To switch playback to the opposite side, press down **DIRECTION** once (deck A only).
 - To play tapes in both decks successively, press **PLAY** on deck B and then press **PLAY** and **||** on deck A at the same time. When the tape ends on deck B, the playback starts automatically on deck A.
 - When you play both decks, you will hear only deck B.

Note
Do not press ▶▶, ◀◀ or **PLAY** on the other deck during playback as this causes excessive wow and flutter.

Use TYPE I (normal) tape only.

Recording (deck B)

- 1 To record from the radio
Tune to the station you want.
To record from the built-in microphone
Set **FUNCTION** to **TAPE/RADIO OFF**.
- 2 Insert a blank tape into deck B.

With the side you want to record on facing forward.

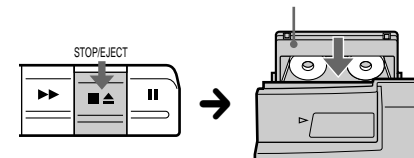
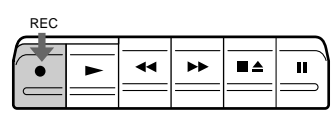
- 3 Press **● REC** on deck B.

To	Press
Stop recording	■▲
Pause recording	

When the tape ends, the recording stops.
Press this button again to resume recording.

- Tips
- For best results, use the AC power source.
 - Adjusting the volume or the audio emphasis will not affect the recording level.
 - To erase a recording, disconnect the audio source if connected to the **CD/TV LINE IN** jack. Set **FUNCTION** to **CD/TV LINE IN** and press **● REC**.

- Notes
- While recording from the built-in microphone, you cannot monitor the sound through the headphones.
 - When you connect the microphone to the **MIX MIC** jack, you cannot record from the built-in microphone.
 - Do not press ▶▶, ◀◀ or **PLAY** on deck A during recording as this causes excessive wow and flutter.

- Notes on cassettes
- Break off the cassette tab from side A or B to prevent accidental recording. If you want to reuse the tape for recording, cover the tab hole with adhesive tape.

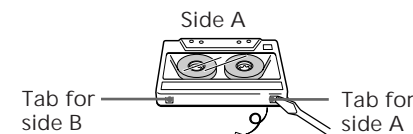



- The use of cassettes with more than 90 minutes of play time is not recommended except for long, continuous recording or playback.

Use TYPE I (normal) tape only.

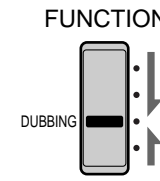
Dubbing (deck A to B)

- 1 Set **FUNCTION** to **DUBBING**.

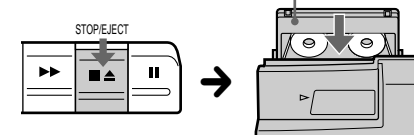
- 2 To dub at high speed
Press **HIGH SPEED DUBBING** to **ON**.
To dub at normal speed
Press **HIGH SPEED DUBBING** to **OFF**.
- 3 Insert a recorded tape into deck A, and a blank tape into deck B.

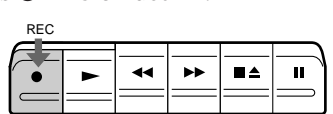
With the side you want to record on facing forward.

- 4 Press **|| PAUSE** and then press **▶ PLAY** on deck A.

- 5 Press **● REC** on deck B.

To stop dubbing
Press **■▲** on deck A and B.

- Tips
- For best results, use the AC power source.
 - Do not set the **FUNCTION** during dubbing as this causes excessive wow and flutter.
 - To dub at high speed, press **HIGH SPEED DUBBING** (ON) before you start dubbing. Do not press **HIGH SPEED DUBBING** during dubbing as this causes excessive wow and flutter.
 - Adjusting the volume or the audio emphasis will not affect the recording level.
 - When the tape in deck A ends first, deck B will also stop recording. When the tape in deck B ends first, deck A plays on as set with the **DIR MODE** switch.