

Home Theater Active Speaker System

Operating Instructions

SAVA-27

WARNING

To prevent fire or shock hazard, do not expose the unit to rain or moisture.

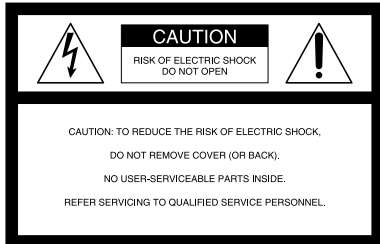

This symbol is intended to alert the user to the presence of uninsulated “dangerous voltage” within the product’s enclosure that may be of sufficient magnitude to constitute a risk of electric shock to persons.



This symbol is intended to alert the user to the presence of important operating and maintenance (servicing) instructions in the literature accompanying the appliance.

IMPORTANT

This equipment has been tested and found to comply with the limits for a Class B digital device, pursuant to Part 15 of the FCC Rules.

These limits are designed to provide reasonable protection against harmful interference in a residential installation. This equipment generates, uses, and can radiate radio frequency energy and, if not installed and used in accordance with the instructions, may cause harmful interference to radio communications.

However, there is no guarantee that interference will not occur in a particular installation. If this equipment does cause harmful interference to radio or television reception, which can be determined by turning the equipment off and on, the user is encouraged to try to correct the interference by one or more of the following measures:

- Reorient or relocate the receiving antenna.

- Increase the separation between the equipment and receiver.
- Connect the equipment into an outlet on a circuit different from that to which the receiver is connected.
- Consult the dealer or an experienced radio/TV technician for help.

CAUTION

You are cautioned that any changes or modifications not expressly approved in this manual could void your authority to operate this equipment.

Do not install the appliance in a confined space, such as a bookcase or built-in cabinet.

Owner’s record

The model and serial numbers are located on the rear of the unit. Record the serial number in the space provided below. Refer to them whenever you call upon your Sony dealer regarding this product.

Model No. SAVA-27

Serial No. _____

For the customers in Canada

CAUTION

TO PREVENT ELECTRIC SHOCK, DO NOT USE THIS POLARIZED AC PLUG WITH AN EXTENSION CORD, RECEPTACLE OR OTHER OUTLET UNLESS THE BLADES CAN BE FULLY INSERTED TO PREVENT BLADE EXPOSURE.

Precautions

On safety

- Should any solid object or liquid fall into the cabinet, unplug the speaker system and have it checked by qualified personnel before operating it any further.

On power sources

- AC power cord must be changed only at the qualified service shop.
- Before operating the speakers, check that the operating voltage is identical with your local power supply. The operating voltage is indicated on the nameplate on the rear of the speakers.

- The speakers are not disconnected from the AC power source (mains) as long as they are connected to the wall outlet, even if the speakers themselves have been turned off.
- If you are not going to use the speakers for a long time, be sure to disconnect the speakers from the wall outlet. To disconnect the AC power cord, grasp the plug itself; never pull the cord.
- One blade of the plug is wider than the other for the purpose of safety and will fit into the wall outlet only one way. If you are unable to insert the plug fully into the outlet, contact your dealer.

On placement

- Do not install the appliance in a confined space, such as a bookcase or built-in cabinet.
- Do not place the speakers near heat sources, or in a place subject to direct sunlight, excessive dust or mechanical shock.
- Good ventilation is essential to prevent internal heat buildup. Place the speakers in a location with adequate air circulation, and in a way that does not block the rear ventilation holes.

On cleaning

- Clean the cabinet, panel and controls with a soft cloth slightly moistened with a mild detergent solution. Do not use any type of abrasive pad, scouring powder or solvent such as alcohol or benzine.

If you have any question or problem concerning your speaker system, please consult your nearest Sony dealer.

Welcome!

Thank you for purchasing a Sony speaker system.

The SAVA-27 is an active home theater speaker system incorporating a Dolby Pro Logic decoder and super woofer speakers. You can enjoy five different types of surround sound, accommodating a variety of program sources, with a simple setup.

About This Manual

Before operating the unit, please read this manual thoroughly and retain it for future reference.

The instructions in this manual describe the controls on the left speaker. You can also use the controls on the remote if they have the same or similar names as those on the left speaker.

- The following icons are used in this manual:



Indicates that you can use the remote to do the task.



Indicates hints and tips for making the task easier.

This speaker system incorporates the Dolby Pro Logic Surround System.*

* Manufactured under license from Dolby Laboratories Licensing Corporation. DOLBY, the double-D symbol  and "PRO LOGIC" are trademarks of Dolby Laboratories Licensing Corporation.

TABLE OF CONTENTS

Getting Started

- Unpacking 4
 - Speaker System Hookups 5
 - Audio Component Hookups 7
 - Choosing the Best Location 8
 - Turning the Speaker Systems On and Off 9
-

Home Theater Operations

- Enjoying Surround Sound 10
 - Adjusting the Surround Sound 11
 - Adjusting the Sound 12
 - Adjusting the Volume with the Sony TV Remote 12
 - Using an External Center Speaker 13
-

Additional Information

- Troubleshooting 14
 - Specifications 14
 - Glossary 15
-

Index Back cover

Unpacking

Check that you received the following items with your speaker system:

- Rear speakers SS-SR171 (2)
- Front L/R speaker connecting cord, 3.5 m (1)
- Rear speaker connecting cord, 10 m (2)
- Audio connecting cord, 1.5 m (1)
- Remote commander (remote) RM-J27 (1)
- Sony SUM-3 (NS) batteries (2)
- Speaker bases (2)
- Screws (8)
- SCART adaptor (1) (for European model only)

Inserting batteries into the remote

Insert two size AA (R6) batteries with the + and – on the battery compartment. When using the remote, point it at the remote sensor  on the front speaker (left).

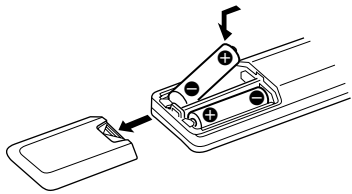

When to replace batteries

Under normal use, the batteries should last for about 6 months. When the remote no longer operates the speakers, replace both batteries with new ones.

Notes

- Do not leave the remote in an extremely hot or humid place.
- Do not use a new battery with an old one.
- Do not expose the remote sensor to direct sunlight or lighting apparatuses. Doing so may cause a malfunction.
- If you do not use the remote for an extended period of time, remove the batteries to avoid possible damage from battery leakage and corrosion.

Installing the speaker bases

Be sure to install the supplied speaker bases before you use the speakers.

- 1** Use a screw driver to fasten the bases to the bottom of the speakers with the supplied wood screws.
- 2** Make sure the bases are securely attached and stand the speaker upright.

Speaker System Hookups

This section describes how to connect the speaker system and how to connect your TV or VCR to the speakers.

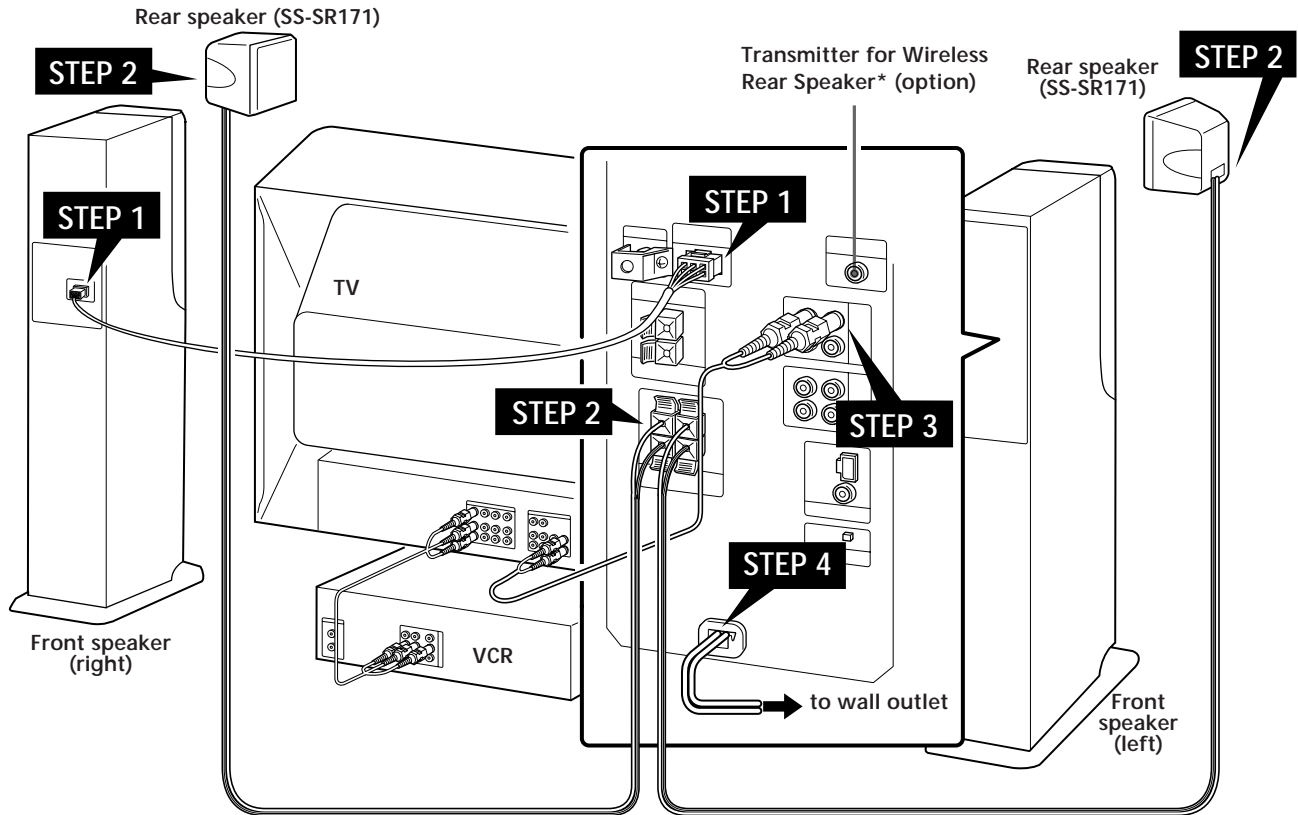

* If you use an SA-IF70 Wireless Speaker System (optional) for the rear speakers, connect the transmitter supplied with the SA-IF70 system to this connector. For details, refer to the Operating Instructions provided with the SA-IF70 system.

- 1 Twist the speaker cord coating and strip it from the end of the cords.

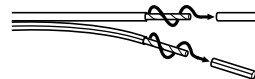

The arrow \Rightarrow indicates signal flow.

- 2 Insert the stripped wire into speaker terminals.

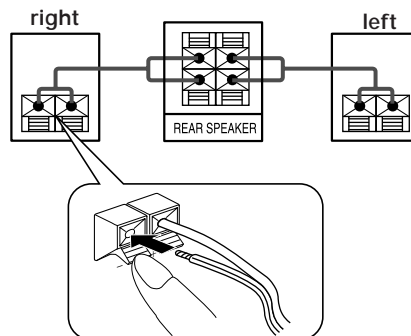

Be sure to connect matching speaker terminals (e.g. use the solid wire to connect + to +, and use the striped wire to connect - to -). If the connections are reversed (+ to -), the sound will be lack bass.

STEP 1 Connecting the front speakers

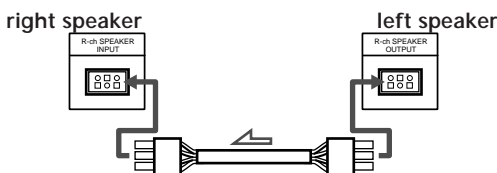

To disconnect, pull the connector out while pressing the release tab. Never pull the cord itself.

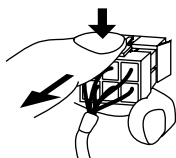

STEP 2 Connecting the rear speakers

Use the supplied speaker cord to connect the left and right rear speakers.

For customers in Canada

Use only the supplied SS-SR171 Rear Speakers for connection to the REAR SPEAKER connector.

(Continued)

STEP 3 Connecting your TV

If the audio and video output terminals on your TV and VCR are already connected, and your TV has stereo AUDIO OUT jacks, you can start enjoying surround sound simply by connecting the speaker system to your TV as shown below.

Important

If your TV has an on/off switch for its internal speaker, set this to off, and enjoy the sound from this speaker system. If not, set the volume on your TV to minimum.

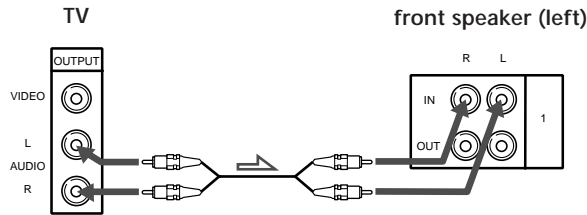

If you use AUDIO OUT jacks marked VARIABLE
After making the connection as shown above, turn up the volume on the TV. Use this speaker system's volume control for regular volume adjustment. Turning down the volume on the TV reduces the AUDIO OUT signal level and may cause a loss in sound quality and/or the auto-power off function (see page 9) to function.

For the best possible sound (or if your TV only has a monaural AUDIO OUT jack, or no AUDIO OUT jacks) Connect the speaker system directly to your VCR or cable box.

The following connections suppress noise from the TV and let you enjoy high quality sound.

1 Connect your VCR or cable box to the 1 IN jacks on the front speaker (left).

2 Connect your TV to the 1 OUT jacks on the front speaker (left). Make sure you use the 1 or 2 IN jacks that correspond to the VIDEO IN jack you are using on your TV set (i.e., VIDEO 1).

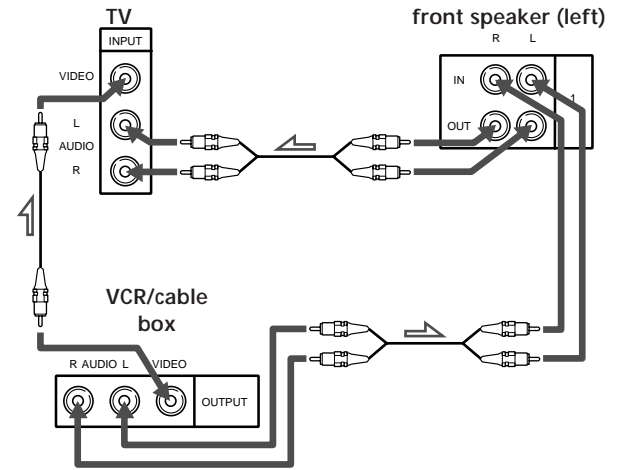

💡 If you have an additional VCR or LD player Connect it to the 2 IN jacks and connect the 2 OUT jacks to the AUDIO IN jack on the back of your TV.

Connecting the SCART adaptor (for European model only)

You can listen to the sound from the TV or VCR by connecting the audio signal from the TV or VCR to the front speaker (left).

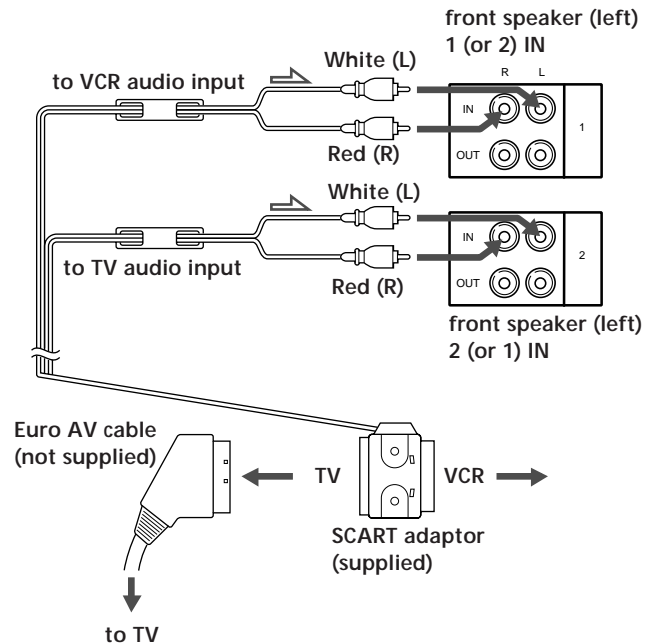

If you have a Sony XBR² series TV or Sony Projection TV equipped with a speaker switch
(For U.S.A. and Canadian customers only)

If your Sony XBR² series TV or Projection TV is compatible with SAVA series speakers, you can use the TV's menu and remote control functions to operate this speaker system.

For details, see the operating instructions supplied with your TV.

Be sure to connect the 1 IN jacks on the front speaker (left) to the TV's FIXED AUDIO OUTPUT jacks if you make this connection.

- 1 Use an optional CONTROL S cord to connect the CONTROL S TV IN jack on the front speaker (left) to the CONTROL S OUT jack on the back of the TV.

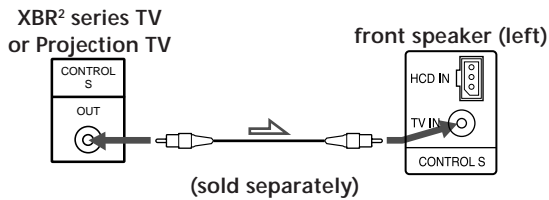

- 2 Follow the instructions supplied with your TV to set it to operate this speaker system.

STEP 4 Connecting the AC power cords

Connect the AC power cords from the front and rear speakers to wall outlets. The STANDBY indicator on the front speaker (left) lights red.

Audio Component Hookups

Since this speaker system incorporates its own internal amplifier and preamplifier, you can also connect an audio component, such as a CD player.

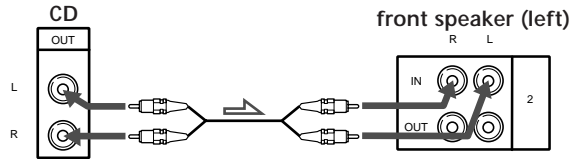

Note

Do not connect an amplified audio source. The combined amplification from the component and the speaker's internal amplifier may damage the speakers.

Hooking up the Sony HCD-VA550 (Optional Compact Disc Deck Receiver)

- 1 Connect the LINE OUT FIXED jacks on the HCD-VA550 to the 2 IN jacks on the front speaker (left). Be sure to connect them to the 2 IN jacks.

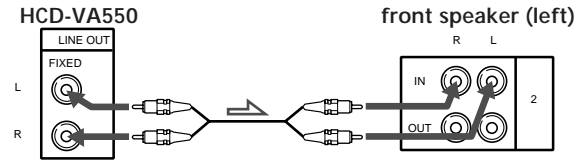

- 2 Connect the CONTROL S OUT jack on the HCD-VA550 component to the CONTROL S HCD IN jack on the front speaker (left).

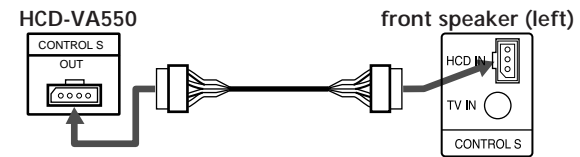

Notes

- You can control the speaker system SAVA-27 using the remote supplied with the HCD-VA550. In this case, point it at the remote sensor  on the speaker.
- While connecting the HCD-VA550 component to the speaker system with the CONTROL S cord, the auto power on/off function will not operate.

See the operating instructions supplied with your HCD-VA550 for details regarding its operation.

Choosing the Best Location

To obtain high sound quality and a proper sound image from the front speakers, place the speaker with the built-in operation panel to the left of your TV and the other to the right of your TV so that the center channel speaker angle towards the center of the room.

Front speakers

For the best central sound image, place the left and right speakers within 2.5 m (8 ft) of each other and equidistant from the TV.

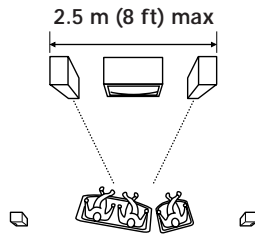

Rear speakers

Place the rear speakers so that they fire directly across at each other about 60 to 90 cm (2 to 3 ft) above the listener's ear.

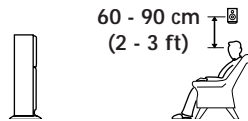

Built-in center speakers

The use of a center speaker is a key factor in obtaining a full surround effect when playing sources encoded with the Dolby Pro Logic Surround sound system. Center speakers in a movie theater make central sounds, such as dialogue, clearer and create a unified sound image.

The SAVA-27 incorporates a center speaker into the front speakers, which enables you to enjoy Dolby Pro Logic Surround sound.

The left and right front speakers are equipped with center channel speakers (see below) angled inwards at 15° to reproduce the center channel sounds.

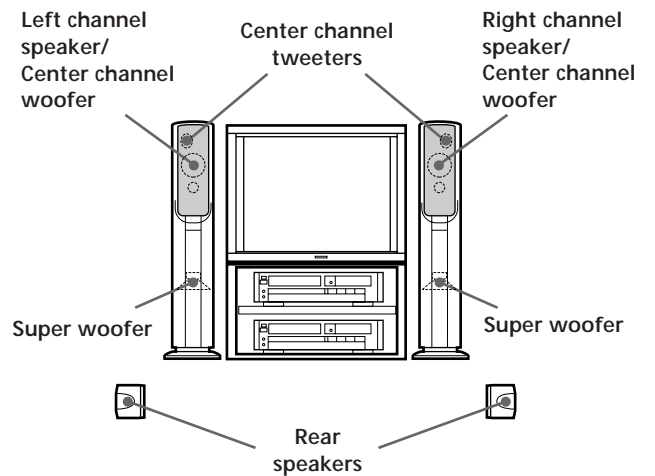

Turning the Speaker Systems On and Off

Press POWER on the remote or the front speaker (left). The front speaker ON/READY indicator lights green.

Power turns on and off automatically (Auto power on/off function)

You do not need to turn the speaker system on every time you use it. Three minutes after the sound source goes off (when you turn off the TV, or the currently playing video/laserdisc ends), the speakers turn off automatically and the ON/READY indicator turns red. The speakers turn themselves back on the next time you turn on the TV or start playback from the VCR.



If you press POWER when the speakers are on, the speakers switch to the standby mode (the ON/READY indicator goes off), and the auto power on/off function takes no effect. In this case, press POWER once more, and wait until the ON/READY indicator changes to red.

Note

If you are using this speaker system connected to an HCD-VA550, depending on the mode of operation the auto power on/off function may not operate.

Adjusting the contrast of the display window

You can dim the display, or turn it off, according to your preference.

Press DIMMER, on the remote, a few times until the display mode you desire appears.

The display returns to full brightness temporarily when you press one of the buttons on the remote.

Enjoying Surround Sound

You can take advantage of the speaker's surround sound simply by choosing a surround mode according to the type of program you are watching. This system is provided with five different surround modes:

PRO LOGIC (Dolby Pro Logic) surround mode
Reproduces superb theatre-like presence and surround effects from video software encoded with Dolby Surround.

THEATER surround mode
Creates a theater-like environment in your living room by adding the acoustic reflections of a theater to decoded Dolby Surround signals.

HALL surround mode
Reproduces the acoustics of a rectangular concert hall. Ideal for soft, acoustic sounds, or for giving an extra punch to debates and press conferences.

STADIUM surround mode
Provides a sense of presence similar to that of an open-air stadium. Ideal for maximum enjoyment of broadcasts of sporting events like football.

GAME surround mode
Obtains maximum audio impact from video game software.

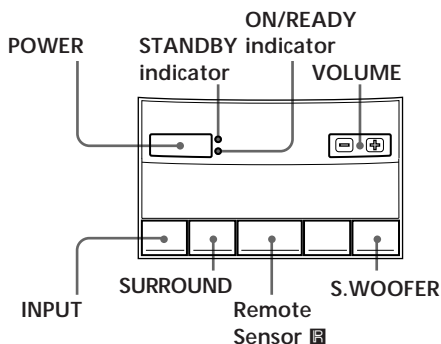
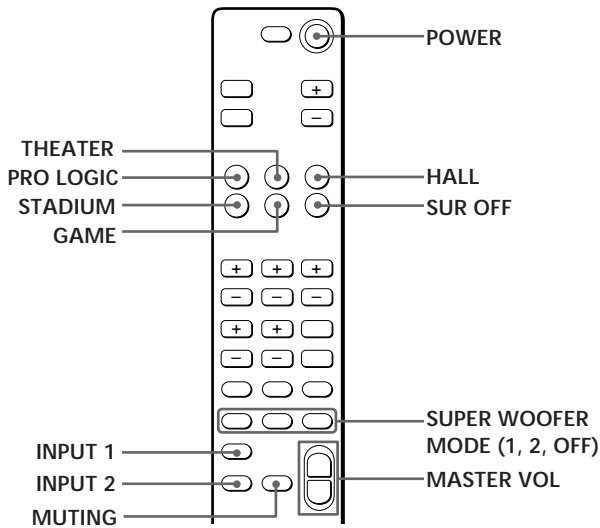

- 1 Press **POWER**.
The **ON/READY** indicator lights (green) and the speakers turn on.
- 2 Press **INPUT 1** or **2** on the remote or **INPUT** on the operation panel to select the program source. For example, if you connected your VCR to the 1 IN jacks, select **INPUT 1**.
The respective **INPUT** indicator lights up.
- 3 Start playback from the program source.
- 4 Press either **PRO LOGIC**, **THEATER**, **HALL**, **STADIUM**, or **GAME** on the remote, or **SURROUND** on the operation panel a few times, according to the program you want to enjoy. You can adjust the sound for each individual surround mode. (See "Adjusting the Surround Sound" on page 11 and "Adjusting the Sound" on page 12.)

program	PRO LOGIC	THEATER	HALL	STADIUM	GAME	SUR OFF
recent movies	●	●				
concerts, music			●	●		●
sports			●	●		●
old movies, monaural TV programs					●	●
video games					●	●
education, news						●

To listen without surround effects

Press **SUR OFF** on the remote, or press **SURROUND** on the operation panel a few times until **SUR OFF** is displayed.

- 5 Press **MASTER VOL (VOLUME)** to adjust the volume.

To mute the sound

Press **MUTING**.

To restore the sound, press **MUTING** again.

Note

Some videos and laser discs may use Dolby Pro Logic Surround sound even if it's not indicated on the package.

Adjusting the Surround Sound

Although this speaker system is factory preset to provide balanced surround sound without adjustment, you can adjust the volume of each speaker and the delay time to accommodate the conditions in your living room or your individual preference.

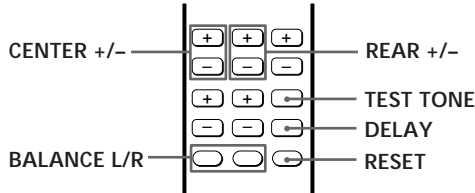

Adjusting the speaker volumes

The test tone feature lets you adjust the volume of the sound coming from each speaker to the same level, so that the surround sound will be even and natural.

Make the following adjustments from your listening position.

- 1 Select the PRO LOGIC or THEATER mode.
- 2 Press TEST TONE on the remote.
The test tone comes from each speaker in sequence:
- 3 Adjust the volume levels so that you hear the test tone from each speaker at the same volume level when you are in your listening position:

To adjust the level	press
between the right and left front speakers	BALANCE L or R
of the center speaker	CENTER + or -
of the rear speaker	REAR + or -

- 4 Press TEST TONE on the remote to turn off the test tone.
The adjustment levels for the selected mode are stored in memory.

To restore the center, rear, or balance levels to the factory setting

Press CENTER +/-, REAR +/-, or BALANCE L or R, then press RESET.

Note

Pressing buttons other than MASTER VOL, RESET, CENTER +/-, REAR +/-, or BALANCE L or R cancels the test tone.

Adjusting the delay time

By adjusting the delay time you can enhance the spatial characteristics of the sound to obtain a theater-like presence regardless of the size of your room. If the rear speakers are close to your listening position, choose a longer delay time.

You can adjust the settings individually for PRO LOGIC, THEATER, HALL, STADIUM, and GAME.

Note

The delay time cannot be adjusted in PRO LOGIC 3CH mode.

- 1 Select any surround mode.
- 2 Playback a program.
- 3 Press DELAY on the remote once to display the current delay time.
- 4 Press DELAY a few times to choose the delay time you prefer, either 15, 20, or 30 ms.
The factory setting is 20 ms.
The delay time adjustment for the selected mode is stored in memory.

To restore the delay time to the factory setting Press DELAY and then RESET.

Resetting an entire surround mode

Press the button for the surround mode you want to reset (i.e., HALL) and then press RESET while the name of the surround mode is being displayed. All of the adjustments in that mode, including the bass and treble, are reset to the factory settings.

Adjusting the Sound

Although this speaker system's sound quality is already adjusted, you can change the settings, as you like, for each surround mode individually. The following settings remain stored in their respective surround mode until you change them.

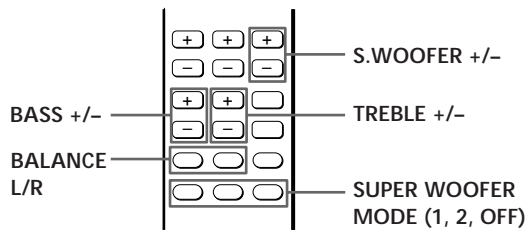

- 1 Playback a program and choose a surround mode.
- 2 Make the following sound adjustments according to your preference and/or the type of program you are watching.

To	press
select the super woofer mode	SUPER WOOFER MODE 1, 2 or OFF*
adjust the super woofer level	S.WOOFER + or -
adjust the bass level	BASS + or -
adjust the treble level	TREBLE + or -
adjust the balance	BALANCE L or R**

* SUPER WOOFER MODE 1 provides powerful bass sound ideal for movies. SUPER WOOFER MODE 2 is a more subtle effect designed for music.

** Since BALANCE L and R control sound from the front speakers, they have little effect on DOLBY PRO LOGIC when the source software has a high proportion of center-channel sound.

The sound adjustment is stored in the selected surround mode.

To restore the factory settings

- 1 Choose a surround mode.
- 2 Press RESET after pressing either SUPER WOOFER MODE 1, 2 or OFF, S.WOOFER +/-, BASS +/-, TREBLE +/-, or BALANCE L/R.

Adjusting the Volume with the Sony TV Remote

Set the VOLUME SYNCHRO switch on the front speaker (left) to ON. You can then adjust the volume with the TV remote supplied with your Sony television. In this case, set the TV internal speakers to "OFF."

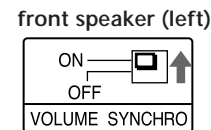

Note

This function only operates with a Sony TV. You cannot control the volume of this speaker system with a TV remote from another manufacturer.

In the following cases, set the VOLUME SYNCHRO switch to OFF

- When your television is made by Sony but you cannot switch the internal speakers off.
- When you do not wish to adjust the volume of this speaker system with the TV remote.

If your television is a Sony XBR² or Sony Projection TV

(For U.S.A. and Canadian customers only)

If your Sony XBR² series TV or Projection TV is compatible with the SAVA series speakers, you can make a setting on the TV so that you can control the speakers with the TV remote. Set the VOLUME SYNCHRO switch on the front speaker (left) to OFF. Set the TV internal speakers to "VA SPEAKER" or "SAVA SP." (See the operating instructions supplied with your model.) Using the supplied TV remote, you can adjust the speaker volume, surround mode, and super woofer mode.

Using an External Center Speaker

Since this system incorporates a center speaker (see page 8), you don't have to connect a center speaker. However, it is possible to connect a center speaker, if you already have one, to the EXTERNAL CENTER SPEAKER terminals. Be sure to use a speaker with a 4 to 8 ohm impedance for the center speaker.

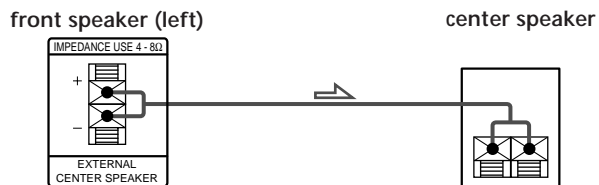

Use a screwdriver and remove the screw holding the CENTER SPEAKER button cover in place. Then depress the CENTER SPEAKER button. This turns off the internal center speaker and directs the center channel signal to the EXTERNAL CENTER SPEAKER terminals.

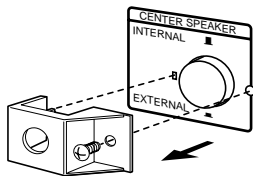

Connecting an external center speaker lets you choose from 4 different Dolby Pro Logic Surround center modes: NORMAL, WIDE, 3 CH (3 Channel logic), or PHANTOM. Use the NORMAL or WIDE mode. For details on Dolby Pro Logic Surround sound, see page 15.

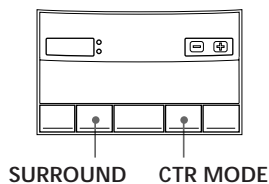

- 1 Press SURROUND on the front speaker (left) to choose PRO LOGIC. ("PRO LOGIC EXTERNAL" appears in the display instead of "PRO LOGIC" when you press PRO LOGIC on the remote.)
- 2 Press CTR MODE on the front speaker (left) a few times until the center mode you want appears in the display.

- 3 Adjust the speaker volumes and delay time, if necessary, by referring to page 11.

Troubleshooting

If you experience any of the following difficulties while using the speakers, use this troubleshooting guide to help you remedy the problem. Should any problem persist, consult your nearest Sony dealer.

There's no sound from any of the speakers.

- ➔ Check that components are connected securely to the speakers.
- ➔ Make sure you selected the correct input (1 or 2).
- ➔ Press **MUTING** to cancel the muting function.
- ➔ Press **MASTER VOL +** to turn up the volume.
- ➔ Turn up the volume on the TV to increase the output level when using the TV's **VARIABLE AUDIO OUTPUT** terminals.

No sound or only a very low sound level is heard from the rear speakers.

- ➔ Surround sound is turned off.
- ➔ Adjust the volume of the rear speakers (see page 11).
- ➔ Check the sound image balance with **TEST TONE** (see page 11).

There's no sound from the center speaker.

- ➔ Make sure you selected the **PRO LOGIC** surround mode.
- ➔ No center speaker is connected, but the **CENTER SPEAKER** button on the rear panel is set to **EXTERNAL**.
- ➔ You connected an external center speaker, but the **Dolby Pro Logic Surround** center mode is set to **PHANTOM**.
- ➔ You connected an external center speaker, but the **CENTER SPEAKER** button on the rear panel is set to **INTERNAL**.

Severe hum or noise is heard.

- ➔ Move the connecting cord away from any transformers or motors and least 3 meters (10 feet) from any fluorescent lights.

- ➔ Connect the speakers to your VCR or cable box instead of to your TV (see page 6).

Remote operations cannot be performed.

- ➔ Point the remote towards the remote sensor on the front speaker (left).
- ➔ Remove any obstructions between the remote and this system's front speaker (left).
- ➔ Replace the batteries in the remote.

The volume cannot be controlled with the TV remote.

- ➔ The **VOLUME SYNCHRO** switch on the rear panel is set to **OFF**.
- ➔ The speakers are connected to a TV not manufactured by Sony.

Specifications

Audio Power Specifications

For center and front full range speakers: with 8 ohm loads, both channels driven, from 150 Hz – 20 kHz; rated 20 watts per channel minimum RMS power, with no more than 0.9% total harmonic distortion from 250 milliwatts to rated output.

Amplifier section

Continuous RMS power output	Total 150 W
Center channel tweeter	32 W (8 ohms at 10 kHz, 9% THD)
Front channel/Center channel woofer	27 W + 27 W (8 ohms at 1 kHz, 9 % THD)
Super woofer	32 W (8 ohms at 60 Hz, 9 % THD)
Rear	32 W (8 ohms at 1 kHz, 9 % THD)
Input sensitivity/Impedance	
1/2 CONTROL S (TV) (for U.S.A. and Canadian customers only)	650 mV, 50 kohms Only for Sony XBR ² and Sony Projection TV
(HCD)	Only for Sony HCD-VA550
Output	
1/2 External Center	450 mV, 1 kohms 32W (8 ohms at 1 kHz, 9 % THD), 4-8 ohms
Rear speaker	Accepts only supplied SS-SR171
Wireless rear speaker	Accepts only Sony models
R-ch speaker	Accepts only SAVA-27 R-ch speaker with supplied exclusive speaker cord
Tone control	
Front/Center	Bass: ±10 dB at 100 Hz Treble: ±10 dB at 10 kHz

Speaker section

Type	
Front	Bass reflex type
Center	Bass reflex type
Super woofer	SAW type
Rear	Bass reflex type

Speaker unit

Center tweeter:	5 cm cone type (×2)
Center woofer/ Front full range:	10 cm cone type (×2)
Super woofer:	13 cm cone type (×2)
Rear full range:	8 cm cone type (×2)

General

Power requirement

U.S.A., Canada, and Central south America: 120 V AC, 60 Hz
 Other models: 220-230 V AC, 50/60 Hz

Power consumption

USA: 95 W
 Canada: 105 W
 Others: 100 W

Dimensions

Front/Center: Approx. 270 x 1045 x 370 mm (10 1/2 x 41 x 14 1/2 inches) (w/h/d, including speaker base)
 Rear: Approx. 110 x 160 x 140 mm (4 5/16 x 6 5/16 x 5 1/2 inches) (w/h/d)

Mass

Front speaker (L): 17.5 kg (38 lb)
 Front speaker (R): 14 kg (31 lb)
 Rear speaker : 750 g (2 lb) (for one speaker)

Supplied accessories

- Rear speakers SS-SR171 (2)
- Front L/R speaker connecting cord, 3.5 m (1)
- Rear speaker connecting cord, 10 m (2)
- Audio connecting cord, 1.5 m (1)
- Remote commander RM-J27 (1)
- Sony SUM-3 (NS) batteries (2)
- Speaker bases (2)
- Screws (8)
- SCART adaptor (1) (European model only)

Optional

Wireless speaker system SA-IF70

Design and specifications are subject to change without notice.

Glossary

Center mode

Speaker setting to enhance the Dolby Pro Logic Surround mode. Select one of the following four center modes according to your speaker system.

• **NORMAL mode**

Select NORMAL mode if you connect a small sized center speaker to this speaker system. Since a small speaker cannot produce enough bass, the bass sound of the center channel is output from the front speakers.

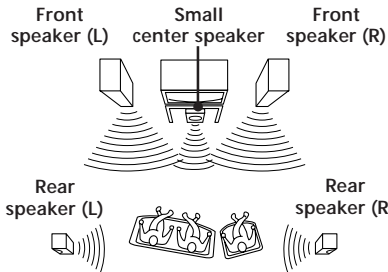

• **WIDE mode**

Select WIDE mode if you connect a center speaker equivalent to the two front speakers. With the WIDE mode, you can take full advantage of Dolby Surround sound.

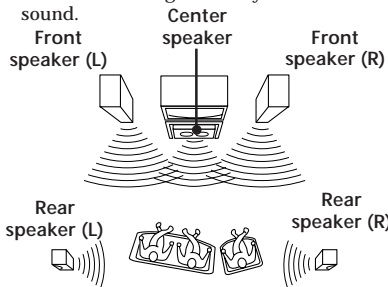

The test tone is output as shown on page 11.

• **3 CH LOGIC mode**

Select 3 CH LOGIC mode if you do not want to use the rear speakers to output sound. The sound of the rear channel is output from the front speakers to let you experience some of the surround sound without using rear speakers.

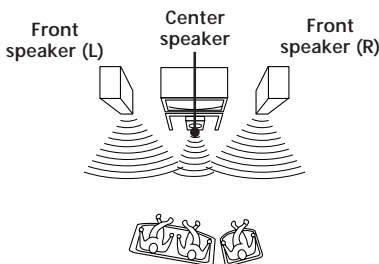

The test tone is output:



• **PHANTOM mode**

Select PHANTOM mode if you do not want to use the center speaker to output sound. The sound of the center channel is output from the front speakers.

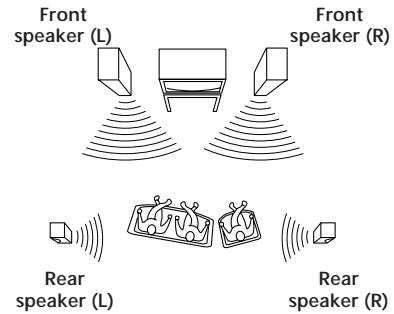

The test tone is output:

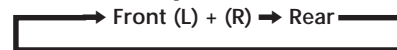

Delay time

Time lag between the surround sound output from front speakers and rear speakers. By adjusting the delay time of the rear speakers, you can obtain the feeling of presence. Make the delay time longer when you have placed the rear speakers in a small room or close to your listening position, and make it shorter when you have placed them in a large room or apart from your listening position.

Dolby Pro Logic Surround

Decoding system of Dolby Surround sound standardized in TV programs and movies. Compared with the former Dolby Surround system, Dolby Pro Logic Surround improves sound image by using four separate channels: off-screen audio effects, on-screen dialog, left-to-right panning, and music. These channels manipulate the sound to be heard and enhance the action as it happens on the screen. To take advantage of Dolby Pro Logic, you should have at least one pair of rear speakers and/or one center speaker. You also need to select the appropriate center mode to enjoy a full effect.

Dolby Surround

Encoding and decoding system of Dolby Surround sound for consumer use. Dolby Surround decodes the extra channels on the Dolby Surround-encoded sound tracks of movie videos and TV programs and produces sound effects and echoes that make the action seem to envelop you.

Index**A, B**

- Adjusting
 - bass 12
 - delay time 11
 - speaker volume 11
 - super woofer level 12
 - treble 12
 - volume 10
- Audio component hookups 7

C

- Center mode 13, 15
 - NORMAL mode 13, 15
 - PHANTOM mode 13, 15
 - 3 CH LOGIC mode 13, 15
 - WIDE mode 13, 15
- Connecting. See Hookups

D

- Delay time 11, 15
- Dolby Pro Logic Surround 8, 10, 15
 - center mode 13, 15
- Dolby Surround sound 15

E, F, G

- External center speaker 13

H, I, J, K, L, M

- Hookups
 - audio components 7
 - AC power cords 7
 - speakers 5
 - TV/VCRs 6

N, O

- NORMAL mode 13, 15

P, Q

- PHANTOM mode 13, 15

R

- Remote 4, 10, 11, 12

S

- Speakers
 - connection 5
 - placement 8
- Speaker volume 11
- Surround sound 10, 11, 12

T

- Test tone 11
- 3 CH LOGIC mode 13, 15
- Troubleshooting 14
- TV/VCR hookups 6

U

- Unpacking 4

V

- VOLUME SYNCHRO 12

W, X, Y, Z

- WIDE mode 13, 15