

Video Cassette Player

Operating Instructions



Hi-Fi

KARAOKE

SLV-KH7ME/PS/SV

WARNING

To prevent fire or shock hazard, do not expose the unit to rain or moisture.

To avoid electrical shock, do not open the cabinet. Refer servicing to qualified personnel only.

The mains lead must only be changed at a qualified service shop.

Precautions

Safety

- This unit operates on 110 – 240 V AC, 50/60 Hz. Check that the unit's operating voltage is identical with your local power supply.
- If anything falls into the cabinet, unplug the unit and have it checked by qualified personnel before operating it any further.
- The unit is not disconnected from the mains as long as it is connected to the mains, even if the unit itself has been turned off.
- Unplug the unit from the mains if you do not intend to use it for an extended period of time. To disconnect the lead, pull it out by the plug, never by the lead.

Installing

- Allow adequate air circulation to prevent internal heat buildup.
- Do not place the unit on surfaces (rugs, blankets, etc.) or near materials (curtains, draperies) that may block the ventilation slots.
- Do not install the unit near heat sources such as radiators or air ducts, or in a place subject to direct sunlight, excessive dust, mechanical vibration or shock.
- Do not install the unit in an inclined position. It is designed to be operated in a horizontal position only.
- Keep the unit and cassettes away from equipment with strong magnets, such as microwave ovens or large loudspeakers.
- Do not place heavy objects on the unit.
- If the unit is brought directly from a cold to a warm location, moisture may condense inside the unit and cause damage to the video head and tape. When you first install the unit, or when you move it from a cold to a warm location, wait for about one hour before operating the unit.

Caution

Television programmes, films, video tapes and other materials may be copyrighted.

Unauthorized recording of such material may be contrary to the provisions of the copyright laws. Also, use of this recorder with cable television transmission may require authorization from the cable television transmitter and/or programme owner.

Compatible colour systems

This unit is designed to record and play back using the PAL (B/G and D/K), MESECAM (B/G and D/K), and NTSC colour systems. Recording of video sources based on other colour systems cannot be guaranteed.

Table of contents

Getting Started

- 4 Step 1: Unpacking
- 5 Step 2: Setting up the remote commander
- 6 Step 3: Connecting the unit
- 9 Step 4: Tuning your TV to the unit
- 11 Step 5: Selecting a language

Basic Operations

- 12 Playing a tape
- 16 Recording TV programmes

Additional Operations

- 19 Playing/searching at various speeds
- 21 Recording TV programmes using the easy timer
- 22 Karaoke sing-along
- 30 Searching with the AMS or index function
- 32 Enjoying the surround sound (Virtual Sound)
- 33 Adjusting the picture
- 34 Changing menu options

Editing

- 35 Connecting to a VCR or stereo system
- 36 Basic editing
- 37 Audio dubbing

Additional Information

- 40 Troubleshooting
- 42 Specifications
- 43 Index to parts and controls
- back cover
- Index

Step 1

Unpacking

Check that you have received the following items with the unit:

- Remote commander

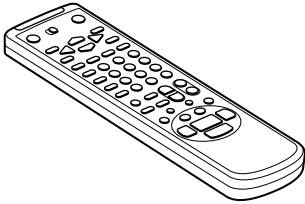

- Audio/video cable (3-phono to 3-phono)

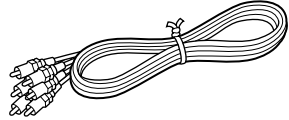

- R6 (size AA) batteries

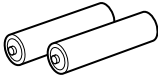

- Microphone

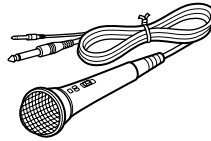

- Aerial cable

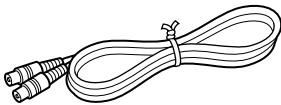

- Plug adaptor (SLV-KH7ME only)

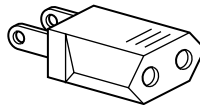

Checking your model name

The instructions in this manual are for the 3 models : SLV-KH7ME, KH7PS and KH7SV. Check your model number by looking at the rear panel of your unit. The SLV-KH7ME is the model used for illustration purposes. Any difference in operation is clearly indicated in the text, for example, "SLV-KH7ME only."

Step 2

Setting up the remote commander

Inserting the batteries

Insert two R6 (size AA) batteries by matching the + and - on the batteries to the diagram inside the battery compartment.

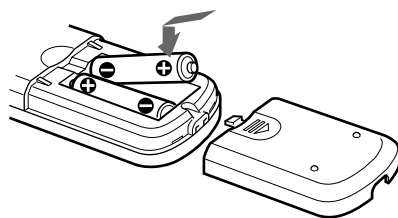

Using the remote commander

You can use this remote commander to operate this unit and a Sony TV. Buttons on the remote commander marked with a dot (•) can be used to operate your Sony TV.

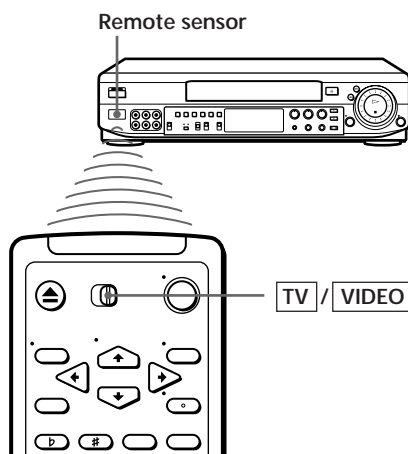

To operate	Set TV / VIDEO to
the unit	VIDEO and point at the remote sensor on the unit
a Sony TV	TV and point at the remote sensor on the TV

Notes

- The TV/VIDEO button selects an input source of the TV from aerial in or line in. The button does not control this unit.
- With normal use, the batteries should last about three to six months.
- If you do not use the remote commander for an extended period of time, remove the batteries to avoid possible damage from battery leakage.
- Do not use a new battery with an old one.
- Do not mix different types of batteries.

Step 3

Connecting the unit

To a TV that has phono type audio/video input jacks

This connection improves picture and sound quality and is necessary if you want to use the Trinitron TV Synchro Play function. If your TV does not have audio/video input jacks, skip this step and go to page 8.

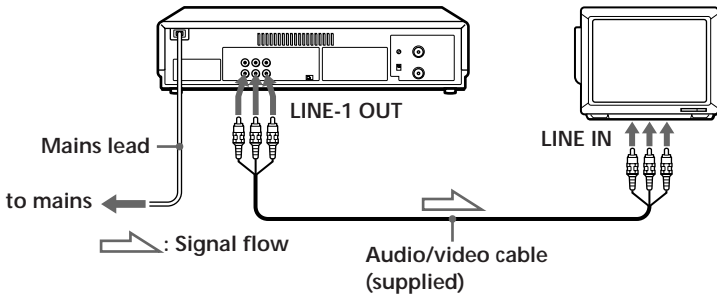

1

Connect LINE-1 OUT of the unit to the line input jacks of your TV using the supplied audio/video cable.

To use the Trinitron TV Synchro Play function, connect to the VIDEO IN 1 jacks if your TV has two or more inputs.

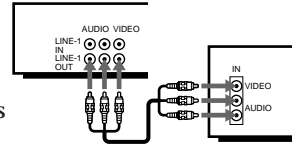

2

Connect the mains lead to the mains.

Additional connection

To a TV that has phono type audio/video output jacks

You can record a TV programme showing on a TV. Connect LINE-1 IN of the unit to the TV as shown on the right. For details on recording, see “Recording TV programmes” on page 16. When connecting the LINE-1 IN and LINE-1 OUT jacks on the unit to your TV at the same time, follow the procedure below to set up the unit (see page 34).

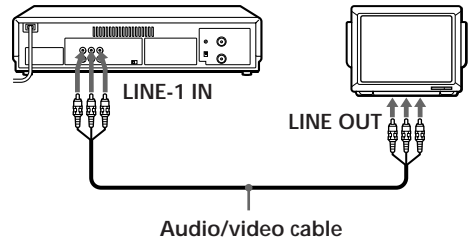

- 1 Press MENU.
- 2 Press CURSOR \uparrow/\downarrow to move the cursor (\blacktriangleright) to SET UP MENU and press EXECUTE.
- 3 Press CURSOR $\uparrow/\downarrow/\leftarrow/\rightarrow$ to move the cursor (\blacktriangleright) to CONNECT L1, then select TV.

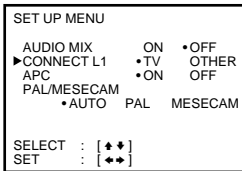

- 4 Press EXECUTE.

Note

- When you connect the LINE-1 IN jacks of the unit to other equipment, set CONNECT L1 to OTHER.

continued

Step 3 : Connecting the unit (continued)

To a TV that does not have audio/video input jacks

If you connect the unit to your TV using the audio/video cable, skip this step.

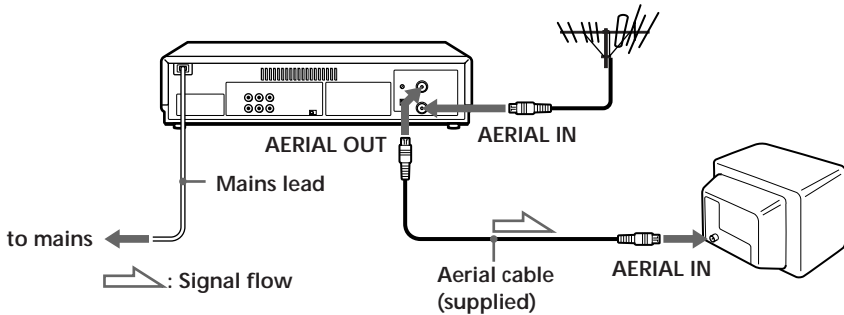

1

Disconnect the aerial cable from your TV and connect it to AERIAL IN on the rear panel of the unit.

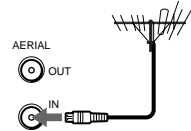

2

Connect AERIAL OUT of the unit and the aerial input of your TV using the supplied aerial cable.

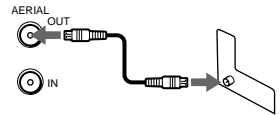

3

Connect the mains lead to the mains.

Additional connection

To a stereo system

You can improve sound quality by connecting a stereo system as shown on the right.

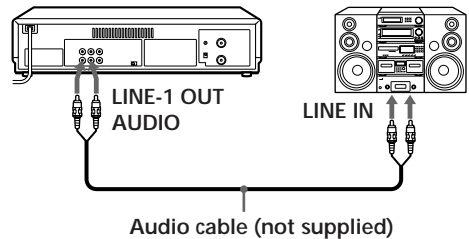

Step 4

Tuning your TV to the unit

If you have connected the unit to your TV using the audio/video cable, skip this step.

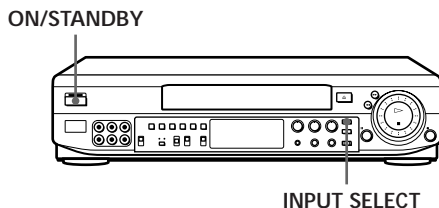

- 1**  Press ON/STANDBY to turn on the unit.

- 2**  Press INPUT SELECT until "L2" appears in the display window.

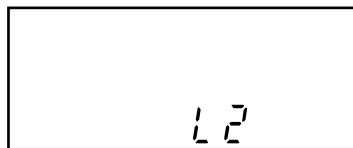

- 3** Turn on your TV and select a programme position for the video playback.
Choose a channel between UHF 30 and 39 on the TV, where there is no picture and no sound or only a steady rustling sound. This channel will now be referred to as the video channel.

- 4** Tune the TV so that a blue screen appears on the TV screen. Refer to your TV manual for tuning instructions.
You have now tuned your TV to the unit. From now on, whenever you want to play a tape, set the TV to the video channel.
If the blue screen does not appear clearly, see "To obtain a clear blue screen" on page 10.

continued

Step 4 : Tuning your TV to the unit (continued)

To obtain a clear blue screen

If the blue screen does not appear clearly in step 4 above, turn the RF-CH screw at the rear of the unit with a screw driver to a position where the TV clearly displays the blue screen.

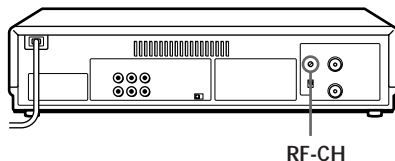

To select the TV system

For your TV to receive the correct signal from your unit, you must set the TV SYSTEM switch at the rear of the unit to either G (for system B/G) or K (for system D/K). If this switch is set to the wrong position, the sound will be distorted.

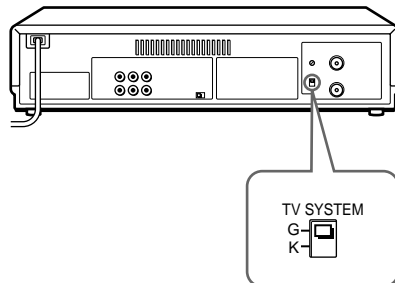

Step 5

Selecting a language

You can select the on-screen display language, English or Chinese.

Before you start...

- Turn on the unit and the TV.
- Set the TV to the video channel.

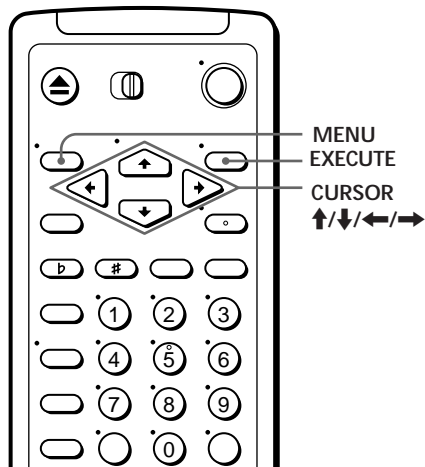

1

• MENU



Press MENU, then press CURSOR ↑/↓ to move the cursor (▶) to LANGUAGE and press EXECUTE.

• CURSOR



• EXECUTE



LANGUAGE / 语言

• ENGLISH
中文

SELECT : [◆◆]
END : [EXECUTE]

2

• CURSOR



Press CURSOR ↑/↓ to select the desired language.

LANGUAGE / 语言

ENGLISH
• 中文

选择 : [◆◆]
完毕 : [EXECUTE]

3

• EXECUTE



Press EXECUTE.

Playing a tape

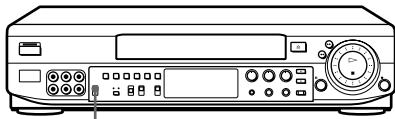

COLOR SYSTEM switch

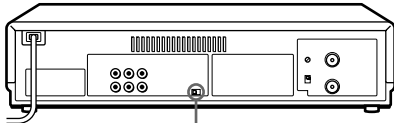

NTSC PB switch

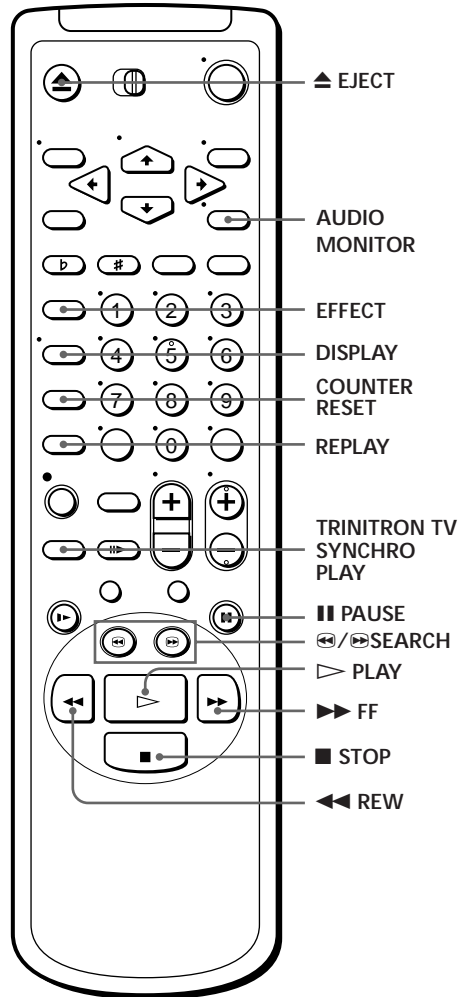

1 Turn on your TV and set it to the video channel.

2 Insert a tape.
The unit turns on and starts playing automatically if you insert a tape with its safety tab removed.

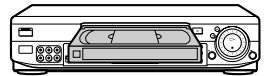

3 Press  PLAY.

When the tape reaches the end, it will rewind automatically.

Additional tasks

To	Press
Stop play	■ STOP
Pause play	PAUSE
Resume play after pause	PAUSE or ▷ PLAY
Search forward	▶▶ FF or 🔍 SEARCH during playback
Search backward	◀◀ REW or 🔍 SEARCH during playback
Fast-forward the tape	▶▶ FF during stop
Rewind the tape	◀◀ REW during stop
Eject the tape	▲ EJECT

To replay a recently watched scene

You can immediately rewind and playback the scene you want to watch again.

During playback, press REPLAY up to four times. The unit rewinds the tape 10 seconds for each press of the button, and restarts playback.

To set the colour system

If streaks appear during playback, set COLOR SYSTEM on the unit to conform to the system that the tape was recorded in. (Normally, set the switch to AUTO.)

If your tape was recorded in	Set COLOR SYSTEM to
PAL	PAL/MESECAM
NTSC	NTSC
MESECAM	PAL/MESECAM

To play an NTSC-recorded tape

Set NTSC PB at the rear of the unit according to the colour system of your TV.

If your TV is	Set NTSC PB to
PAL	ON PAL TV
NTSC 4.43	NTSC 4.43
NTSC 3.58	NTSC 3.58

continued

Playing a tape (continued)

To use the time counter

At the point on the tape that you want to find later, press COUNTER RESET. The counter in the display window resets to "0H00M00S." Search for the point afterwards by referring to the counter.

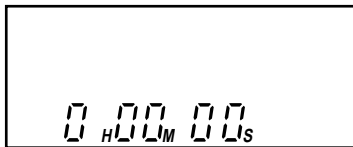

To display the counter on the TV screen, press DISPLAY.

To select the sound during playback

Press AUDIO MONITOR to select the sound you want.

Stereo programme

To listen to	On-screen display	Display window
Stereo	STEREO	L, R, STEREO
Left channel	LCH	L
Right channel	RCH	R
Standard sound*	No indicator	No indicator

* Usually the mixed sound of the left and right channels

Bilingual programme

To listen to	On-screen display	Display window
Main	LCH	L
Sub	RCH	R
Main and sub	STEREO	L, R, STEREO
Standard sound*	No indicator	No indicator

* Usually the main sound (monaural)

To check audio channel and sound level

You can check the audio channel and sound level visually with the indicators in the display window.

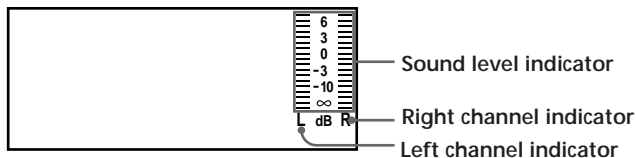

Notes

- When you play back a tape recorded in the PAL or MESECAM colour system, streaks may appear even if the COLOR SYSTEM switch is set to PAL/MESECAM. If so, select the colour system, PAL or MESECAM in the PAL/MESECAM option of the SET UP MENU. (For details, see page 34.)
- The counter resets to "0H00M00S" whenever a tape is reinserted.
- The counter stops counting when it comes to a portion with no recording.
- If a tape has portions recorded in both PAL and NTSC systems, the time counter reading will not be correct. This is due to the difference between the counting cycles of the two video systems.
- Depending on your TV, the following may occur while playing an NTSC-recorded tape:
 - the picture is black and white,
 - the picture shakes,
 - no picture appears on the TV screen,
 - black streaks appear horizontally on the TV screen,
 - the colour density increases or decreases.
- To play a tape in stereo, you must use the AUDIO OUT connections.
- When you play a tape recorded in monaural, the sound is heard in monaural regardless of the AUDIO MONITOR setting.
- If the AUDIO MONITOR button does not function, check that AUDIO MIX in the SET UP MENU is set to OFF.

Turning on the unit and TV, and starting playback automatically (Trinitron TV Synchro Play)

You can only use this function if your TV is made by Sony (Trinitron TV).

How to connect to use this function

Connect the unit and TV with the audio/video cable (see "To a TV that has phono type audio/video input jacks" on page 6.) Be sure to connect the audio/video cable to the VIDEO IN 1 jacks on the TV if the TV has two inputs or more. The TV must be placed where it will respond to the remote commander while you are pointing it at the unit.

Operation

Make sure that the TV's power is in standby mode.

Press TRINITRON TV SYNCHRO PLAY and hold the remote commander in place for about two seconds.

The unit and TV turn on, and the TV is set to the video channel. If there is a tape in the unit, playback starts automatically.

Notes

- If the Trinitron TV Synchro Play function does not work properly:
 - Wait a few moments, and press the button again.
 - Replace both of the batteries with new ones, and press the button again.
 Note that this function may not operate some Sony TVs because of the remote commander's signal limitations.
- Do not press TRINITRON TV SYNCHRO PLAY while playing back a video tape. If you do so, the TV's input source will momentarily switch to the TV's tuner.

Recording TV programmes

You can record TV programmes from your TV by connecting the TV to the unit's LINE-1 IN jacks.

Before you start...

- Connect the LINE-1 IN jacks of the unit to the audio/video output jacks of your TV (see "Additional connection" on page 7).
- Set CONNECT L1 to TV in the SET UP MENU (see page 7).

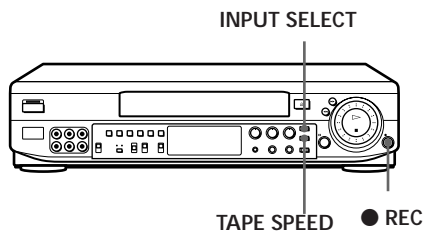

1 Turn on your TV and select the programme position you want to record on your TV.

2 Insert a tape with its safety tab in place.

3  Press INPUT SELECT to display "L1" in the display window.

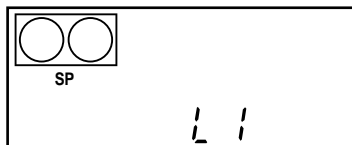

4  Press TAPE SPEED to select the tape speed, SP or LP.
LP provides recording time twice as long as SP, however, SP produces better picture and audio quality.

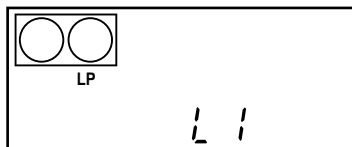

5  Press ● REC to start recording.

To stop recording
Press ■ STOP.

To record NTSC colour system programmes

NTSC colour signals can be recorded on this unit.

For tape speed, select SP or EP in step 4.

EP provides recording time three times as long as SP, however, SP produces better picture quality.

When playing back, the unit automatically detects the tape speed.

To check the remaining tape length (except for NTSC-recorded tapes)

Press DISPLAY. The white bar indicates the approximate length of tape remaining.

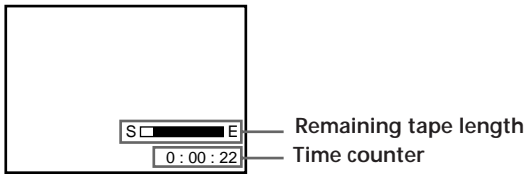

To record stereo and bilingual programmes

Set the connected TV to output stereo or bilingual sound. When stereo or bilingual sound is received through the line inputs, the STEREO indicator lights up. You cannot select the sound to listen to while recording.

How sound is recorded on a video tape

The unit records sound onto two separate tracks. Hi-fi audio is recorded onto the main track along with the picture. Monaural sound is recorded onto the normal audio track along the edge of the tape.

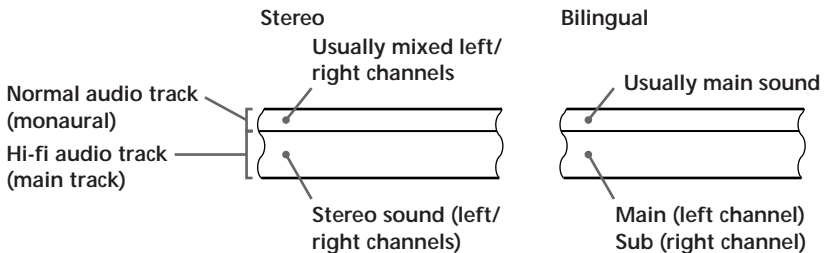

continued

Recording TV programmes (continued)

To save a recording

To prevent accidental erasure, break off the safety tab as illustrated. To record on a tape again, cover the tab hole with adhesive tape.

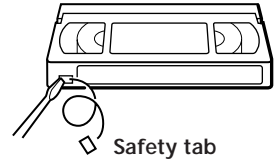

Tip

- The display appears on the TV screen indicating information about the tape, but the information won't be recorded on the tape.

Notes

- Do not turn off the TV nor change the programme position during recording.
- When the KARAOKE ON/OFF switch is set to ON, the unit displays the karaoke information (page 25).
- Make sure the audio/video output of your TV is connected to the LINE-1 IN jacks of the unit.
- Make sure CONNECT L1 in the SET UP MENU is set to TV.
- To record stereo or bilingual programmes, the connected source must have audio left/right output jacks.
- When you play back a tape recorded in the PAL or MESECAM colour system, streaks may appear even if the COLOR SYSTEM switch is set to PAL/MESECAM. If so, select the colour system, PAL or MESECAM in the PAL/MESECAM option of the SET UP MENU. (For details, see page 34.)

Playing/searching at various speeds

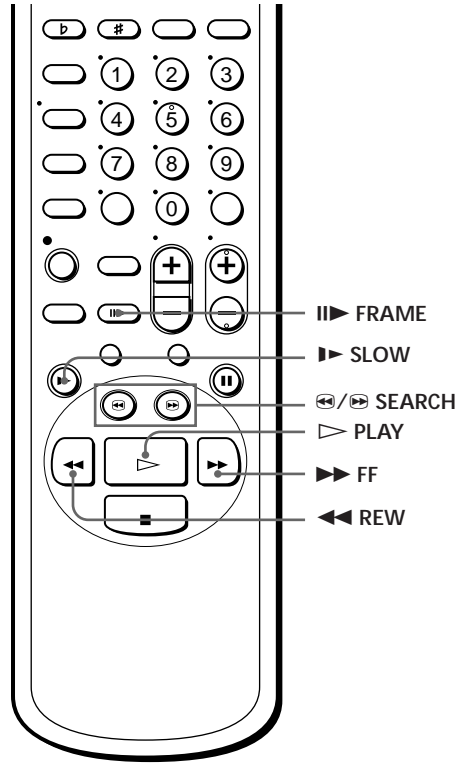

Playback options	Operation
Fast-forward/rewind	During stop, press ►► FF or ◀◀ REW.
View the picture during fast-forward or rewind	During fast-forward, hold ►► FF down. During rewind, hold ◀◀ REW down.
Play at high speed	During playback or pause, press ◀▶ SEARCH or ▶◀ SEARCH. To change the direction, press the other one.
Play in slow motion for two minutes	During playback or pause, press ► SLOW.
Play frame by frame	During pause, press ◻► FRAME. Hold the button down to play one frame each second.
Rewind to the beginning of a tape and start play	During stop, hold ◀◀ REW down <u>on the unit</u> , and press ◻► PLAY <u>on the unit</u> .

To resume normal playback

Press ◻► PLAY.

continued

Recording TV programmes using the easy timer

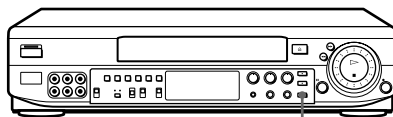

EASY TIMER

You can start recording at once and have the unit stop recording automatically after a specified duration.

Before you start...

- Connect the LINE-1 IN jacks of the unit to the audio/video output jacks of your TV (see “Additional connection” on page 7).
- Set CONNECT L1 to TV in the SET UP MENU.
- Insert a tape with its safety tab in place.
- Press TAPE SPEED to select the tape speed (SP or LP for the PAL system, and SP or EP for the NTSC system).

- 1 Turn on your TV and select the programme position you want to record on your TV.
- 2 Press EASY TIMER repeatedly to set the duration.

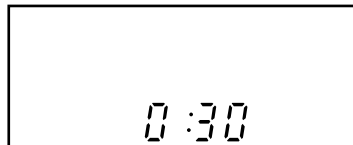

Each press advances the time in increments of 30 minutes.

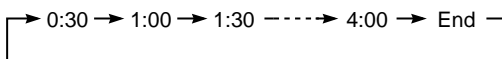

Once you press EASY TIMER, the unit starts recording the TV programme shown on the TV. The TIMER indicator appears in the display window.

The duration decreases minute by minute to 0:00, then the unit stops recording and turns off automatically.

To change the duration

Press EASY TIMER repeatedly to set to the new duration. The previous duration is cleared when you set the new duration.

To stop recording

To stop the unit while recording, press ■ STOP.

Tips

- You can use the easy timer to record other sources. In this case, connect the audio/video output jacks of the source you want to record to the LINE-1 IN jacks of the unit. Then set CONNECT L1 to OTHER in the SET UP MENU.
- If you select “End” for the recording duration, the unit stops recording at the end of the tape and turns off automatically.

Karaoke sing-along

You can sing along with a karaoke videotape, a TV broadcast, or music played back on equipment connected to the LINE IN jacks on the unit. You can sing duets if you use an extra microphone (not supplied).

Singing along with karaoke video tapes

Before you start...

- Turn on the unit and the TV.
- Set the TV to the video channel.
- Connect the supplied microphone to the MIC IN 1 jack and its control plug to the CONTROL jack. To sing duets, connect an optional microphone to the MIC IN 2 jack.
- When CONNECT L1 in the SET UP MENU is set to TV (see page 34), the sound through the microphone is output only during playback. If you want to use a microphone in all modes, set CONNECT L1 in the SET UP MENU to OTHER.

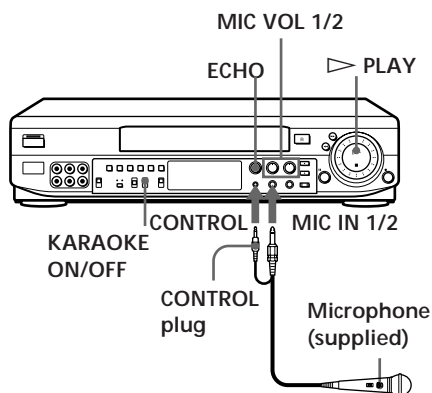

- 1** Set KARAOKE ON/OFF to ON.
“KARAOKE MODE WELCOME TO THE Sony KARAOKE WORLD” appears on the TV screen.
- 2** Insert a karaoke video tape.
The unit starts playing automatically if you insert a tape with its safety tab removed.
- 3** Press ▷ PLAY.
If you want to playback a specific song, see “Searching with the AMS or index function” on page 30.
- 4** Switch the microphone on.
Now you can enjoy singing karaoke.

To adjust the microphone volume

Turn the MIC VOL 1 control for the microphone connected to MIC IN 1.

Turn the MIC VOL 2 control for the microphone connected to MIC IN 2.

Setting the MIC VOL 1 and/or 2 control(s) to the centre position provides the best microphone volume.

To control the echo effect

Turn the ECHO control. This adjusts both microphones' echo effect to the same level.

To get the best effect, adjust the microphone volume to a slightly higher level than the music volume.

Tip

- When you sing along with TV broadcasts or music played back on equipment connected to the LINE IN jacks on the unit, play the music source and follow steps 1 and 4.

Notes

- If the sound is reproduced through a stereo amplifier, turn down the volume of amplifier before operation.
- If streaks appear during playback, select the colour system that the tape was recorded in (see "To set the colour system" on page 13).
- If feedback occurs, turn down the microphone or TV volume, or move the microphone away from the speakers.

Using the supplied microphone

You can control some of the unit's karaoke functions with the microphone.

- 1** CHOI button
Press and hold to rewind the tape while viewing the picture.
- 2** ♭/♯ buttons
Change the pitch in Key Control mode (page 25).
Set the harmony interval in Self Duet mode (page 26).
- 3** KEY/S.D./OFF selector
Select KEY or S.D. to switch the microphone on in the Key Control mode or the Self Duet mode. Select OFF to switch the microphone off.

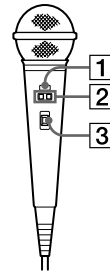

Note

- The ♭/♯ buttons on the microphone may not operate with other VCRs.

continued

Karaoke sing-along (continued)

Playing a tape in a programmed order (Karaoke Program)

You can sing songs in the order you want.

Before you start...

- Turn on your TV and set it to the video channel.
- Select the search mode, AMS or INDEX in the SET UP KARAOKE menu. For details, "Selecting the AMS or index function" on page 30.

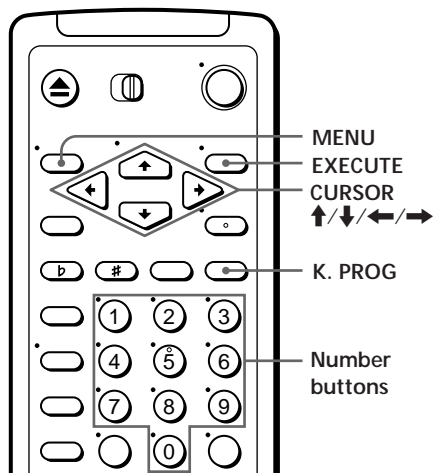

- 1 Insert a tape and set KARAOKE ON/OFF on the unit to ON.
- 2 Press K. PROG.

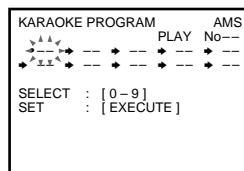

- 3 Press the number buttons to select up to ten songs in the order you want.

For single-digit numbers, first press "0" then the song number. To correct a song number, press CURSOR ← to return to that number and reset it.

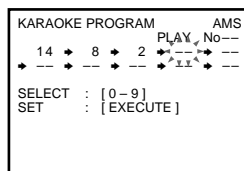

- 4 Press EXECUTE.

The tape automatically rewinds to the beginning, and playback starts in the order you selected. While the unit searches for a song, the song number flashes in the display window.

To stop playing

Press ■ STOP.

To change the programme order

Press ■ STOP and repeat steps 2 through 4 above.

Tip

- You can also select the KARAOKE PROGRAM menu by pressing MENU and CURSOR \uparrow/\downarrow .

Notes

- If you set KARAOKE ON/OFF to OFF, the list settings are cleared.
- When you turn off the unit, the unit exits the KARAOKE PROGRAM mode.
- When you press \lll/\ggg SEARCH AMS/INDEX while in Karaoke Program mode, the unit does not search beyond the current song, but rewinds the tape to the beginning of the song being played back, or fast-forwards to the next song. When the unit exits KARAOKE PROGRAM mode, \lll/\ggg SEARCH AMS/INDEX returns to its normal function. (See "Searching with the AMS or index function" on page 30.)
- If you press CHOI on the microphone and rewind past the beginning of the current song, the selected song order may not be played correctly.

Displaying the karaoke information

Press DISPLAY when the KARAOKE ON/OFF switch is set to ON. The karaoke information appears on the TV screen. If you press DISPLAY once more, the remaining tape length and time counter will also appear.

To turn off the display, press DISPLAY again.

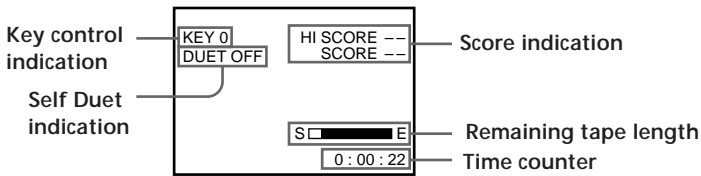

Changing the pitch (Key Control)

While you are singing, you can change the pitch of the song to match your vocal range.

Press KEY CONTROL \flat or \sharp repeatedly to set the pitch you want.

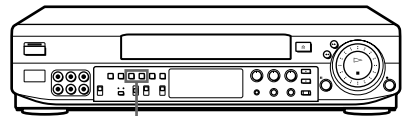
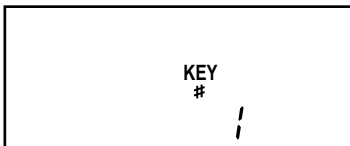

KEY CONTROL \flat/\sharp

continued

Karaoke sing-along (continued)

You can change the pitch of the song in half tone intervals.

To	Press	Range	Display window
Raise the pitch	# (sharp)	8 half tones	"#1" to "#8"
Lower the pitch	b (flat)	8 half tones	"b1" to "b8"

To return to the original pitch

Press KEY CONTROL **b** or **#** repeatedly until "0" appears in the display window.

Tip

- You can also change the pitch with the supplied microphone.

Adding harmony (Self Duet)

You can sing duets by yourself. The unit creates a harmony voice at the interval you want.

Press SELF DUET **b**/**#** to select a high or low harmony voice.

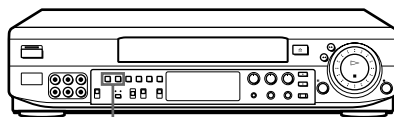

SELF DUET **b**/**#**

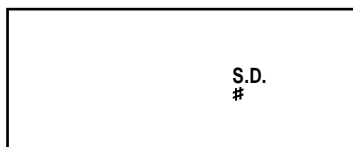

To	Press	Display window
Add a high harmony	# (sharp)	"S.D.#"
Add a low harmony	b (flat)	"S.D.b"

To cancel the Self Duet

Press SELF DUET **b**/**#** again.

Tip

- You can also change the pitch with the supplied microphone and the remote commander.

Reducing the playback vocals (Karaoke Pon)

This function reduces the vocals on played back music sources. You can use hi-fi stereo music sources for karaoke.

Set KARAOKE MODE to KARAOKE PON.

The singer's voice is reduced.

To cancel Karaoke Pon

Set KARAOKE MODE to OFF.

Note

- Karaoke Pon does not work with the following tapes:
 - Tapes on which different vocal sounds are recorded on the left and right channels, such as a duet
 - Monaural recorded tapes
 - Tapes on which sound sources are recorded with strong echo effects and/or chorus-effects

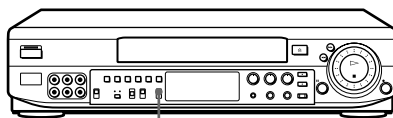

KARAOKE MODE

Backing up your singing (Vocal Assist)

This unit can assist your singing in case you forget the lyrics while you are singing. The unit fills in the vocal for you automatically if you stop singing into the microphone. Use karaoke stereo hi-fi tapes which have the accompaniment music on the left channel and the accompaniment plus vocal on the right channel.

Set KARAOKE MODE to VOCAL ASSIST.

To cancel Vocal Assist

Set KARAOKE MODE to OFF.

Note

- Vocal Assist does not work with the following tapes:
 - Hi-fi tapes on which the same sound is recorded on the left and right channels
 - Monaural recorded tapes

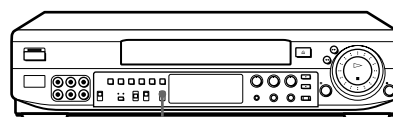

KARAOKE MODE

continued

Karaoke sing along (continued)

Grading your singing

As an extra challenge, the unit can grade your singing.

- 1 Start singing and press SCORE.
"SCORE" appears on the TV screen, and the unit starts analysing your singing.
- 2 Press SCORE again after singing for more than one minute.
Your score appears on the TV screen for five seconds. The highest score (HI SCORE) is saved, and is indicated above your present score.

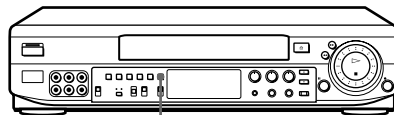

SCORE

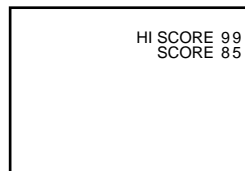

To score automatically (Auto Score)

The unit automatically scores each song in order during Karaoke Program. Press MENU and select SET UP KARAOKE, then set AUTO SCORE to ON.

Each time a song ends, the score appears for five seconds.

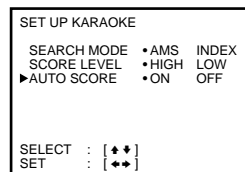

To set the score level

This unit has two different score levels. To set the score level, press MENU and select SET UP KARAOKE. Then set SCORE LEVEL to HIGH for easy grading or LOW for strict grading.

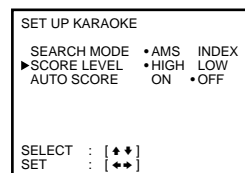

Tips

- The highest possible score is 99 points.
- To display your score on the TV screen again, press DISPLAY.
- The highest score is cleared each time you set the KARAOKE ON/OFF switch to OFF.

Note

- The grading is not absolute. Please use this function for your own amusement.

Competing for the loudest voice

The unit measures and displays the loudness of your voice numerically when you shout into the microphone.

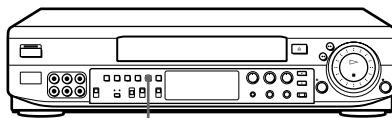

SHOUT

1 Press SHOUT.

“SHOUT” appears in the display window (English on-screen display only) and the unit starts a countdown on the TV screen.

2 Shout into the microphone when the unit counts down to 0.

While you are shouting, the highest score (MAX LEVEL) and your current shout level are displayed on the TV screen with a level meter. Below the level meter, a bar appears every second to show the changes in your shout level.

After five seconds, the measurement is complete, and the highest score (MAX LEVEL) and your score (YOUR LEVEL) appear.

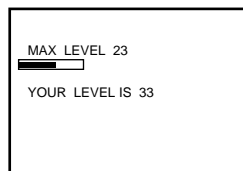

Tips

- To exit SHOUT mode, press SHOUT again.
- The highest score (MAX LEVEL) is cleared each time you set the KARAOKE ON/OFF switch to OFF.

Note

- Adjust the MIC VOL control to the centre position and turn down the TV volume.

Searching with the AMS or index function

You can search for the start of a specific passage or scene. There are two ways for automatic searching depending on the way the tape was recorded.

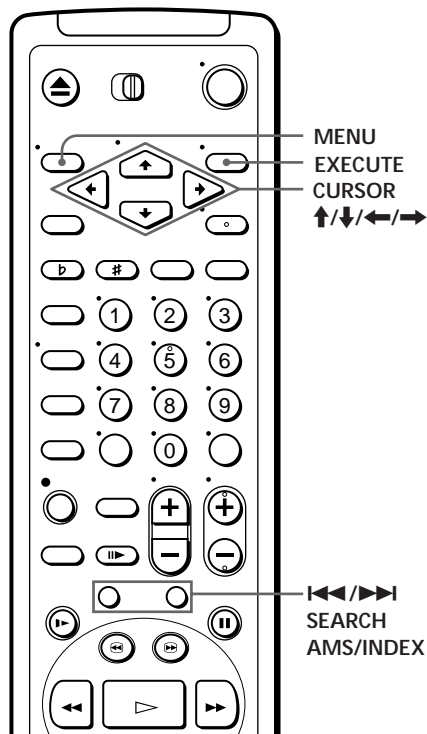

Selecting the AMS or index function

The AMS (Automatic Music Sensor) function is mainly for karaoke tapes. It searches for blank spaces (of at least four seconds) between recorded signals on the sound track of a tape. Use this function to search an index-incompatible tape. If you are not sure of the way the tape was recorded, try AMS first.

The index function is for indexed tapes like the tapes recorded with this unit. The unit marks the tape with an index signal at the point where each recording begins. When you use commercially prerecorded tape, check the packaging to see if the tape is index-compatible.

- 1 Press MENU and select SET UP KARAOKE, then press EXECUTE.
- 2 Press CURSOR ↑/↓/←/→ to select SEARCH MODE, then select either AMS or INDEX.
- 3 Press EXECUTE.

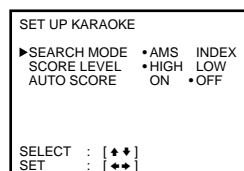

Searching with the AMS function

The unit can search up to 99 blank spaces ahead of or behind the current position.

- 1 Set KARAOKE ON/OFF on the unit to ON.
- 2 Insert a tape into the unit.
- 3 Press ◀◀/▶▶ SEARCH AMS/INDEX repeatedly to specify how many blank spaces ahead or behind you want to search:
 - To search ahead, press ▶▶ SEARCH AMS/INDEX.
 - To search backwards, press ◀◀ SEARCH AMS/INDEX.

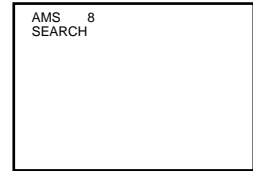

The unit starts searching and the number of blank spaces on the TV screen counts down to zero. Playback starts automatically from that point.

To stop searching

Press ■ STOP.

Searching with the index function

The unit can search up to 99 index signals ahead of or behind the current position.

- 1 Insert an indexed tape into the unit.
- 2 Press ◀◀/▶▶ SEARCH AMS/INDEX repeatedly to specify how many index signals ahead or behind you want to search:
 - To search ahead, press ▶▶ SEARCH AMS/INDEX.
 - To search backwards, press ◀◀ SEARCH AMS/INDEX.

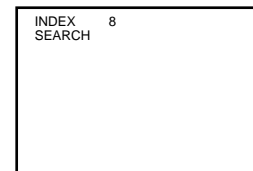

The unit starts searching and the index number on the TV screen counts down to zero. Playback starts automatically from that point.

To stop searching

Press ■ STOP.

Notes

- No index signal will be added when recording starts from recording pause.
- The AMS function only works when the KARAOKE ON/OFF switch is set to ON.
- You cannot use the AMS function on tapes that have many blank spaces in a short time span such as dramas and dialogues.

Enjoying the surround sound (Virtual Sound)

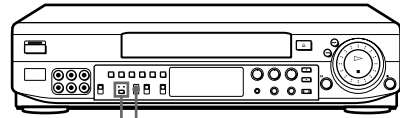

VIRTUAL SOUND switch

EFFECT button

WIDE/WARP indicators

You can use the Virtual Sound function to give stereo sources the surround sound effect and monaural sources a simulated stereo effect.

- 1 Select the type of sound source with the VIRTUAL SOUND switch. Select SURROUND when listening to a stereo source; select SIMULATED STEREO for a monaural source.
- 2 Press EFFECT so the WIDE or WARP indicator lights up.

Virtual sound

Type	Effect	For
SURROUND (stereo)	WIDE	A sound effect that spreads out over a large area
	WARP	A sound effect that totally envelopes you in sound
SIMULATED STEREO (monaural)	WIDE	A simulated stereo effect
	WARP	A wide ranging simulated stereo effect

To cancel the Virtual Sound

Press EFFECT repeatedly until both WIDE/WARP indicators turn off.



Notes

- This function is available only when the tape sound is reproduced on a stereo TV (or other stereo audio equipment). If the connected TV or other audio equipment is monaural or simulated stereo, you cannot get a clear effect.
- We recommend that you do not use the surround effect function of this unit and that of the connected TV (or other audio equipment) at the same time. If you do so, the function may not work properly because the effects overlap each other.

Adjusting the picture

Adjusting the tracking

Although the unit automatically adjusts the tracking when playing a tape (the tracking indicator  flashes in the display window, then goes off), distortion may occur if the tape was recorded in poor condition. If so, manually adjust the tracking.

Press TRACKING NORM/SLOW  /  to display the tracking meter. The distortion should disappear as you press one of the two buttons (The  indicator lights up).

If you cannot get a clear picture with manual adjustment, press TRACKING AUTO/MANU to return to automatic adjustment.

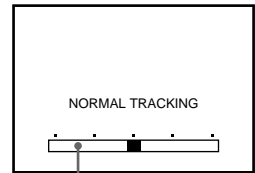

About Adaptive Picture Control (APC)

Adaptive Picture Control (APC) automatically improves recording and playback quality by adjusting the unit to the condition of the video heads and tape. To maintain better picture quality, we recommend that you set APC to ON in the SET UP MENU (with the APC indicator in the display window lit).

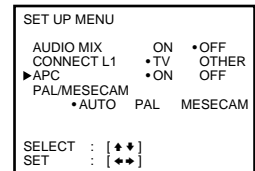

APC playback

The APC function automatically works on all types of tapes, including rental tapes and tapes that were not recorded with APC.



APC recording

Whenever you insert a tape and start recording for the first time, the unit adjusts to the tape using the APC function (the APC indicator flashes rapidly). This adjustment is retained until the tape is ejected.

To deactivate the APC

Press MENU and select SET UP MENU, then set APC to OFF. The APC indicator in the display window goes off.

Note

- There is a delay of a few seconds before the unit actually starts recording while the unit analyses the tape. To avoid the delay, first set the unit to recording pause (the APC indicator flashes slowly) and press  REC to have the unit analyse the tape (the APC indicator flashes rapidly). After the APC indicator stops flashing, press  PAUSE to start recording immediately. If you want to start recording quickly without using the APC function, first set the unit to recording pause (the APC indicator flashes slowly) and press  PAUSE to start recording.

Changing menu options

- 1 Press MENU, then select SET UP MENU.

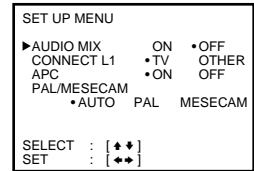

- 2 Press CURSOR **↑/↓** to select the option to change, then press CURSOR **←/→** to change the setting.
- 3 Press EXECUTE to return to the original screen.

Menu choices

Initial settings are indicated in bold print.

Menu option	Set this option to
AUDIO MIX	<ul style="list-style-type: none"> • ON to listen to the hi-fi and normal audio tracks at the same time. The AUDIO MONITOR button will not function. • OFF to listen to hi-fi and normal audio tracks separately. Select the sound using the AUDIO MONITOR button. <p>For details, see page 38.</p>
CONNECT L1	<ul style="list-style-type: none"> • TV to record TV programmes using the LINE-1 IN jacks. • OTHER to record other audio/video sources using the LINE1-IN jacks. <p>For details, see page 7.</p>
APC	<ul style="list-style-type: none"> • ON to switch on the APC (Adaptive Picture Control) function and improve picture quality • OFF to switch off APC. <p>For details, see page 33.</p>
PAL/MESECAM	<ul style="list-style-type: none"> • AUTO to record/play back in the colour system selected automatically. Normally, select AUTO. • PAL to record/play back in the PAL colour system. • MESECAM to record/play back in the MESECAM colour system. <p>For details, see page 15.</p>

Connecting to a VCR or stereo system

How to connect to record on this unit

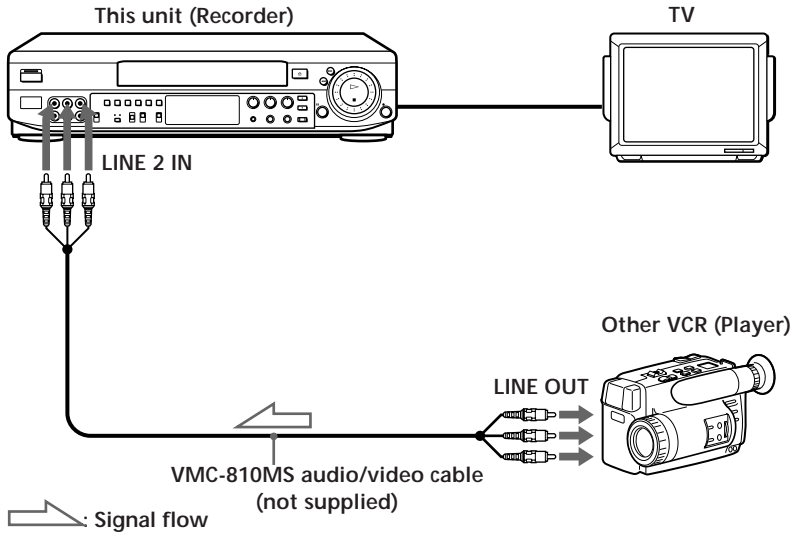

Notes

- You can also use the LINE-1 IN jacks instead. If you do, set CONNECT L1 to OTHER in the SET UP MENU.
- Make sure you connect the plugs to jacks of the same colour.
- If the other VCR is a monaural type, connect the audio plug to the AUDIO L (white) jack. The sound is recorded on both right and left channels. When connecting to the AUDIO R (red) jack, the sound is recorded only on the right channel.
- If you connected this unit to both the LINE IN and LINE OUT jacks of the other VCR, select the input correctly to prevent a humming noise.

How to connect to a stereo system

Connect LINE 2 IN AUDIO on this unit to the audio output jacks on the stereo system, using the RK-C510KS audio cable (not supplied).

Basic editing

(when recording on this unit)

Before you start editing

- Turn on your TV and set it to the video channel.
- Press INPUT SELECT to display “L2” (or “L1”) in the display window.
- Press TAPE SPEED to select the tape speed (SP or LP for the PAL system, and SP or EP for the NTSC system).

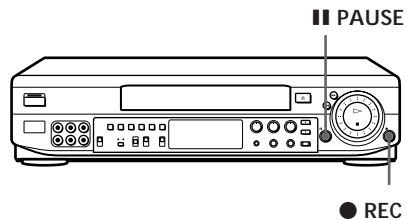

- 1 Insert a source tape with its safety tab removed into the other (playback) VCR. Search for the point to start playback and set it to playback pause.
- 2 Insert a tape with its safety tab in place into this (recording) unit. Search for the point to start recording and press || PAUSE.
- 3 Press ● REC on this unit and set it to recording pause.
- 4 To start editing, press the || PAUSE buttons on both units at the same time.

To stop editing

Press the ■ STOP buttons on both units.

Tips

- To edit more precisely, press the || PAUSE buttons on the units to release pause.
- To cut out unwanted scenes while editing, press || PAUSE on this unit when an unwanted scene begins. When it ends, press || PAUSE again to resume recording (Assemble editing).
- You can dub sound onto the normal audio track through a microphone while editing. Set KARAOKE ON/OFF to ON before you start dubbing.

Note

- If you start recording following the procedure above, the unit won't start recording with the APC function. To record a tape with the APC function, press ● REC again during recording pause in step 3 so that the unit analyses the tape. Then when you start recording in step 4, press || PAUSE after the APC indicator stops flashing. If you press || PAUSE before the APC indicator stops flashing, the APC function is cancelled.

Audio dubbing

This feature lets you record over the normal audio track. The monaural sound previously recorded is replaced while the original hi-fi sound remains unchanged. Use this feature to add commentary to a tape that you have recorded with a camcorder. You can also record your karaoke performances.

Audio dubbing from a stereo system or other external source

Before you start dubbing

- Turn on your TV and set it to the video channel.
- Press INPUT SELECT on the unit to display “L2” in the display window.

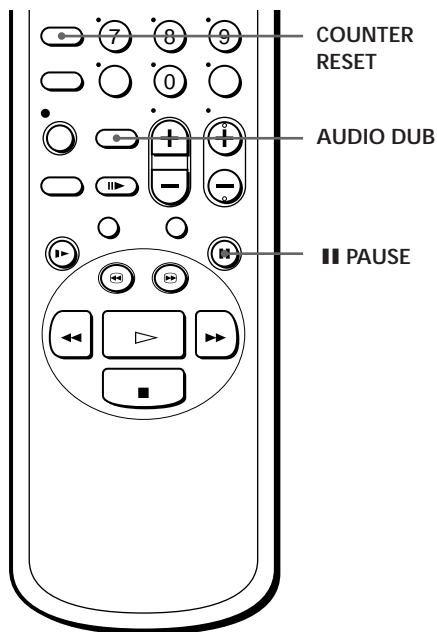

- 1 Insert a source tape into the stereo system (or the playback VCR). Search for the point to start playback and set it to playback pause.
- 2 Insert a prerecorded tape into this (recording) unit. Search for the end of the section to be replaced and press **|| PAUSE**.
Make sure that the tape has its safety tab in place.
- 3 Press COUNTER RESET to reset the counter to “0H00M00S.”
- 4 Rewind the prerecorded tape to the beginning of the section to be replaced.
The unit pauses.
- 5 Press AUDIO DUB.
The audio dubbing indicator ⊖ appears in the display window.
- 6 To start editing, press the **|| PAUSE** buttons on this unit and the stereo system (or other VCR) at the same time.
When the counter reaches “0H00M00S,” audio dubbing stops automatically.

To stop while editing

Press the **■ STOP** buttons on this unit and the stereo system (or other VCR).

continued

Audio dubbing (continued)

To listen to both the hi-fi and normal audio

Set AUDIO MIX to ON in the SET UP MENU (page 34). Use this feature to listen to dubbed audio over the original hi-fi audio. When AUDIO MIX is set to ON, the AUDIO MONITOR button does not function. Remember to reset AUDIO MIX to OFF after playing the tape.

To listen to the dubbed sound (normal audio)

Press AUDIO MONITOR until the “L,” “R,” and “STEREO” indicators go off in the display window.

Audio dubbing from the microphone

Using the microphone, you can add songs or narration on a recorded tape. Sound from the microphone is mixed with the original hi-fi sound and recorded on the normal audio track.

Before you start dubbing

- Connect the microphone(s) to the MIC IN 1 and/or 2 jack(s), and turn on the microphone(s).

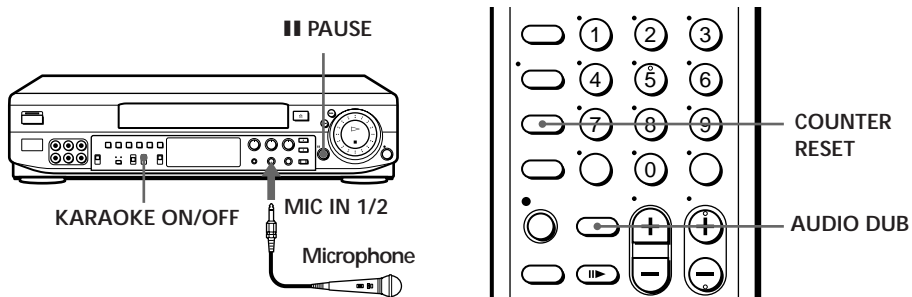

- 1 Set KARAOKE ON/OFF to ON.
- 2 Insert the prerecorded tape into the unit. Search for the end of the section to be replaced and press **|| PAUSE**.
Make sure that the tape has its safety tab in place.
- 3 Press COUNTER RESET to reset the counter to “0H00M00S.”
- 4 Rewind the prerecorded tape to the beginning of the section to be replaced.
The unit pauses.
- 5 Press AUDIO DUB.
The audio dubbing indicator \ominus appears in the display window.

-
- 6** To start editing, press **|| PAUSE** to start dubbing and sing or speak into the microphone.

When the counter reaches “0H00M00S,” audio dubbing stops automatically.

To stop while recording

Press **■ STOP**.

To listen to the dubbed sound

Press **AUDIO MONITOR** until the “L,” “R,” and “STEREO” indicators go off in the display window.

To record sound from the microphone mixed with an external source

If you connect equipment such as a laser disc player to this unit’s **LINE 2 IN** jacks, you can record while singing along to a karaoke LD. Be sure to press **INPUT SELECT** on the unit to display “L2” before starting recording. The mixed sound is recorded on the normal audio track, and the sound input from the **LINE 2 IN** jacks is recorded on the hi-fi audio track.

Tip

- When dubbing from the microphone, you can use the functions of echo effect, Key Control, and Self Duet.

Notes

- Do not dub on a tape recorded in LP mode. Audio noise may occur.
- Recording stops if you press **COUNTER RESET** while audio dubbing.

Troubleshooting

If you have any questions or problems not covered below, please consult your nearest Sony service facility.

	Symptom	Remedy
Power	The ON/STANDBY switch does not function.	<ul style="list-style-type: none"> • Connect the mains lead to mains securely.
	The power is turned on but the unit does not operate.	<ul style="list-style-type: none"> • Moisture condensation occurs. Turn the power off, unplug the mains lead and leave the unit to dry for over one hour.
Playback	The playback picture does not appear on the TV screen.	<ul style="list-style-type: none"> • Make sure the TV is set to the video channel. If you are using a monitor, set it to video input.
	The picture is not clear.	<ul style="list-style-type: none"> • Adjust the tracking with the TRACKING NORM/SLOW ◀/▶ buttons. • Make sure the colour system is correctly set to the system that the tape was recorded in. • The video heads are dirty (see below). Clean the video heads using the Sony V-25CL video head cleaning cassette. If this cleaning cassette is not available in your area, have the heads cleaned at your nearest Sony service facility (a standard service charge will be required). Do not use a commercially available wet-type cleaning cassette, as it may damage the video heads. • The video heads may have to be replaced. Consult your local Sony service facility for more information.
	The picture rolls vertically during picture search.	<ul style="list-style-type: none"> • Adjust the vertical hold control on the TV or monitor.
	The picture has no sound.	<ul style="list-style-type: none"> • The tape is defective. Use a new tape.
	The sound is unstable or has an echo.	<ul style="list-style-type: none"> • When you play a tape with the same sound recorded on both the hi-fi and normal sound tracks, make sure the AUDIO MIX option in the SET UP MENU is set to OFF.

Symptoms caused by contaminated video heads

• Normal picture

• Rough picture

• Unclear picture

• No picture (or black & white screen appears)



initial



terminal

	Symptom	Remedy
Recording	The tape starts playing as soon as it is inserted.	<ul style="list-style-type: none"> The safety tab has been removed. To record on this tape, cover the tab hole.
	The tape is ejected when you press ● REC.	<ul style="list-style-type: none"> Check that the safety tab has not been removed.
	Nothing happens when you press ● REC.	<ul style="list-style-type: none"> Make sure the tape is not at its end. Select the correct source with the INPUT SELECT button.
Others	A tape cannot be inserted.	<ul style="list-style-type: none"> Check that a tape isn't already in the tape compartment.
	The remote commander does not function.	<ul style="list-style-type: none"> Make sure you are pointing the remote commander at the remote sensor on the unit. Replace all the batteries in the remote commander with new ones if they are weak. Make sure the <input type="checkbox"/>TV/<input type="checkbox"/>VIDEO remote control switch is set correctly.
	The tracking indicator does not appear on the screen.	<ul style="list-style-type: none"> The recording condition of the tape is very poor and tracking cannot be adjusted, or the NTSC system is being used.
	The unit needs to be cleaned.	<ul style="list-style-type: none"> Clean the cabinet, panel and controls with a dry, soft cloth, or a soft cloth slightly moistened with a mild detergent solution. Do not use any type of solvent, such as alcohol or benzine.
	The AMS function does not work properly.	<ul style="list-style-type: none"> The tape has too many blank spaces in a short time span. Change PROGRAM MODE in the SET UP KARAOKE menu from AMS to INDEX.

Specifications

System

RF output signal

UHF channels 30 to 39

Aerial out

75-ohm asymmetrical aerial socket

Inputs and outputs

LINE-1 IN and LINE 2 IN

VIDEO IN, phono jack (1 each)

Input signal: 1 Vp-p, 75 ohms, unbalanced,
sync negative

AUDIO IN, phono jack (2 each)

Input level: 327 mVrms

Input impedance: more than 47 kilohms

LINE-1 OUT and LINE 2 OUT

VIDEO OUT, phono jack (1 each)

Output signal: 1 Vp-p, 75 ohms, unbalanced,
sync negative

AUDIO OUT, phono jack (2 each)

Standard output: 327 mVrms

Load impedance: 47 kilohms

Output impedance: less than 10 kilohms

General

Power requirements

110 – 240 V AC, 50/60 Hz

Power consumption

25 W

Operating temperature

5°C to 40°C

Storage temperature

-20°C to 60°C

Dimensions

Approx. 430 × 100 × 282 mm (w/h/d)
including projecting parts and controls

Mass

Approx. 4.5 kg

Supplied accessories

Remote commander (1)

R6 (size AA) batteries (2)

Aerial cable (1)

Audio/video cable (3-phono to 3-phono) (1)

Microphone (1)

Plug adaptor (1) (SLV-KH7ME only)

Design and specifications are subject to change
without notice.

Index to parts and controls

Refer to the pages indicated in parentheses () for details.

Front panel

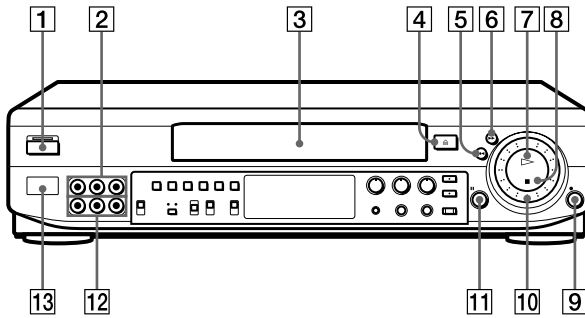

- | | |
|---|--|
| 1 ON/STANDBY switch/indicator (9) | 8 ■ STOP button (13, 16) |
| 2 LINE 2 IN AUDIO L/R/VIDEO jacks (35) | 9 ● REC button (16) |
| 3 Tape compartment | 10 CLICK SHUTTLE ring (20) |
| 4 ▲ EJECT button (13) | 11 ■ PAUSE button (13, 36) |
| 5 ◀◀ REW button (13, 19) | 12 LINE 2 OUT AUDIO L/R/VIDEO jacks |
| 6 ▶▶ FF button (13, 19) | 13 Remote sensor (5) |
| 7 ▷ PLAY button (12) | |

continued

Index to parts and controls (continued)

Front panel (continued)

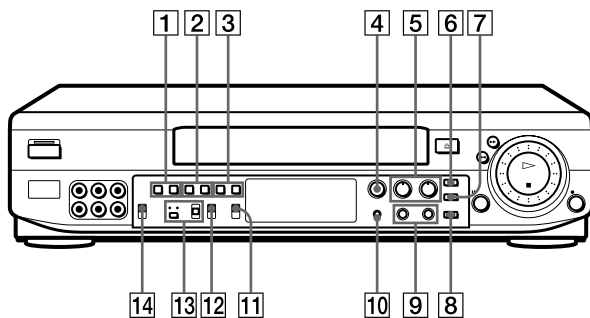

- | | |
|---|---|
| 1 SELF DUET b/# buttons (26) | 9 MIC IN 1/2 jacks (22) |
| 2 KEY CONTROL b/# buttons (25) | 10 CONTROL jack (22) |
| 3 SHOUT button (29)
SCORE button (28) | 11 KARAOKE MODE switch (27) |
| 4 ECHO control (23) | 12 KARAOKE ON/OFF switch (22, 24) |
| 5 MIC VOL 1/2 controls (22) | 13 VIRTUAL SOUND switch (32)
EFFECT button (32) |
| 6 INPUT SELECT button (9, 16) | WIDE/WARP indicators (32) |
| 7 TAPE SPEED button (16) | 14 COLOR SYSTEM switch (13) |
| 8 EASY TIMER button (21) | |

Display window

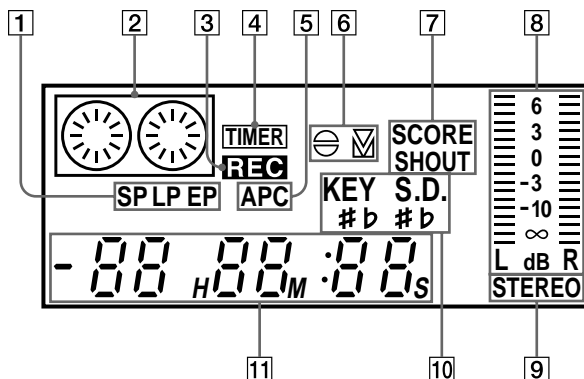

- | | | | |
|---|---|----|---|
| 1 | Tape speed indicator (16) | 7 | SCORE/SHOUT indicators (28, 29) |
| 2 | Tape indicator | 8 | Audio channel/sound level indicator (14) |
| 3 | REC indicator | 9 | STEREO indicator (14) |
| 4 | TIMER indicator (21) | 10 | KEY/S.D./#b indicators (25, 26) |
| 5 | APC indicator (33) | 11 | Time counter/line/pitch adjustment indicator (14, 16, 25) |
| 6 | ⊖ (Audio dub) indicator (37)
☑ (Tracking) indicator (33) | | |

Rear panel

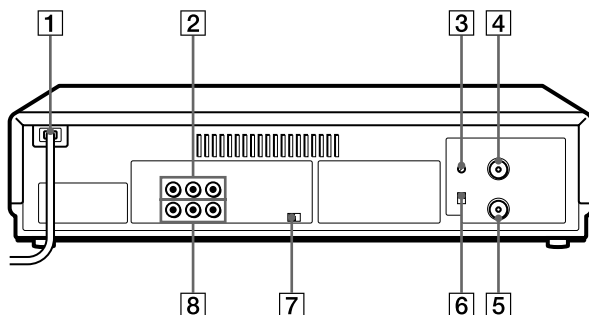

- | | | | |
|---|-------------------------------------|---|--------------------------------------|
| 1 | Mains lead (6, 8) | 5 | AERIAL IN connector (8) |
| 2 | LINE-1 IN AUDIO L/R/VIDEO jacks (7) | 6 | TV SYSTEM switch (10) |
| 3 | RF-CH screw (10) | 7 | NTSC PB switch (13) |
| 4 | AERIAL OUT connector (8) | 8 | LINE-1 OUT AUDIO L/R/VIDEO jacks (6) |

continued

Index to parts and controls (continued)

Remote commander

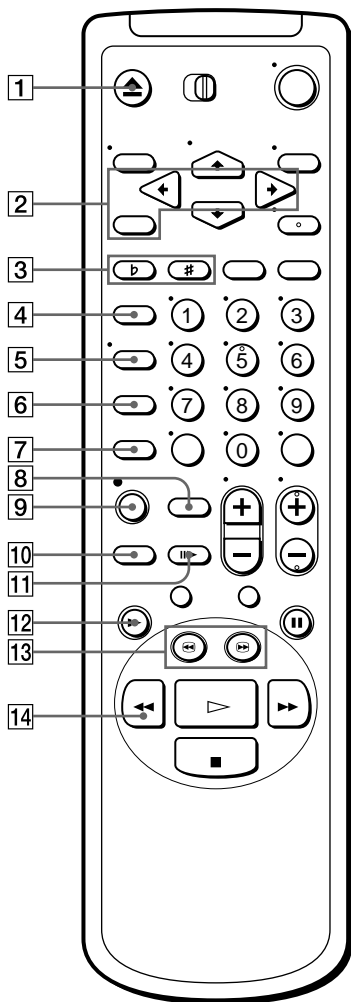

- 1 ▲ EJECT button (13)
- 2 Tracking buttons (33)
TRACKING NORM/SLOW
◀/▶ buttons
TRACKING AUTO/MANU button
- 3 SELF DUET b/# buttons (26)
- 4 EFFECT button (32)
- 5 DISPLAY button (17, 25)
- 6 COUNTER RESET button (14)
- 7 REPLAY button (13)
- 8 AUDIO DUB button (37, 38)
- 9 ● REC button (16)
- 10 TRINITRON TV SYNCHRO PLAY button (15)
- 11 ||▶ FRAME button (19)
- 12 ▶ SLOW button (19)
- 13 ◀▶/▶ SEARCH buttons (13, 19)
- 14 ◀◀ REW button (13, 19)

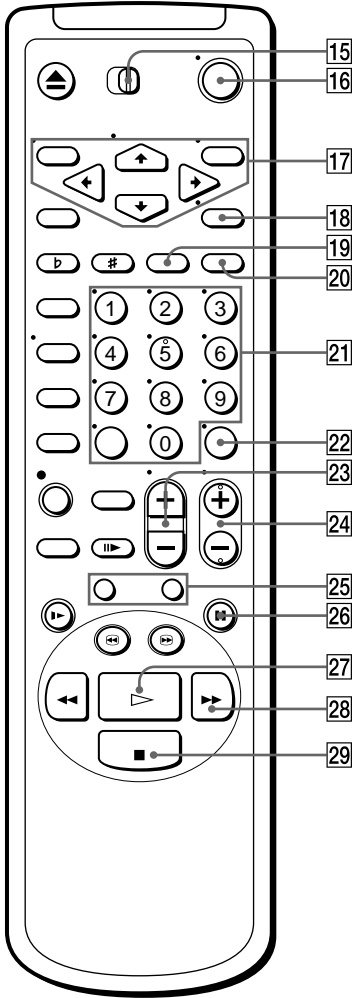

- 15 TV/VIDEO remote control switch (5)
- 16 ⏻ (on/standby) switch
- 17 Menu buttons (11)
MENU button
CURSOR ↑/↓/←/→ buttons
EXECUTE button
- 18 AUDIO MONITOR button (14, 38)
- 19 SCORE button (28)
- 20 K. PROG button (24)
- 21 Number/-/-- (ten's digit) buttons (24)
- 22 TV/VIDEO button (for TV) (5)
- 23 VOL +/- buttons (for TV)
- 24 PROG +/- buttons (for TV)
- 25 ⏮/⏭ SEARCH AMS/INDEX buttons (31)
- 26 ⏸ PAUSE button (13)
- 27 ▷ PLAY button (12)
- 28 ⏭ FF button (13, 19)
- 29 ■ STOP button (13, 16)

Index

A, B

- Accessories supplied 4
- Adjusting
 - picture 20, 33
 - tracking 33
- Aerial hookup 8
- AMS searching 31
- APC (Adaptive Picture Control) 33
- Audio dubbing 37
- Audio track 17
- AV connection 6

C

- Cleaning the video heads 40
- Colour system
 - compatible colour systems 2
 - setting 13
- Connecting
 - to a stereo system 8
 - to a TV with an aerial cable 8
 - to a TV with audio/video jacks 6
- Counter 14

D

- Dubbing. *See* Editing

E, F, G

- Easy timer 21
- Editing 35
- EP mode 17

H

- Hi-fi audio track 17

I, J

- Index searching 31

K

- Karaoke sing along 22
 - competing for the loudest voice 29
 - grading your singing 28
- Karaoke Pon 27
- Karaoke Program 24
- Key Control 25
- Self Duet 26
- Vocal Assist 27

L

- Language selecting 11
- LP mode 16

M

- Monitoring during playback 14

N, O

- Normal audio track 17
- NTSC-recorded tapes 13

P, Q

- Picture adjustment. *See* Adjusting
- Playback 12
 - at various speeds 19
 - frame-by-frame 19
 - slow motion 19

R

- Recording 16
 - bilingual programmes 17
 - saving 18
 - stereo programmes 17
 - from a TV 16
- Remote commander 5

S

- Safety tab 18
- Searching
 - at various speeds 19
 - using the index/AMS function 30
- SP mode 16

T, U

- Tracking adjustment. *See* Adjusting
- Trinitron TV Synchro Play 15

V, W, X, Y, Z

- Virtual Sound 32