

Portable MiniDisc Recorder

Operating instructions



MZ-R30

WARNING

To prevent fire or shock hazard, do not expose the unit to rain or moisture.

To avoid electrical shock, do not open the cabinet. Refer servicing to qualified personnel only.

Caution

The use of optical instruments with this product will increase eye hazard.

Information

For Customers in the USA

This equipment has been tested and found to comply with the limits for a Class B digital device, pursuant to Part 15 of the FCC rules.

These limits are designed to provide reasonable protection against harmful interference in a residential installation. This equipment generates, uses, and can radiate radio frequency energy and, if not installed and used in accordance with the instructions, may cause harmful interference to radio communications.

However, there is no guarantee that interference will not occur in a particular installation. If this equipment does cause harmful interference to radio or television reception, which can be determined by turning the equipment off and on, the user is encouraged to try to correct the interference by one more of the following measures:

- Reorient or relocate the receiving antenna.
- Increase the separation between the equipment and the receiver.
- Connect the equipment into an outlet on a circuit different from that to which the receiver is connected.
- Consult the dealer or an experienced radio/TV technician for help.

You are cautioned that any changes or modifications not expressly approved in this manual could void your authority to operate this equipment.

The built-in battery should be replaced by qualified personnel only.

For Customers in Australia

If the supply cord of AC power adaptor is damaged the AC power adaptor must be returned to the manufacturer of his agent for the cord to be replaced.

IN NO EVENT SHALL SELLER BE LIABLE FOR ANY DIRECT, INCIDENTAL OR CONSEQUENTIAL DAMAGES OF ANY NATURE, OR LOSSES OR EXPENSES RESULTING FROM ANY DEFECTIVE PRODUCT OR THE USE OF ANY PRODUCT.

Owner's Record

The serial number is located at the rear of the disc compartment lid and the model number is located at the bottom. Record the serial number in the space provided below. Refer to them whenever you call upon your Sony dealer regarding this product.

Model No. MZ-R30

Serial No. _____

"MD WALKMAN" is a trademark of Sony Corporation.

Welcome!

Welcome to the world of the MiniDisc!
Here are some of the capabilities and features you'll discover with the new MiniDisc Recorder.

- High-fidelity recording — High-fidelity sound with little noise and distortion is recorded through the optical digital input jack on the recorder.
- Vertical jog dial — You can select your desired tracks directly by simply rotating a dial.
- Synchro-recording — You can easily dub a digital source such as a CD on an MD.
- Sampling rate converter — This unit enables you to record programs from digital equipment using other sampling rates, such as a BS tuner or DAT deck.
- Long-time recording with monaural sound — You can record up to 148 minutes on a disc using monaural recording.
- Position pointer — The display shows you the current location on the disc.
- Date and time stamp function — The built-in clock allows you to record the date and time whenever you make a recording.
- Title function — You can see disc and track titles in the display while you are playing/recording an MD.

Table of contents

Recording an MD right away!	6
-----------------------------------	---

Playing an MD right away!	8
---------------------------------	---

Various ways of recording	10
---------------------------------	----

Two ways of connection to a sound source	10
Recording with digital input	11
To start/stop recording with the player (Synchro-recording) ..	11
Recording from a microphone	12
Recording in monaural for double the normal recording time of an MD	12
Adjusting the recording level (Manual recording)	13
Checking the remaining time or the recording position	14
Setting the clock to stamp the recorded time	15

Various ways of playback	16
--------------------------------	----

Selecting the track number or track name directly	16
Playing tracks repeatedly	16
Emphasizing bass (DIGITAL MEGA BASS)	17
Protecting your hearing (AVLS)	17
Checking the remaining time or the playing position	18
Locking the controls	18
Connecting to a stereo system	19

Editing recorded tracks	20
-------------------------------	----

Erasing tracks	20
To erase a track	20
To erase the whole disc	20
Adding a track mark	21
Erasing a track mark	21
Moving recorded tracks	22
Labeling recordings	22

Power sources	24
Using on a lithium ion rechargeable battery	24
Using on dry batteries	25

Additional information	26
Precautions	26
Troubleshooting	28
System limitations	30
Error messages	31
Specifications	33
What is MD?	34
Looking at the controls	36

Recording an MD right away!

The source sound of CDs or tapes will be sent as an analog signal and recorded digitally. The recorded sound will be stereo. When you record from a digital source, see “Recording with digital input” (page 11).

1 Make connections.

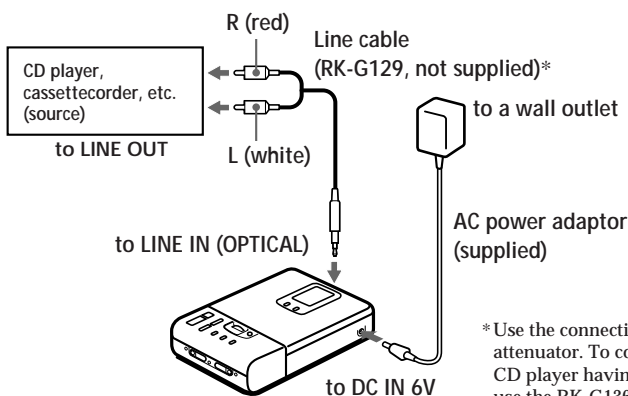

* Use the connecting cords without an attenuator. To connect to a portable CD player having a stereo mini-jack, use the RK-G136 connecting cord (not supplied).

2 Insert a recordable MD.

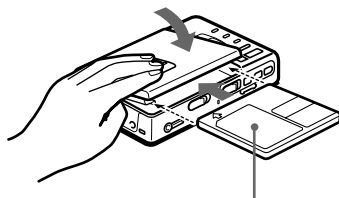
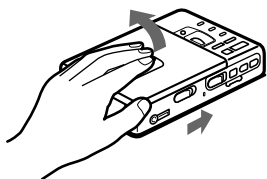

3 Record an MD.

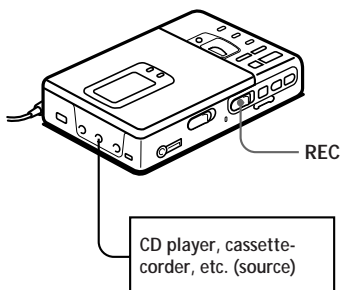

- 1 Slide REC to the right while pressing its button.
"REC" lights up and recording starts.
- 2 Play the CD or tape you want to record.

To stop recording, press **P**.
"Toc Edit" flashes to record data of the recording (the track's start and end points, etc.). Do not move or jog the recorder or disconnect the power source while the indication is flashing in the display.

To	Press
Pause	P ¹⁾ Press P again to resume recording.
Add recording to the end of the previous recording.	END SEARCH and slide REC .
Record over partway through the previous recording.	(, + or = to find the start point of recording and press P to stop. Then slide REC .
Remove the MD.	P and open the lid. ²⁾

¹⁾ A new track is added at the point where you pressed **P**, and the recording will be marked with the new track number when you resume recording.

²⁾ Once you open the lid, the point to start recording will change to the beginning of the first track. When recording on a recorded MD, check the point to start recording on the display.

If the recording does not start

- Make sure the recorder is not locked (page 18).
- Make sure the MD is not record-protected (page 27).
- Premastered MDs cannot be recorded over.

Z

- The level of the recorded sound is adjusted automatically.
- You can monitor the sound being recorded. Connect the supplied headphones with remote controller to 2 / REMOTE and adjust the volume by pressing **VOLUME +/-** (**VOL +/-** on the remote controller). Sound levels are copied onto the MD automatically and independently of the volume for monitoring.

Playing an MD right away!

You can also use the rechargeable battery or dry batteries (see pages 24, 25).

1 Make connections.

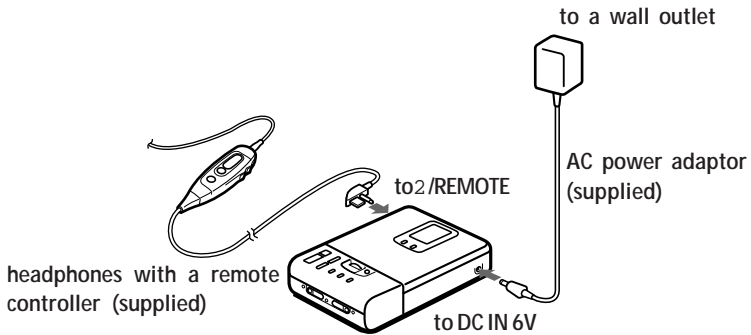

2 Insert an MD.

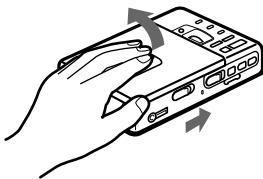

1 Slide OPEN and open the lid.

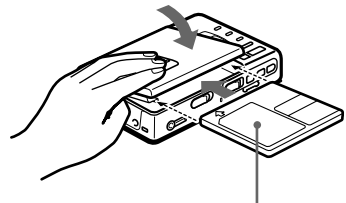

2 Insert an MD with the label side facing up, and press the lid down to close.

3 Play an MD.

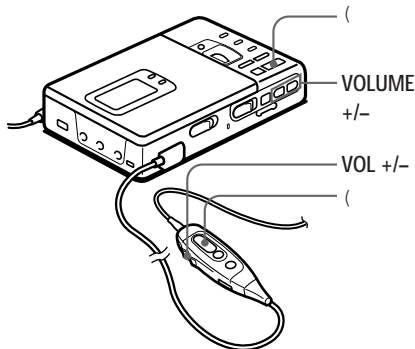

- 1 Press ().
A short beep sounds in the headphones.
- 2 Press **VOLUME +/-** to adjust the volume.
You can check the volume in the display.

To stop play, press **P** .
A long beep sounds in the headphones.

To	Press (Beeps in the headphones)
Pause	P (Continuous short beeps) Press P again to resume play.
Find the beginning of the current track	= once (Three short beeps)
Find the beginning of the next track	+ once (Two short beeps)
Go backwards while playing ¹⁾	keep pressing =
Go forward while playing ¹⁾	keep pressing +
Remove the MD	P and open the lid. ²⁾

¹⁾ To go backward or forward quickly without listening, press **P** and keep pressing **=** or **+** .

²⁾ Once you open the lid, the point to start play will change to the beginning of the first track.

注意

Make sure the recorder is not locked (page 18).

z

The recorder automatically switches to play the stereo or monaural sound according to the recorded sound.

z Various ways of recording

Two ways of connection to a sound source

6 lej nE
Da t nr
gE e nr
sy hE nE

Difference between digital and analog inputs

Difference (connection)	Input	Digital input	Analog (line) input
6 lej nE	lej nE	lej nE	lej nE
Da t nr	lej nE	lej nE	lej nE
gE e nr	lej nE	lej nE	lej nE
sy hE nE	lej nE	lej nE	lej nE
6 lej nE	lej nE	lej nE	lej nE
Da t nr	lej nE	lej nE	lej nE
gE e nr	lej nE	lej nE	lej nE
sy hE nE	lej nE	lej nE	lej nE
6 lej nE	lej nE	lej nE	lej nE
Da t nr	lej nE	lej nE	lej nE
gE e nr	lej nE	lej nE	lej nE
sy hE nE	lej nE	lej nE	lej nE

6 lej nE
Da t nr
gE e nr
sy hE nE

Recording with digital input

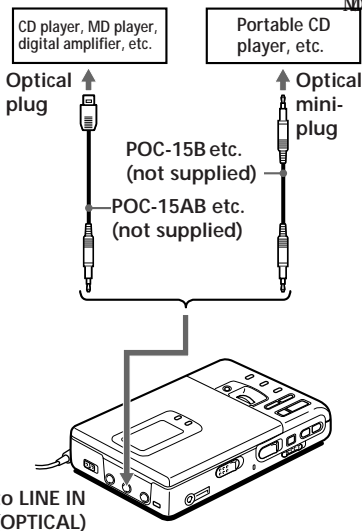

To start/stop recording with the player (Synchro-recording)

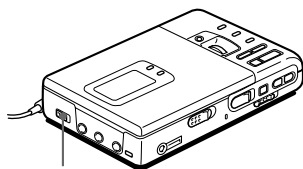

SYNCHRO REC

- Slide SYNCHRO REC to ON. "SYNC" appears in the display.

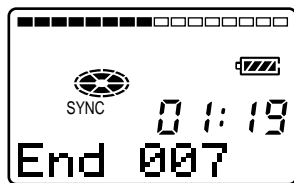

- Slide REC to the right while pressing its button. The recorder stands by for recording. Play the source player. The recorder starts recording when it receives the playing sound.

When there is no sound from the player more than 3 seconds during synchro-recording, the recorder stands by for recording automatically. When the sound comes from the player again, the recorder starts synchro-recording again.

- Do not switch SYNCHRO REC after step 2. Recording may not be made properly.
- If you record in monaural, do steps 1 and 2 in "Recording in monaural for double the normal recording time of an MD" (page 12) before doing the synchro-recording steps.

Recording from a microphone

Figuras a G
 tã ,re E
 E
 lej

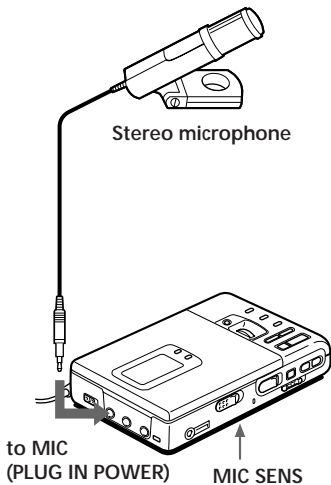

1
 6
 hã
 ti
 a
 K

2
 hã
 hã
 hã
 hã
 hã

hã
 hã
 hã
 hã

Recording in monaural for double the normal recording time of an MD

hã
 hã
 hã

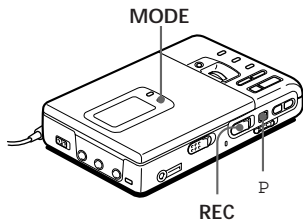

1
 hã
 hã
 hã

2
 hã
 hã
 hã

3
 hã

4
 hã

hã
 hã
 hã

hã
 hã
 hã
 hã
 hã
 hã
 hã
 hã
 hã
 hã
 hã

P

Adjusting the recording level (Manual recording)

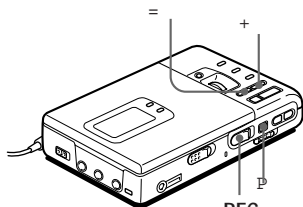

REC
 REC button is used to start recording. Pressing the REC button starts recording.

Level meter

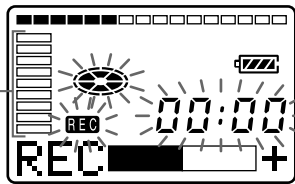

Volume decreases increases

1

Press the REC button to start recording. The level meter shows the recording level. Adjust the volume control slider to the desired level.

4

Press the REC button to start recording. The level meter shows the recording level. Adjust the volume control slider to the desired level.

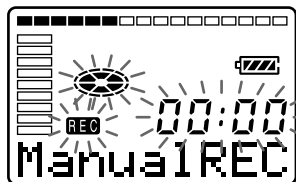

2

Checking the remaining time or the recording position

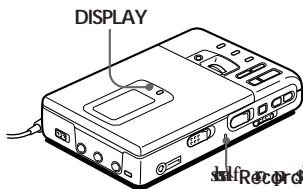

Position pointer (shows the current location on the MD)

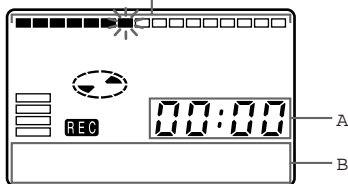

While recording

A	B
00:00	00:00
00:00	00:00
00:00	00:00

In stop mode

A	B
00:00	00:00
00:00	00:00
00:00	00:00
00:00	00:00

To know the recording condition

Recording condition	Record indicator
00:00	00:00
00:00	00:00
00:00	00:00
00:00	00:00

Setting the clock to stamp the recorded time

1

2

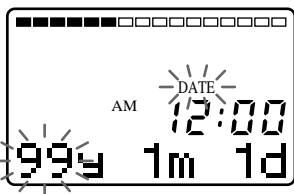

3

4

5

If you make a mistake while setting the clock

To display the current time

To display the time in the 24-hour system

CLOCK SET
(on the bottom)

z Various ways of playback

Selecting the track number or track name directly

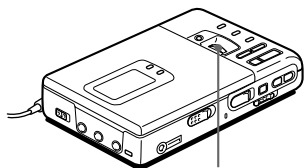

Vertical jog dial

Playing tracks repeatedly

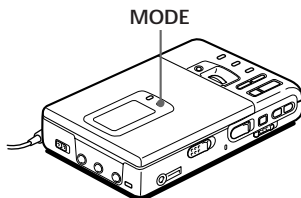

Rotate to select.



Press to play.

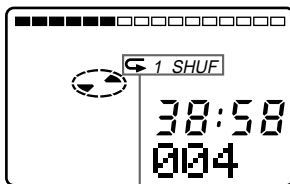

Play mode indication

Indication	Play mode
ea skat et IA	
"f " ea skat et IA	
"f 1" si lat et A	
SHUF et IA	

ea skat et IA	
"f " ea skat et IA	
"f 1" si lat et A	
SHUF et IA	

Emphasizing bass (DIGITAL MEGA BASS)

Protecting your hearing (AVLS)

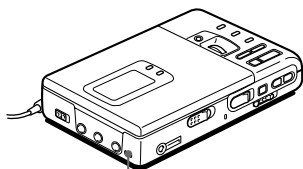

DIGITAL MEGA BASS

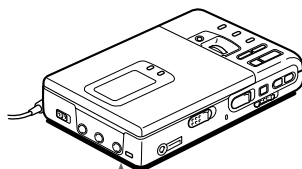

AVLS

1

Mega Bass indication
is shown when the
Mega Bass function is
activated.

1

AVLS indication
is shown when the
AVLS function is
activated.

Mega Bass indication

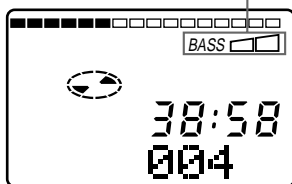

Indication	Play mode
BASS	
BASS	

Notes

1. The Mega Bass function is not available when the device is in the standby mode.
2. The Mega Bass function is not available when the device is in the playback mode.
3. The Mega Bass function is not available when the device is in the recording mode.
4. The Mega Bass function is not available when the device is in the editing mode.

Checking the remaining time or the playing position

Locking the controls

1. Press the **HOLD** button on the front panel of the MD.

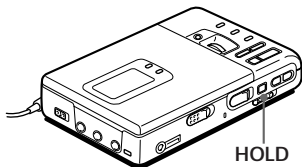
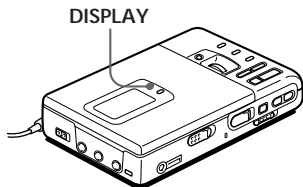

Position pointer (shows the current location on the MD)

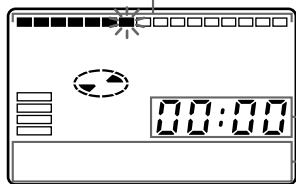

1. Press the **HOLD** button on the remote control.

A	B
00:00	00:00
00:00	00:00
00:00	00:00
00:00	00:00
00:00	00:00

Connecting to a stereo system

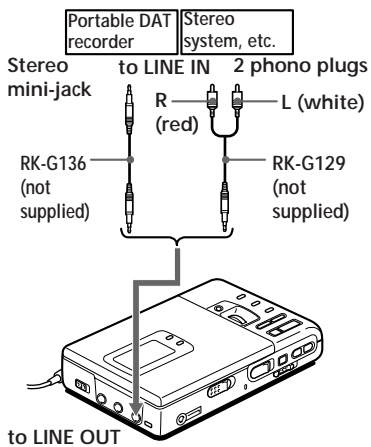

Note

z *Editing recorded tracks*

You can edit your recordings by adding/erasing track marks or labeling tracks and MDs. Premastered MDs cannot be edited.



- Do not move or jog the recorder while "Toc Edit" is flashing in the display.
- You cannot edit tracks on an MD that is record-protected. Before editing tracks, close the tab on the side of the MD.

Erasing tracks

To erase a track

Note that once a recording has been erased, you cannot retrieve it. Check the track number before erasing.

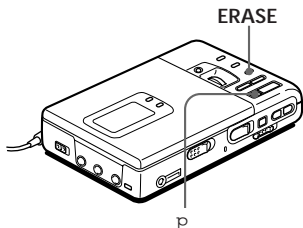

- 1 Press ERASE while playing the track you want to erase. "Erase OK?" and "Push Erase" appear in the display alternately, and the recorder plays the selected track repeatedly. To cancel erasing, press P.
- 2 Check the track number in the display and press ERASE again. The track is erased from the MD and the remaining tracks are renumbered.



Add track marks at the beginning and the end of the part you want to erase, then erase the part.

To erase the whole disc

You can quickly erase all the tracks and data of the MD at the same time. Note that once a recording has been erased, you cannot retrieve it. Be sure to check the contents of the disc you want to erase.

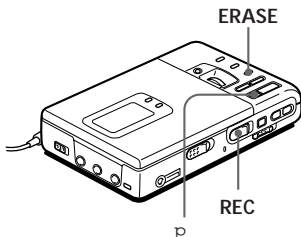

- 1 In stop mode, keep pressing ERASE and slide REC to the right. "All Erase?" and "Push Erase" appear in the display alternately. To cancel erasing, press P.
- 2 Press ERASE again. "Toc Edit" flashes in the display. When erasing finishes, "BLANK DISC" appears.

Adding a track mark

You can add track marks so that the separated part after the track mark is as a new track.

The track numbers will increase as follows.

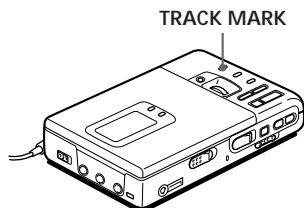
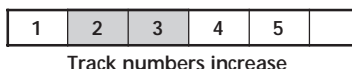
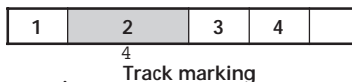

- 1 While playing or pausing an MD, press TRACK MARK on the recorder at the point you want to mark. "MARK ON" appears in the display, and a track mark is added. The track number will increase by one.



Press TRACK MARK on the recorder or the remote commander.



TRACK MARK on the remote controller does not function during playback.

Erasing a track mark

When you record with analog (line) input, unnecessary track marks may be recorded. You can erase a track mark to combine the tracks before and after the track mark. The track numbers will change as follows.

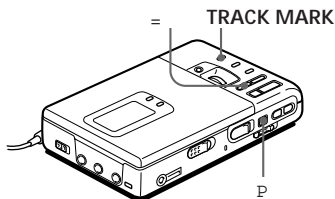
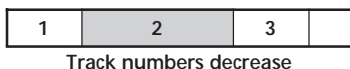
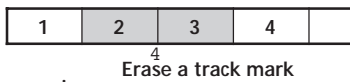

- 1 While playing the track with the track mark you want to erase, press P to pause.
- 2 Find the track mark by pressing = slightly.
For example, to erase the third track mark, find the beginning of the third track. "00:00" appears in the display.
- 3 Press TRACK MARK to erase the mark.
"MARK OFF" appears in the display. The track mark is erased and the two tracks are combined.

Z

The combined track whose mark has been erased is recorded with the date and time of the beginning of the first of the two combined tracks.

Moving recorded tracks

You can change the order of the recorded tracks.

Before moving

Track A	Track B	Track C	Track D	
1	2	3	4	

After moving

Track A	Track C	Track B	Track D	
1	2	3	4	

Move track C from the third to the second track.

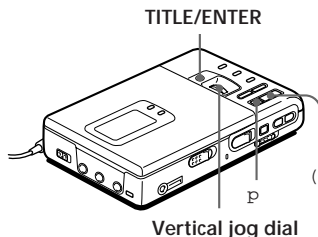

- 1 While playing, keep pressing (and press TITLE/ENTER. The recorder plays the selected track repeatedly. For example above, "MV003n003" appears in the display.
- 2 Rotate the vertical jog dial to select the new track position. For example above, rotate the jog dial until "MV003n002" appears in the display. To cancel moving, press p .
- 3 Press TITLE/ENTER again. Moving is completed and the recorder plays the moved track.

z
You can also move the track by pressing the jog dial in step 3.

Labeling recordings

You can label the MDs and tracks you recorded with letters, numbers, and marks. Each label can be made up of up to 200 characters, and each MD can hold up to 1700 characters.

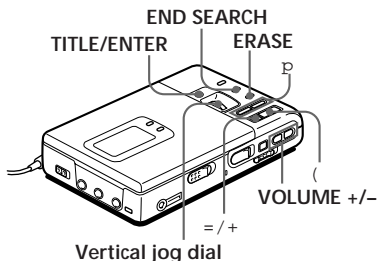

- 1 To label a track , play the track you want to label. To label an MD, insert the recordable MD you want to label. If an MD is already inserted, press p to stop.
- 2 Press TITLE/ENTER. If you have selected a track in step 1 above, the recorder will play that track repeatedly. A cursor flashes in the display.
- 3 Use the vertical jog dial to select and enter a character.

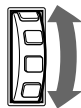

Rotate to select.



Press to enter.

Rotate the jog dial to select a character, and press the jog dial to enter the selected character. The cursor shifts rightward and stands by for the input of the next character.

Press	To
(Select the first of capital letters, small letters, and numbers quickly.
=/+	Move the cursor to the left or right.
END SEARCH	Insert a space.
ERASE	Delete a character.
P	Cancel labeling.

4 Repeat step 3 until you have entered all the characters for the label.

5 Press TITLE/ENTER.
Labeling is completed.

- Capital and small letters of the English alphabet
- Numbers 0 to 9
- ! " # \$ % & () * + - . ; < = > ?
@ _ ` ' , / : _ (space)

Do steps 1 and 2 to display the label of the track or MD. Enter a new character over the one you want to change, then press TITLE/ENTER.



- You cannot relabel premastered MDs or label MDs that have not been recorded.
- The recorder is able to display Japanese “Katakana” characters. But you cannot label with them on this recorder.

z **Power sources**

You can use the recorder on house current or as follows.

In the recorder ...

- a lithium ion rechargeable battery (supplied)

With supplied battery case ...

- dry batteries (not supplied)

It is preferable to use the recorder on house current when recording for a long time.

Using on a lithium ion rechargeable battery

Before using the supplied LIP-12(H) lithium ion rechargeable battery for the first time, charge it in the recorder.

- 1 Connect the supplied AC power adaptor.

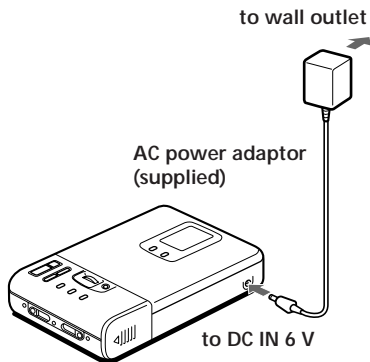

- 2 Insert the LIP-12(H) into the recorder and close the lid.

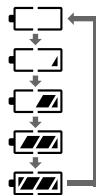
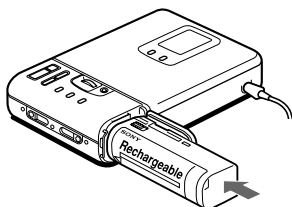

Battery indication appears in the display and charging starts. When charging is completed, battery indication disappears.

Charging time

To charge a completely discharged battery, it takes the following time.

80%	Approx. 2.5 hours
100%	Approx. 5 hours

z

You can use the recorder while charging.

Notes

- Be sure to use the supplied AC power adaptor.
- Charging time may vary depending on the battery condition.

Using on dry batteries

- 1 Attach the supplied battery case.

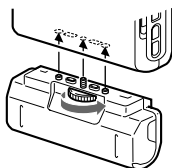

- 2 Insert two LR6 (size AA) dry batteries (not supplied).

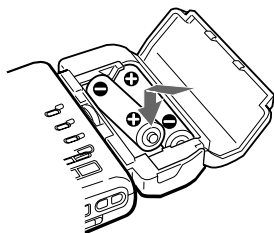

Battery life¹⁾

Batteries	Recording ²⁾	Playback
LIP-12(H) lithium ion rechargeable battery	Approx. 5 hours	Approx. 8 hours
Two LR6 (size AA) Sony alkaline dry batteries	----- ³⁾	Approx. 6.5 hours
LIP-12(H) + Two LR6 (size AA)	----- ³⁾	Approx. 15 hours

¹⁾The battery life may be shorter due to operating conditions and the temperature of the location.

²⁾When you record, use a fully charged rechargeable battery.

³⁾Recording time may differ according to the alkaline batteries.

When to replace the batteries

When the dry batteries or rechargeable battery are weak, flashing b or "LOW BATT" appear in the display. Replace the dry batteries or charge the rechargeable battery.

Precautions

On safety

Do not put any foreign objects in the DC IN 6 V jack.

On power sources

- Use house current, lithium ion rechargeable battery, two LR6 (size AA) batteries, or car battery.
- For use in your house: Use the AC power adaptor supplied with this recorder. Do not use any other AC power adaptor since it may cause the recorder to malfunction.

Polarity of the plug



- The recorder is not disconnected from the AC power source (mains) as long as it is connected to the wall outlet, even if the recorder itself has been turned off.
- If you are not going to use this recorder for a long time, be sure to disconnect the power supply (AC power adaptor, dry batteries, rechargeable battery, or car battery cord). To remove the AC power adaptor from the wall outlet, grasp the adaptor plug itself; never pull the cord.
- For use in the car: Use the CPA-9 car connecting pack and the DCC-E260 car battery cord (not supplied).

On heat build-up

Heat may build up in the recorder if it is used for an extended period of time. In this case, leave the recorder turned off until it cools down.

On installation

- Never use the recorder where it will be subjected to extremes of light, temperature, moisture or vibration.
- Never wrap the recorder in anything when it is being used with the AC power adaptor. Heat build-up in the recorder may cause malfunction or damage.

On the headphones

Road safety

Do not use headphones while driving, cycling, or operating any motorized vehicle. It may create a traffic hazard and is illegal in many areas. It can also be potentially dangerous to play your recorder at high volume while walking, especially at pedestrian crossings. You should exercise extreme caution or discontinue use in potentially hazardous situations.

Preventing hearing damage

Avoid using headphones at high volume. Hearing experts advise against continuous, loud and extended play. If you experience a ringing in your ears, reduce the volume or discontinue use.

Caring for others

Keep the volume at a moderate level. This will allow you to hear outside sounds and to be considerate of the people around you.

On the MiniDisc cartridge

- Do not break open the shutter.
- Do not place the cartridge where it will be subject to light, extreme temperatures, moisture or dust.

On cleaning

- Clean the recorder casing with a soft cloth slightly moistened with water or a mild detergent solution. Do not use any type of abrasive pad, scouring powder or solvent such as alcohol or benzene as it may mar the finish of the casing.
- Wipe the disc cartridge with a dry cloth to remove dirt.
- Dust on the lens may prevent the unit from operating properly. Be sure to close the disc compartment lid after inserting and ejecting an MD.

Notes on batteries

Incorrect battery usage may lead to leakage of battery fluid or bursting batteries. To prevent such accidents, observe the following precautions:

- Install the + and - poles of the batteries correctly.
- Do not install new and used batteries or different kinds of batteries together.
- Do not try to recharge dry batteries.
- When the recorder is not to be used for a long time, be sure to remove the batteries.
- If a battery leak should develop, carefully and thoroughly wipe away battery fluid from the battery compartment before inserting new ones.

For customers in the USA

DISPOSAL OF LITHIUM ION BATTERY.

LITHIUM ION BATTERY. DISPOSE OF PROPERLY.

You can return your unwanted lithium ion batteries to your nearest Sony Service Center.

Note: In some areas the disposal of lithium ion batteries in household or business trash may be prohibited.

For the Sony Service Center nearest you call 1-800-222-SONY (United States only)

Caution: Do not handle damaged or leaking lithium ion battery.

Note on mechanical noise

The recorder produces out mechanical noise while operating, which is caused by the power-saving system of the recorder and it is not a problem.

To protect a recorded MD

To record-protect an MD, slide open the tab at the side of the MD. In this position, the MD cannot be recorded. To record again, slide the tab back so the tab is visible.

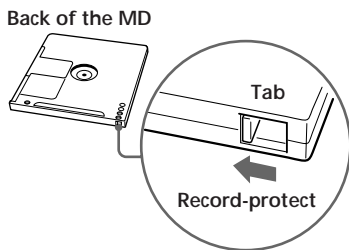

Note on digital recording

This recorder uses the Serial Copy Management System, which allows only first-generation digital copies to be made of premastered software. You can only make copies from a home-recorded MD by using the analog (line out) connections.

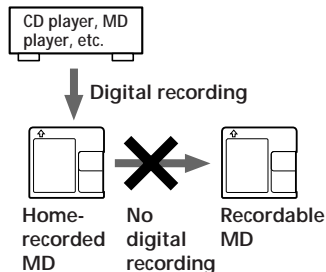

If you have any questions or problems concerning your recorder, please consult your nearest Sony dealer.

Troubleshooting

Should any problem persists after you have made these checks, consult your nearest Sony dealer.

Symptom	Cause/Solution
The recorder does not work or works poorly.	<ul style="list-style-type: none">• Audio sources may not be securely connected.<ul style="list-style-type: none">↳ Disconnect the audio sources once and connect them again (pages 6,11).• Moisture has condensed inside the recorder.<ul style="list-style-type: none">↳ Take the MD out and leave the recorder in a warm place for several hours until the moisture evaporates.• The rechargeable battery or dry batteries are weak (↳ or "LOW BATT" flashes).<ul style="list-style-type: none">↳ Charge the rechargeable battery or replace the dry batteries (pages 24, 25).• The rechargeable battery or dry batteries have been installed incorrectly.<ul style="list-style-type: none">↳ Install the batteries correctly (page 25).• You pressed a button while the disc indication was rotating quickly.<ul style="list-style-type: none">↳ Wait until the indication rotates slowly.• The recording volume is too low.• The recording was made using a connecting cord with an attenuator.<ul style="list-style-type: none">↳ Use a connecting cord without an attenuator (page 6).• The AC adaptor was unplugged during recording or a power outage occurred.• While operating, the recorder received a mechanical shock, too much static, abnormal power voltage caused by lightning, etc.<ul style="list-style-type: none">↳ Restart the operation as follows.<ol style="list-style-type: none">1 Disconnect all the power sources.2 Leave the recorder for about 30 seconds.3 Connect the power source.
No sound comes through the headphones.	<ul style="list-style-type: none">• The headphones plug is not firmly connected.<ul style="list-style-type: none">↳ Connect the headphones with a remote controller plug firmly to 2 /REMOTE.• Volume is too low.<ul style="list-style-type: none">↳ Adjust the volume by pressing VOLUME +/- (VOL +/- on the remote controller).• AVLS is on.<ul style="list-style-type: none">↳ Slide AVLS to NORMAL (page 17).

Symptom	Cause/Solution
An MD is not played from the first track.	<ul style="list-style-type: none"> • Disc playing stopped before it came to the last track. <ul style="list-style-type: none"> ↳ Press = repeatedly or open and close the lid once to go back to the beginning of the disc, and restart playing after checking the track number in the display.
Playback sound skips.	<ul style="list-style-type: none"> • The recorder is placed where it receives continuous vibration. <ul style="list-style-type: none"> ↳ Put the recorder on a stable place. • A very short track may cause sound to skip.
Sound has a lot of static.	<ul style="list-style-type: none"> • Strong magnetism from a television or such device is interfering with operation. <ul style="list-style-type: none"> ↳ Move away from the source of strong magnetism.
Cannot find the track marks.	<ul style="list-style-type: none"> • You pressed P after pressing = or + . <ul style="list-style-type: none"> ↳ Press P before pressing = or + .
Charging the rechargeable battery does not start.	<ul style="list-style-type: none"> • The rechargeable battery has been inserted incorrectly or the AC power adaptor has been connected incorrectly. <ul style="list-style-type: none"> ↳ Insert the battery correctly or connect the AC power adaptor correctly.
<p>The clock loses time or the display flashes.</p> <p>The recording date was not stamped onto the disc.</p>	<ul style="list-style-type: none"> • The built-in battery for a clock is weak. <ul style="list-style-type: none"> ↳ Connect the AC power adaptor to DC IN 6 V on the recorder and the wall outlet to charge the built-in battery. After charging, set the clock again. Note that the clock normally loses about 2 minutes per month (page 15).

System limitations

The recording system in your MiniDisc recorder is radically different from those used in cassette and DAT decks and is characterized by the limitations described below. Note, however, that these limitations are due to the inherent nature of the MD recording system itself and not to mechanical causes.

Symptom	Cause
"TR FULL" appears even before the disc has reached the maximum recording time (60 or 74 minutes).	When 254 tracks have been recorded on the disc, "TR FULL" appears regardless of the total recorded time. More than 254 tracks cannot be recorded on the disc. To continue recording, erase unnecessary tracks.
"TR FULL" appears even before the disc has reached the maximum track number or recording time.	Repeating recording and erasing may cause fragmentation and scattering of data. Although those scattered data can be read, each fragment is counted as a track. In this case, the number of tracks may reach 254 and further recording is not possible. To continue recording, erase unnecessary tracks.
Track marks cannot be erased.	When the data of a track is fragmented, the track mark of a fragment under 12 seconds long cannot be erased.
The remaining recording time does not increase even after erasing numerous short tracks.	Tracks of under 12 seconds in length are not counted and so erasing them may not lead to an increase in the recording time.
The total recorded time and the remaining time on the disc may not total the maximum recording time (60 or 74 minutes).	Recording is done in minimum units of 2 seconds each, no matter how short the material. Even if the last unit of recording is less than 2 seconds, it is counted as a unit of 2 seconds. Then 2 seconds' space is put before recording starts again to prevent the last unit of the previous track from being erased. The contents recorded may thus be shorter than the maximum recording capacity.
The edited tracks may exhibit sound dropout during search operations.	The fragmentation of data may cause sound dropout while searching because the tracks are played in higher speed than normal playback.

Error messages

If the following error messages flash in the display window, check the chart below.

Error message	Meaning/Remedy
BLANKDISC	<ul style="list-style-type: none">• An MD with no recording on it is inserted.<ul style="list-style-type: none">↳ Insert a recorded MD.
DISC ERR	<ul style="list-style-type: none">• The recorder cannot read the disc (it's scratched or dirty).<ul style="list-style-type: none">↳ Reinsert or replace the disc.
DISC FULL	<ul style="list-style-type: none">• There is no more space to record on the disc (less than 12 seconds available).<ul style="list-style-type: none">↳ Replace the disc.
BUSY	<ul style="list-style-type: none">• You tried to operate the recorder while it was accessing the recorded data.<ul style="list-style-type: none">↳ Wait until the message goes out (in rare cases, it may take 2–3 minutes).
NAME FULL	<ul style="list-style-type: none">• You tried to enter more than 200 characters for a track or disc name or the total characters entered in an MD is more than 1700.<ul style="list-style-type: none">↳ Enter the characters within the limit.
Hi DC in	<ul style="list-style-type: none">• Power supply is too high (The supplied AC power adaptor or the recommended car battery cord is not used).<ul style="list-style-type: none">↳ Use the supplied AC power adaptor or the recommended car battery cord.
HOLD	<ul style="list-style-type: none">• The recorder is locked.<ul style="list-style-type: none">↳ Slide HOLD against the allow to unlock the recorder (page 18).
LOW BATT	<ul style="list-style-type: none">• Batteries are weak.<ul style="list-style-type: none">↳ Charge the rechargeable battery or replace the dry batteries (pages 24, 25).
MEM OVER	<ul style="list-style-type: none">• You tried to record when there is no indication in the display, and the recorder is placed where it receives continuous vibration.<ul style="list-style-type: none">↳ Put the recorder on the stable place, and start recording again.
NO COPY	<ul style="list-style-type: none">• You tried to make a copy from a disc that is protected by the Serial Copy Management System. You cannot make copies from a digitally connected source which was itself recorded using the digital connection.<ul style="list-style-type: none">↳ Use the analog connection instead (page 6).
NO DISC	<ul style="list-style-type: none">• You tried to play or record with no disc in the recorder.<ul style="list-style-type: none">↳ Insert an MD.

Error message	Meaning/Remedy
NO SIGNAL	<ul style="list-style-type: none"> • The recorder could not detect digital input signals. <ul style="list-style-type: none"> ↳ Make sure that the source is connected firmly (page 11). • If the error message appears while recording, press p to stop recording.
PB ONLY	<ul style="list-style-type: none"> • You tried to record or edit on a premastered MD (PB means playback.) <ul style="list-style-type: none"> ↳ Insert a recordable MD.
PROTECTED	<ul style="list-style-type: none"> • You tried to record or edit on a MD with the tab in the record-protect position. <ul style="list-style-type: none"> ↳ Slide the tab back (page 27).
SORRY	<ul style="list-style-type: none"> • You tried to erase a track mark while playing the MD or at the beginning of the first track. • You tried to erase a track mark to combine tracks the recorder cannot combine. (caused by system limitation)
TEMP OVER	<ul style="list-style-type: none"> • Heat has built up in the recorder. <ul style="list-style-type: none"> ↳ Let the recorder cool down.
TR FULL	<ul style="list-style-type: none"> • There is no more space for new data when you are editing the MD. <ul style="list-style-type: none"> ↳ Erase unnecessary tracks (page 20).
TrPROTECT	<ul style="list-style-type: none"> • You tried to record or edit on a track that is protected from erasing. <ul style="list-style-type: none"> ↳ Record or edit on other tracks.

Specifications

System

Audio playing system

MiniDisc digital audio system

Laser diode properties

Material: GaAlAs

Wavelength: $\lambda = 780 \text{ nm}$

Emission duration: continuous

Laser output: less than $44.6 \mu\text{W}$

(This output is the value measured at a distance of 200 mm from the lens surface on the optical pick-up block.)

Recording and playback time

Maximum 74 minutes (MDW-74, stereo recording)

Maximum 148 minutes (MDW-74, monaural recording)

Revolutions

400 rpm to 900 rpm (CLV)

Error correction

Advanced Cross Interleave Reed Solomon

Code (ACIRC)

Sampling frequency

44.1 kHz

Sampling rate converter

Input: 32 kHz/44.1 kHz/48 kHz

Coding

Adaptive Transform Acoustic Coding (ATRAC)

Modulation system

EFM (Eight to Fourteen Modulation)

Number of channels

2 stereo channels

1 monaural channel

Frequency response

20 to 20,000 Hz $\pm 3 \text{ dB}$

Wow and Flutter

Below measurable limit

Inputs

Microphone: stereo mini-jack, 0.22 – 0.78 mV

Line in: stereo mini-jack, 69 – 194 mV

Optical (Digital) in: optical (digital) mini-jack

Outputs

Headphones: stereo mini-jack, maximum output level 5 mW+ 5 mW, load impedance 16 ohm

Line out: stereo mini-jack, 194 mV, load impedance 10 kilohm

General

Power requirements

Sony AC Power Adaptor (supplied) connected at the DC IN 6 V jack:

120 V AC, 60 Hz (US model)

230–240 V AC, 50/60 Hz (UK model)

240 V AC, 50/60 Hz (Australia and New Zealand model)

100-240 V AC, 50/60 Hz (Other models)

Lithium ion rechargeable battery LIP-12(H) (supplied)

Two LR6 (size AA) alkaline batteries (not supplied)

Battery operation time

See "Battery life" (page 25)

Dimensions

Approx. $116.5 \times 26 \times 78 \text{ mm}$ (w/h/d)

($4 \frac{5}{8} \times 1 \frac{1}{16} \times 3 \frac{1}{8} \text{ in.}$)

Mass

Approx. 220 g (7.1 oz) the recorder only

Approx. 364 g (11.7 oz) for US model, 317 g (10.2 oz) for other models ; incl. a recordable

MD, headphones with a remote controller, and LIP-12 lithium ion rechargeable battery

Supplied accessories

AC power adaptor (1)

Headphones with a remote controller (1)

LIP-12(H) lithium ion rechargeable battery (1)

Ear pads (2)(Except for US model)

Carrying case (1)

Dry battery case (1)

Optional accessories

Lithium ion rechargeable battery LIP-12

Micro plug adaptor (Stereo mini plug n

Micro plug) PC-MP1HG

Optical Cable

POC-151HG, POC-152HG, POC-MZ1,

POC-MZ2, POC-15B, POC-15AB, POC-

DA12S

Line Cable RK-G129, RK-G136

Car Connecting Pack CPA-9

Car Battery Cord DCC-E260

Stereo Microphones ECM-MS907, ECM-

909A, ECM-717

Stereo Headphones MDR-D77, MDR-D55

Active Speakers SRS-A41, SRS-A91

Recordable MDs MDW-74/74A, MDW-74L/

74R/74Y, MDW-60/60A

MiniDisc Carrying Case CK-MD4

MiniDisc Filing Box CK-MD10

Your dealer may not handle some of the above listed accessories. Please ask the dealer for detailed information about the accessories in your country.

US and foreign patents licensed from Dolby Laboratories Licensing Corporation.

Design and specifications are subject to change without notice.

What is MD?

How MiniDisc works

MiniDisc (MD) comes in two types: premastered (prerecorded) and recordable (blank). Premastered MDs, recorded at music studios, can be played back almost endlessly. However, they can't be recorded on or over like cassette tapes. To record, you must use a "recordable MD".

Premastered MDs

Premastered MDs are recorded and played like regular CDs. A laser beam focuses on the pits in the surface of the MD and reflects the information back to the lens in the recorder. The recorder then decodes the signals and plays them back as music.

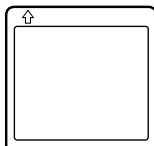

Recordable MDs

Recordable MDs, which use magneto-optical (MO) technology, can be recorded again and again. The laser inside the recorder applies heat to the MD, demagnetizing the magnetic layer of the MD. The recorder then applies a magnetic field to the layer. This magnetic field corresponds exactly to the audio signals generated by the connected source. (The north and south polarities equate to digital "1" and "0".) The demagnetized MD adopts the polarity of the magnetic field, resulting in a recorded MD.

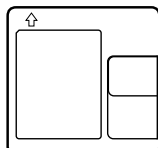

How the MiniDisc got so small

The 2.5-inch MiniDisc, encased in a plastic cartridge that looks like a 3.5-inch diskette (see illustration below), uses a new digital audio compression technology called ATRAC (Adaptive Transform Acoustic Coding). To store more sound in less space, ATRAC extracts and encodes only those frequency components actually audible to the human ear.

Quick Random Access

Like CDs, MDs offer instantaneous random access to the beginning of any music track. Premastered MDs are recorded with location addresses corresponding to each music selection. Recordable MDs are manufactured with a "User TOC Area" to contain the order of the music. The TOC system is similar to the "directory management system" of floppy disks. In other words, starting and ending addresses for all music tracks recorded on the disc are stored in this area. This lets you randomly access the beginning of any track as soon as you enter the track number (AMS), as well as label the location with a track name as you would a file on a diskette.

Shock-Resistant Memory

One major drawback of optical read systems is that they can skip or mute when subjected to vibration. The MD system resolves this problem by using a buffer memory that stores audio data.

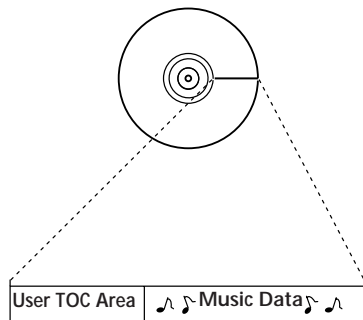

Contains the order and start/end points of the music.

Looking at the controls

See pages in () for more details.

The recorder

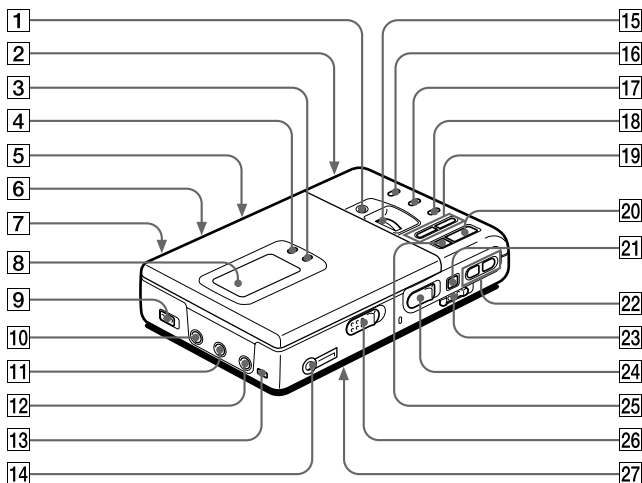

- 1 TITLE/ENTER button(22)
- 2 Battery compartment (on the bottom) (24)
- 3 MODE button (16)
- 4 DISPLAY button (14, 18)
- 5 MIC SENS switch (on the bottom) (12)
- 6 AVLS switch (on the bottom) (17)
- 7 DC IN 6V jack (at the rear) (6)
- 8 Display window (14,18)
- 9 SYNCHRO REC (synchro-recording) switch (11)
- 0 MIC (PLUG IN POWER) jack (12)
- ! LINE IN (OPTICAL) jack (6, 11)
- ! " LINE OUT jack (19)
- ! ₤DIGITAL MEGA BASS button (17)
- ! ♡2 (headphones)/REMOTE jack (8)
- !∞ Vertical jog dial (16, 22)
- ! /TRACK MARK button (21)
- ! ♪END SEARCH button (7)
- ! ¥ERASE button (20)
- ! ⌘/+ (search /AMS) button (7, 9)
- @... (play) button (7, 9)
- @ ` P (pause) button (7, 9)
- @ VOLUME +/- button (9)
- @£ HOLD switch (18)
- @¢ REC (record) switch (7)
- @∞ p (stop) button (7, 9)
- @/ OPEN button (6)
- @f CLOCK SET button (on the bottom) (15)

The display window

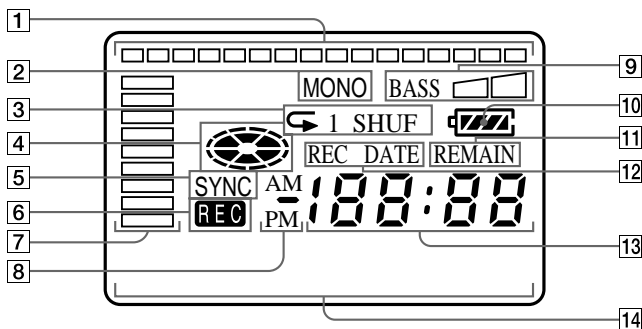

- 1 Position indicator (14, 18)
Shows the current location on the MD. The point under recording or playing flashes. The recorded portion lights up.

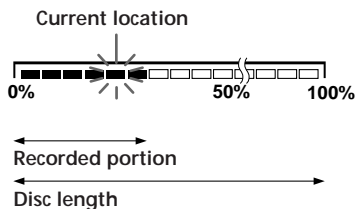

- 2 MONO (monaural) indication
3 Play mode indication
Shows the play mode of the MD.
4 Disc indication
Shows that the disc is rotating for recording, playing or editing an MD.
5 SYNC (synchro-recording) indication
6 REC indication (7)
Lights up while recording. When flashing, the recorder is in record standby mode.

- 7 Level meter
Shows the volume of the MD being played or recorded.
8 AM/PM indication (15)
Lights up along with the time indication in the 12-hour system.
9 Mega bass indication (17)
0 Battery indication (24)
Shows battery condition.
! REMAIN (remaining time/tracks) indication (14,18)
Lights up along with the remaining time of the track, the remaining time of the MD, or the remaining number of tracks.
! * REC DATE (recorded/current date) indication
Lights up along with the date and time the MD was recorded. When only "DATE" lights up, the current date and time are displayed.
! £ Time display (14, 15, 18)
Shows the recorded time, current time, elapsed time of the track or MD being recorded or played.
! ¤ Character information display (14,18)
Displays the disc and track names, date, error messages, track numbers, etc.

The headphones with a remote controller

1

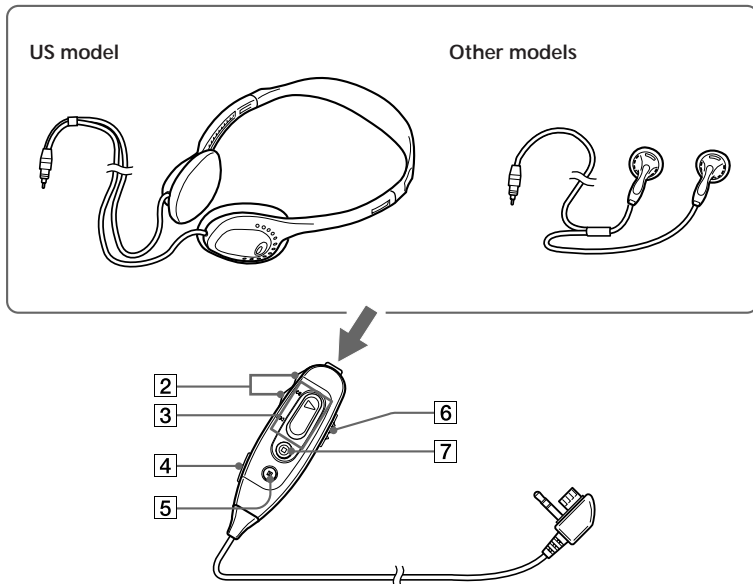

- 1 Headphones
Can be replaced with optional headphones.
- 2 VOL (volume) +/- buttons (9)
- 3 (play)/= /+ (search, AMS) buttons
Press (to play. While playing, press the = side to find beginning of the current or preceding tracks or to search backward, or press the + side to find the beginning of the succeeding tracks or to search forward.
- 4 TRACK MARK button (21)
- 5 P (pause) button (7,9)
- 6 HOLD switch (18)
Slide to lock the controls of the remote controller.
- 7 p (stop) button (7,9)

