

CD Clock Radio

Operating Instructions

ICF-CD810

Sony Corporation © 1995 Printed in Malaysia

Owner's Record

The model number and the serial number are located on the rear. Record the serial number in the space provided below. Refer to these numbers whenever you call upon your Sony dealer regarding this product.

Model No. ICF-CD810 Serial No. _____

WARNING

To prevent fire or shock hazard, do not expose the unit to rain or moisture.

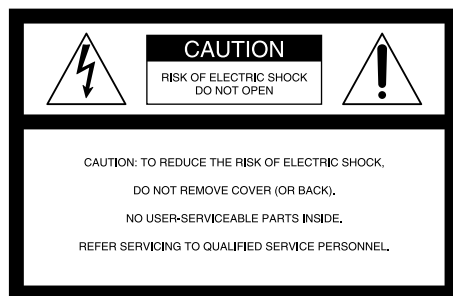

This symbol is intended to alert the user to the presence of uninsulated "dangerous voltage" within the product's enclosure that may be of sufficient magnitude to constitute a risk of electric shock to persons.



This symbol is intended to alert the user to the presence of important operating and maintenance (servicing) instructions in the literature accompanying the appliance.

* The graphical symbols are on the bottom enclosure.

You are cautioned that any changes or modifications not expressly approved in this manual could void your authority to operate this equipment.

INFORMATION

This equipment has been tested and found to comply with the limits for a Class B digital device, pursuant to Part 15 of the FCC Rules. These limits are designed to provide reasonable protection against harmful interference in a residential installation. This equipment generates, uses, and can radiate radio frequency energy and, if not installed and used in accordance with the instructions, may cause harmful interference to radio communications. However, there is no guarantee that interference will not occur in a particular installation. If this equipment does cause harmful interference to radio or television reception, which can be determined by turning the equipment off and on, the user is encouraged to try to correct the interference by one or more of the following measures:

- Reorient or relocate the receiving antenna.
- Increase the separation between the equipment and receiver.
- Connect the equipment into an outlet on a circuit different from that to which the receiver is connected.
- Consult the dealer or an experienced radio/TV technician for help.

CAUTION

The use of optical instruments with this product will increase eye hazard.

Before You Begin

Thank you for choosing the Sony CD clock radio! The CD clock radio will give you many hours of reliable service and listening pleasure. Before operating the CD clock radio, please read these instructions thoroughly and retain them for future reference.

Features

- You can wake up to CD, radio and buzzer with the snooze function.
- You can wake up to any track on CD.
- Dual alarm
- Three-inch disc can be played without an adaptor.
- Self power back-up: Even if the power supply is interrupted, the time setting and the memory will be backed up for 1 minute without batteries.

Precautions

- Operate the unit on the power sources specified in "Specifications".
- The nameplate indicating voltage, etc. is located at the bottom.
- Disconnect the cord by grasping the plug. Never pull it by the cord.
- Do not leave the unit in a location near a heat source such as a radiator or airtuck, or in a place subject to direct sunlight, excessive dust, mechanical vibration, or shock.
- The unit is not disconnected from the AC power source (mains) as long as it is connected to the wall outlet, even if the unit itself has been turned off.
- Allow adequate air circulation to prevent internal heat build-up. Do not place the unit on a surface (a rug, a blanket, etc.) or near materials (a curtain) which might block the ventilation holes.
- Should any liquid or solid object fall into the unit, unplug the unit and have it checked by a qualified personnel before operating it further.
- When the casing becomes soiled, clean it with a soft cloth dampened with a mild detergent solution. Never use abrasive cleansers or chemical solvents, as they may mark the casing.

If you have any question, please consult your nearest Sony dealer.

Specifications

CD player section

System: Compact disc digital audio system

Laser diode properties: Material: GaAlAs

Wavelength: 780 nm

Emission duration: Continuous

Laser output: Less than 44.6 μ W*

*This output is the value measured at a distance of about 200 mm from the objective lens surface on the optical pick-up block with 7 mm aperture.

Frequency response: 20 – 20,000 Hz \pm 1.5 dB

Wow and flutter: Below measurable limit

Radio section

Frequency range:

FM: 87.5 – 108.0 MHz

AM: 530 – 1605 kHz

General

Speaker: Fullrange: 7.7 cm (3 1/8 inches) 4 ohms

Power outputs: 1.2 W + 1.2 W (at 10% harmonic distortion)

Power requirements:

120 V AC, 60 Hz

Dimensions: Approx. 286×200×104 mm (w/h/d)

(Approx. 11 3/8 × 7 7/8 × 4 1/8 inches) incl. projecting parts and controls

Mass: Approx. 1.7 kg (3 lb 12 oz)

Design and specifications are subject to change without notice.

IMPORTANT SAFEGUARDS

For your protection, please read these safety instructions completely before operating the appliance, and keep this manual for future reference. Carefully observe all warnings, precautions and instructions on the appliance and described in the operating instructions supplied with the appliance by Sony.

INSTALLATION

Water and Moisture

Do not install the appliance near water: for example, near a bathtub, washbowl, kitchen sink, laundry tub, in a wet basement, or near a swimming pool.

Heat

Do not install the appliance near sources of heat such as radiators, heat registers, stoves, or other appliances that produce heat.

Ventilation

Slots and openings in the cabinet and in the back or bottom are provided for necessary ventilation. To ensure reliable and safe operation of the appliance, and to protect it from overheating, these slots and openings must never be blocked or covered.

Do not place the appliance on a bed, sofa, rug or other similar surface which may block the slots and openings.

Do not install the appliance in a confined space, such as a bookcase or built-in cabinet, unless proper ventilation is provided.

Carts and Stands

Do not install the appliance on an unstable table, shelf, cart or stand. Use only a cart or stand recommended by Sony.

An appliance and cart combination should be moved with care. Quick stops, excessive force, and uneven surfaces may cause the appliance and cart combination to overturn.

Wall or Ceiling Mounting

If your appliance can be mounted to a wall or ceiling, mount it only as recommended by Sony.

USE

Power Source

Connect the appliance to a power supply only of the type described in the operating instructions or as marked on the appliance.

Grounding or Polarization

Do not defeat the grounding or polarization feature of the AC power cord. If your AC receptacle will not accept the power cord plug, contact your electrician to install a proper AC receptacle.

AC Receptacle

Check to make sure that the AC receptacle holds the power cord plug firmly and securely. If the power cord plug is loose, contact your electrician to replace the defective and unsafe AC receptacle.

Power-Cord Protection

Route the power cord so that it is not likely to be walked on or pinched by having objects placed on it, paying particular attention to the plugs, receptacles, and the point where the cord exits from the appliance.

When not in use

Unplug the power cord of the appliance from the outlet when left unused for a long period of time.

To disconnect the cord, pull it out by grasping the plug. Never pull the plug out by the cord.

Foreign Objects

Be careful that foreign objects and liquids do not enter the enclosure through openings.

Cleaning

Clean the appliance only as recommended by Sony.

ANTENNAS

Outdoor Antenna Grounding

If an outdoor antenna or cable system is installed, follow the precautions below. An outdoor antenna system should not be located in the vicinity of overhead power lines or other electric light or power circuits, or where it can come in contact with such power lines or circuits. WHEN INSTALLING AN OUTDOOR ANTENNA SYSTEM, EXTREME CARE SHOULD BE TAKEN TO KEEP FROM CONTACTING SUCH POWER LINES OR CIRCUITS AS CONTACT WITH THEM IS ALMOST INVARIABLY FATAL.

Be sure the antenna system is grounded so as to provide some protection against voltage surges and built-up static charges. Section 810 of the National Electrical Code provides information with respect to proper grounding of the mast and supporting structure, grounding of the lead-in wire to an antenna discharge unit, size of grounding conductors, location of antenna-discharge unit, connection to grounding electrodes, and requirements for the grounding electrode.

Antenna Grounding According to the National Electrical Code

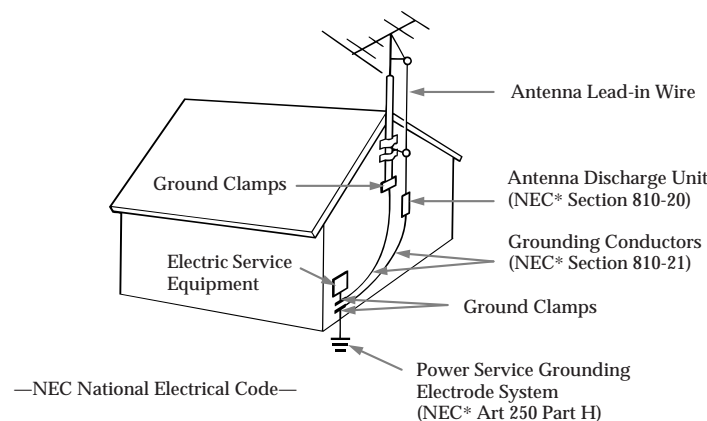

SERVICE

Unplug the appliance from the wall outlet and consult qualified service personnel when:

- the power cord or the plug has been damaged.
- a solid object or liquid has fallen into the cabinet.
- the appliance has been exposed to rain or moisture.
- the appliance does not appear to operate normally or exhibits a marked change in performance.
- the appliance has been dropped, or the enclosure damaged.

Do not attempt to service the appliance beyond that described in the operating instructions. For all other servicing refer to qualified service personnel only.

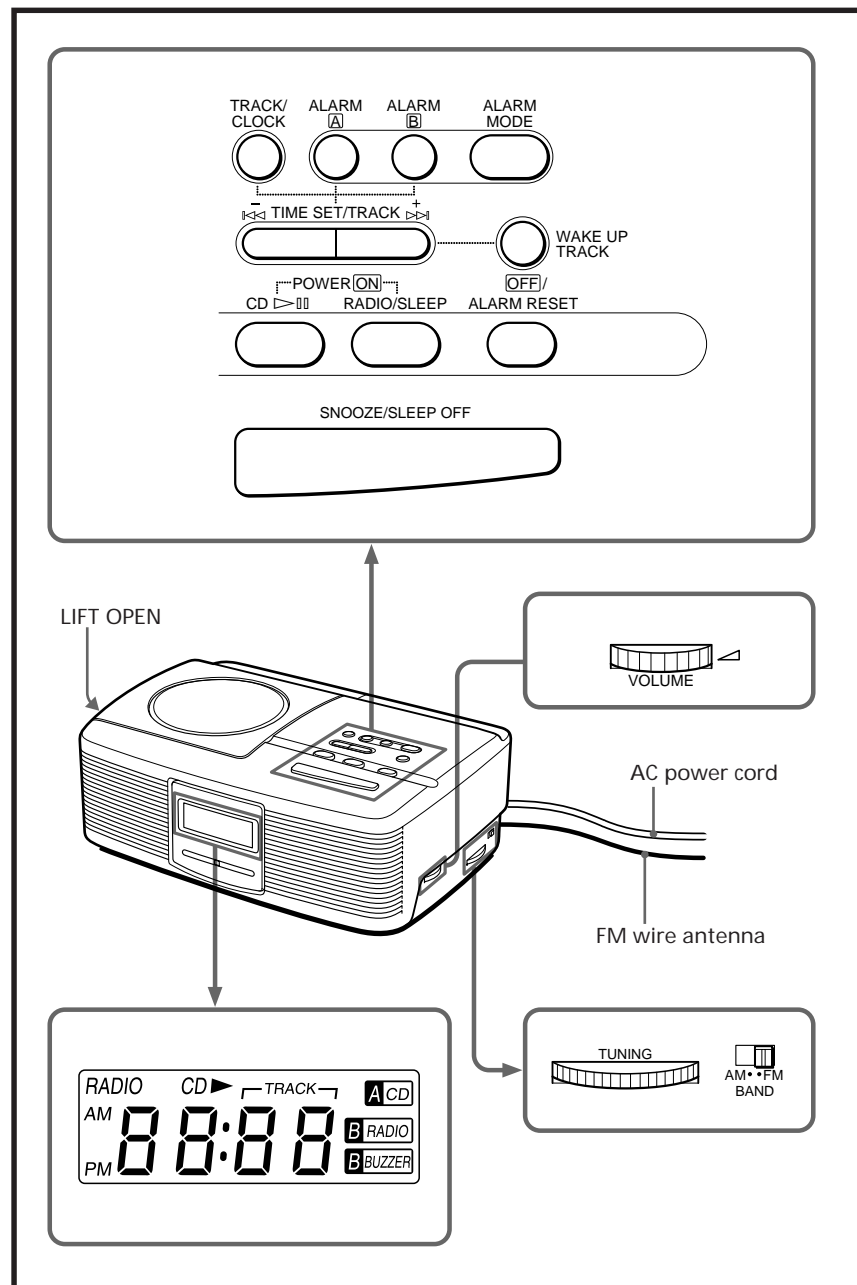

Setting the Clock

Set the time when the CD or radio is turned off.

1. Plug in the unit.
The display will flash "AM 12:00".
2. While holding down TRACK/CLOCK, press either TIME SET/TRACK + or - until the correct time appears in the display.
When you release TRACK/CLOCK, the clock begins to operate and ":" flashes.

- To set the current time rapidly, keep pressing the + or - button while holding down TRACK/CLOCK.
- To set the current time from zero seconds, at step 2, release TRACK/CLOCK with the time signal.

Playing a Disc

An 8 cm (3-inch) CD can be played without an adaptor.

1. Lift LIFT OPEN to open the CD compartment lid and place a disc.

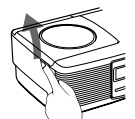

Lift.



Label surface up.



Close the lid.

2. Press CD >|| and the display lights "01". The current number (01 to 99) appears in the display window. After 10 seconds, the indication becomes the current time, but the "CD >||" indication remains.
3. Adjust VOLUME.

Locating a Particular Portion

Locating a particular selection (AMS*)

To locate the beginning of the current selection, press <<<<.

To locate the next selection, press >>>>.

Locating a particular point in a selection (SEARCH)

To go back at high speed, keep <<<< pressed.

To go ahead at high speed, keep >>>> pressed.

* AMS is the abbreviation of Automatic Music Sensor.

- If you press <<<< repeatedly, the player locates the previous selections. If you press >>>> repeatedly, the player locates the next selections and stops at the last selection.
- To stop play, press OFF/ALARM RESET.
- To pause, press CD >|| and the "CD >||" indication flashes. To resume play, press CD >|| again.
- To change the clock mode to track mode, press TRACK/CLOCK. Press TRACK/CLOCK again, and the current time appears.
- To eject a disc, lift LIFT OPEN.
- To handle compact discs

This way



Handle the disc by its edge.

Not this way

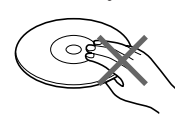

Do not touch the surface.



Do not stick paper or tape nor write anything on the surface.

Notes

- Do not open the CD compartment lid while playing, otherwise, the disc will be damaged. Be sure to stop the disc first.
- When you press CD >||, if there is no disc in the CD compartment, the "00" indication flashes for 10 seconds and the unit will be turned off.
- If the "A CD" alarm is activated while listening to the CD, the track changes to that preset by pressing WAKE UP TRACK.

Playing the Radio

1. Press RADIO/SLEEP to turn on the radio.
The "RADIO" indication will appear and the "On" indication will appear in the display. After 10 seconds, the indication becomes the current time but the "RADIO" indication remains.
2. Adjust VOLUME.
3. Select the BAND.
4. Tune in a station using the TUNING dial.

- To turn off the radio, press OFF/ALARM RESET.
- To improve radio reception
FM: Extend the FM wire antenna to improve FM reception.
AM: Rotate the unit horizontally for optimum reception. A ferrite bar antenna is built into the unit.

Setting the Alarm

You can set the CD, radio and buzzer alarms at the preset time. Before setting the alarm, be sure to set the clock. (See "Setting the Clock".)

Setting the Alarm Time

To set the "A CD" alarm

1. While holding down ALARM A, press either TIME SET/TRACK + or - until the desired time appears in the display window.
The "A CD" indication flashes and ":" lights.
2. Release ALARM A. The alarm time is set and the indication becomes the current time.
3. While holding down WAKE UP TRACK, set the desired track by pressing <<<< or >>>> beside TIME SET/TRACK.
4. Release WAKE UP TRACK. The track is preset and the indication becomes the current time.

Note

When the CD player is preset to start with track 5, it will always start with track 5 even though you change the CD, unless you change WAKE UP TRACK.

To set the "B RADIO" / "B BUZZER" alarm

1. While holding down ALARM B, press either TIME SET/TRACK + or - until the desired time appears in the display window. The "B RADIO" and "B BUZZER" indication flash and ":" lights.
2. Release ALARM B. The alarm time is set and the indication becomes the current time.

Setting the Alarm Mode

Before setting the alarm mode, be sure to set the alarm time. (See "Setting the Alarm Time".)

1. Press ALARM MODE until the alarm you want appears in the display window.
Each time you press ALARM MODE, the alarm indication changes as follows.

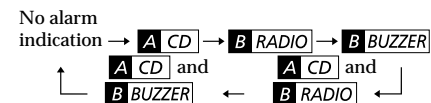

- To stop the alarm, press OFF/ALARM RESET. The alarm will sound at the same time the next day.
- To cancel the alarm, while holding down ALARM MODE, press OFF/ALARM RESET.
- To check the alarm time you set, press ALARM A or ALARM B.

Notes

- The alarm does not function, unless you set the clock and "A CD" / "B RADIO" / "B BUZZER" alarm.
- If you set the CD alarm and radio or buzzer alarm at the same time, the CD alarm sounds.
- When you set the CD alarm, if there is no disc in the CD player, the buzzer will sound at the time you set.
- The selected alarm is activated at the time you set, and automatically turns off after 60 minutes.
- When the CD alarm comes on, the "A CD" indication flashes.
If you want to stop flashing, press CD >||. The CD player will stop playing at the last track.

- When the radio alarm is activated, the "B RADIO" indication flashes. If you want to keep on listening to radio and stop flashing, press RADIO/SLEEP. The "B RADIO" indication remains.
- The buzzer sound level is fixed, and independent of VOLUME.

To Doze for a Few More Minutes

1. Press SNOOZE/SLEEP OFF. The CD, radio or buzzer will shut off but will be activated automatically after about 8 minutes. You can repeat this process as many times as necessary.

- While SNOOZE/SLEEP OFF function is operating, the alarm indication flashes.

To Use Both Sleep Timer and Alarm

You can fall asleep to the radio and you will be awakened by the CD, radio or buzzer alarm at the preset time.

1. Set the alarm. (See "Setting the Alarm".)
2. Set the sleep timer. (See "Setting the Sleep Timer".)

Setting the Sleep Timer

You can enjoy falling asleep to the radio using the built-in sleep timer that turns off the radio automatically after a preset duration.

1. Press RADIO/SLEEP repeatedly.
The radio turns on and the "On" indication will appear initially in the display. The radio will turn off automatically after the selected preset duration has elapsed.
Each time you press RADIO/SLEEP, the duration changes as follows.

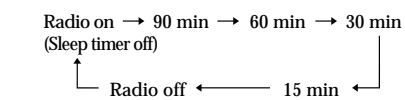

- To turn off the radio before the preset duration has elapsed, press SNOOZE/SLEEP OFF.

Troubleshooting Guide

Should any problem occur with the unit, make the following checks to determine whether or not servicing is required. If the problem persists, consult the nearest Sony dealer.

The clock does not show the correct time.

- There was an electrical power interruption lasting for more than 1 minute.

The CD player does not operate.

- Did you place a disc correctly?
The disc should be placed with the labelled surface up.
- Did you close the compartment lid completely?
- Dusty or defective disc—Clean the disc with an optional cleaning cloth. Wipe the disc from the center out.

Skipping of sound in CD operation

- Dusty or defective disc—Clean the disc.
- Dirty lens—Clean the lens with a commercially available blower.
- Strong vibration

The CD, radio or buzzer alarm does not activate at the preset time.

- Did you set the current time correctly?
- Did you set the alarm time correctly?
- Did you place a disc?
- Did you close the CD compartment lid completely?
- Did you adjust the volume?
If the volume is turned down completely, the CD or radio alarm is not heard.

LIMITED WARRANTY