

Portable CD Player

Operating Instructions



D-EJ100

©2004 Sony Corporation Printed in China

<http://www.sony.net/>

“WALKMAN” is a registered trademark of Sony Corporation to represent Headphone Stereo products. is a trademark of Sony Corporation.

CD player (front)

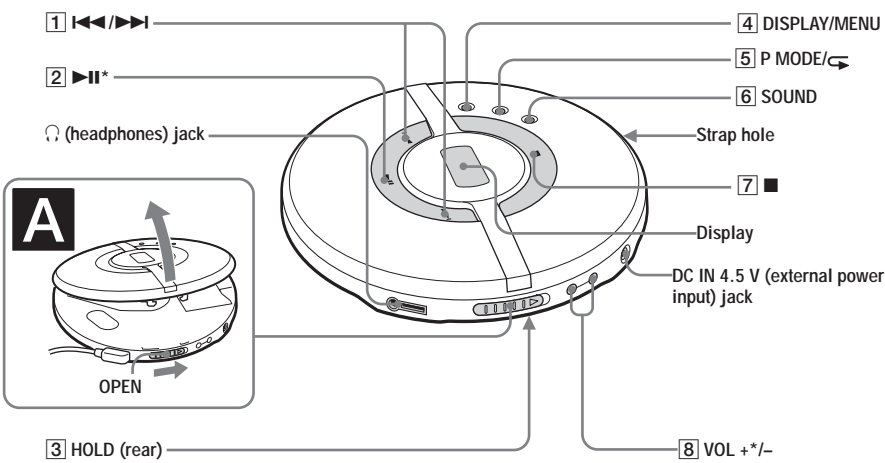

*The button has a tactile dot.

CD player (inside)

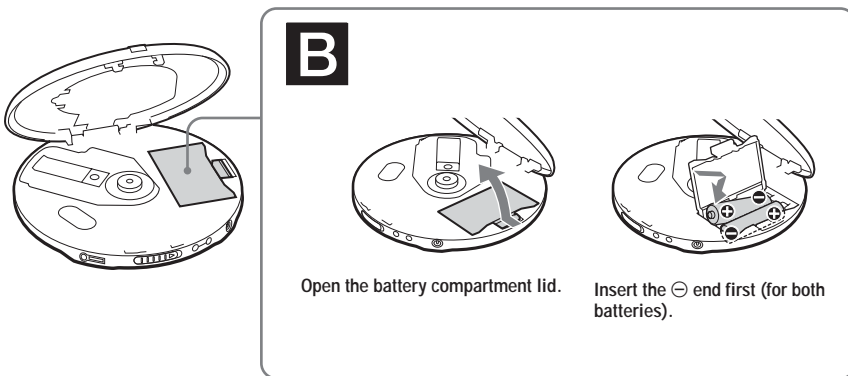

Display

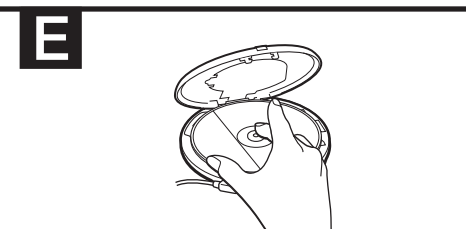
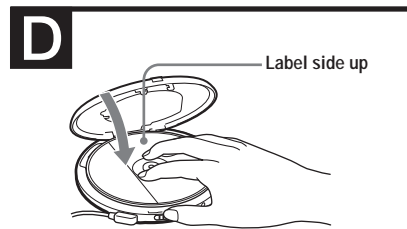
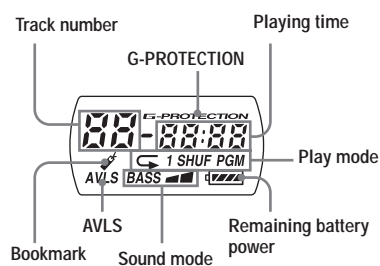

WARNING

To prevent fire or shock hazard, do not expose the unit to rain or moisture.

Do not install the appliance in a confined space, such as a bookcase or built-in cabinet.

To prevent fire, do not cover the ventilation of the apparatus with newspapers, tablecloths, curtains, etc. And don't place lighted candles on the apparatus.

To prevent fire or shock hazard, do not place objects filled with liquids, such as vases, on the apparatus.

Certain countries may regulate disposal of the battery used to power this product. Please consult with your local authority.

CAUTION

- INVISIBLE LASER RADIATION WHEN OPEN
- DO NOT STARE INTO BEAM OR VIEW DIRECTLY WITH OPTICAL INSTRUMENTS
- CLASS 1M INVISIBLE LASER RADIATION WHEN OPEN
- DO NOT VIEW DIRECTLY WITH OPTICAL INSTRUMENTS

The validity of the CE marking is restricted to only those countries where it is legally enforced, mainly in the countries EEA (European Economic Area).

Power Sources

To use the AC power adaptor (C)

- 1 Connect the AC power adaptor to an AC outlet.

To use the batteries (B)

Use only the following batteries for your CD player:

Dry batteries

- LR6 (size AA) alkaline batteries

To insert the batteries

- 1 Open the battery compartment lid inside your CD player.
- 2 Insert two batteries by matching the ⊕ to the diagram in the battery compartment and close the lid until it clicks into place.

Battery life* (approx. hours)

(When the CD player is used on a flat and stable place.)
Playing time varies depending on how the CD player is used.

	G-PROTECTION	
	ON	OFF
Two Sony alkaline batteries LR6 (SG) (produced in Japan)	50	45

* Measured value by the standard of JEITA (Japan Electronics and Information Technology Industries Association).

To check the remaining power of the batteries

You can check it in the display.
Replace the batteries when “Lo batt*” flashes.

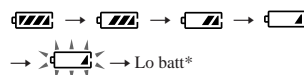

*Beep sounds.

Notes

- The indicator sections of roughly shows the remaining battery power. One section does not always indicate one-fourth of the battery power.
- Depending on operating conditions, the indicator sections of may increase or decrease.

Notes on using the dry batteries

- Be sure to remove the AC power adaptor.
- When the batteries are depleted, replace both batteries with new ones.

Playing a CD

To insert a CD

- 1 Slide OPEN to open the lid (A).
- 2 Fit the CD to the pivot, then close the lid (D).

Notes

- This CD player can play CD-Rs/CD-RWs recorded in the Compact Disc Digital Audio (Audio CD) format, but playback capability may vary depending on the quality of the disc and the condition of the recording device.
- This product is designed to play back discs that conform to the Compact Disc (CD) standard. Recently, various music discs encoded with copyright protection technologies are marketed by some record companies. Please be aware that among those discs, there are some that do not conform to the CD standard and may not be playable by this product.

To operate the CD player

Button/Switch	Function/Operation
1 ◀▶ (AMS*/search)	Press ◀ or ▶ once to find the beginning of the current/next track. Press ◀ or ▶ repeatedly to find the beginning of the previous/succeeding tracks. Press and hold ◀ or ▶ to go backward/forward quickly.
2 ⏮ (play/pause)	• Press to start play. Press again to pause play. To play from the first track, press for 2 seconds or more while the CD player is stopped. • Also press to enter the selection.
3 HOLD	Use to lock the controls to prevent accidental button presses.
4 DISPLAY/MENU	• Press once to display “track number and remaining time of the current track.” Press twice to display “the number of tracks left and the time remaining on the CD.” Press three times to display “track number and elapsed playing time (normal display).” • Also press to enter the menu and to enter the selection.
5 P MODE/↺ (play mode/repeat)	During play, press repeatedly until the play mode you want appears on the display. No indication: Normal play “1”: Single track play “SHUF”: Shuffle play “”: Bookmark track play “PGM”: PGM (program) play To repeat the play mode you selected, press and hold until “↺” appears.
6 SOUND*2	• Use to emphasize the bass-boosted sound. Press repeatedly to select BASS or BASS . BASS enhances more than BASS .*3 • Also use to keep down the maximum volume to protect your hearing. Press and hold until “AVLS*4” appears in the display. The AVLS function is turned on. To turn off the AVLS function, press and hold again until “AVLS” disappears.
7 ■ (stop)	Press to stop play.
8 VOL+/-	Press to adjust the volume.

*1 AMS = Automatic Music Sensor

*2 If you disconnect the power sources, all settings return to the defaults.

*3 If the sound is distorted when using the SOUND function, turn down the volume.

*4 AVLS = Automatic Volume Limiter System

To remove the CD

Remove the CD while pressing the pivot (E).

C

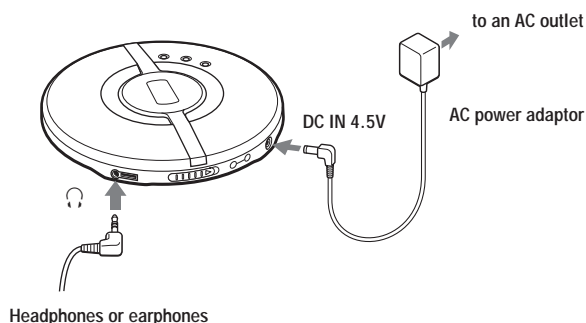



Playing your favorite tracks by adding Bookmarks

(Bookmark track play)

You can add Bookmarks to up to 99 tracks for each CD. You can use this function for up to 5 CDs.



To add Bookmarks

- 1 During playback of the track where you want to add a Bookmark, press and hold **▶||** until “” (Bookmark)” flashes on the display.

When the Bookmark has been added successfully, flashing of “” becomes slow.

- 2 Repeat step 1 to add Bookmarks to the tracks you want.

To listen to the tracks with Bookmarks

- 1 Press P MODE/ repeatedly until “” flashes.
- 2 Press **▶||**.
“” lights up in the display and the playback of the tracks with Bookmarks starts.

To remove the Bookmarks

During playback of the track with a Bookmark, press and hold **▶||** until “” disappears from the display.

To check the tracks with Bookmarks

During playback of the tracks with Bookmarks, “” keeps flashing slowly in the display.

Notes

- During playback of the tracks with Bookmarks, tracks are played in order of track number, and not in the order you added the Bookmarks.
- If you try to add Bookmarks to the tracks on the 6th CD, the Bookmarks of the CD you played back first will be erased.
- If you remove all power sources, all Bookmarks stored in memory will be erased.

Playing tracks in your favorite order (PGM play)

You can program the CD player to play up to 64 tracks in your favorite order.

- 1 During playback, press P MODE/ repeatedly until “PGM” appears.
- 2 Press **◀◀** or **▶▶** to select a track.
- 3 To enter the selected track, press and hold **▶||** until the playing order increases by one.
“00” appears and the playing order increases by one.
- 4 Repeat steps 2 and 3 to select the tracks in your favorite order.
- 5 Press **▶||** to start PGM play.

To check the program

During programming:

Press and hold **▶||** repeatedly before step 5.

During the PGM play:

Press P MODE/ repeatedly until “PGM” flashes, then press and hold **▶||** repeatedly.

Each time you press **▶||**, the track number appears.

Notes

- When you finish entering the 64th track in step 3, the first selected track appears in the display.
- If you select more than 64 tracks, the first selected tracks are erased.

Other functions

You can make the following settings using the menu.

The timer function

You can set the CD player to stop playback automatically within a range of 5 to 95 minutes at 5 minute intervals. When the CD player is playing and the timer function is activated, the track number flashes on the display.

The G-PROTECTION function

This function has been developed to provide excellent protection against sound skipping during many active uses.*

Turning off the beep sound

You can turn off the beep sound that is heard from your headphones/earphones when you operate your CD player.

- * Sound may skip:
– if the CD player receives stronger continuous shock than expected,
– if a dirty or scratched CD is played or
– when using poor-quality CD-Rs/CD-RWs or if there is a problem with the recording device or application software.

How to set

- 1 While play is stopped, press DISPLAY/MENU until “t-SEt” appears.

From this step on, start the next operation within 15 seconds after you finish the previous operation. If the indications on the display disappear, start from step 1 again.
- 2 Press **◀◀** or **▶▶** to select the Menu 1 item, then press DISPLAY/MENU or **▶||**.
Menu 2 item starts flashing.
- 3 Press **◀◀** or **▶▶** to select the Menu 2 item, then press DISPLAY/MENU or **▶||** to enter the selection.

When the item has been entered securely, the item stops flashing.

To return to the previous screen, press **■**.

To cancel the setting operation, press and hold **■**.

List of menus

Setting	Menu 1	➔	Menu 2
Timer*	t-SEt	--	05 : : 95
G-PROTECTION	SEt	on off	
Turning off the beep sound	bEEP	b on b off	

* You can set this item during both play and stop. The time set is estimated.

Notes

If you disconnect the power sources, all settings return to the defaults.

Precautions

On safety

- Should any solid objects or liquid fall into the CD player, unplug it and have it checked by qualified personnel before operating it any further.
- Do not put any foreign objects in the DC IN 4.5 V (external power input) jack.

On power sources

- When you are not using the CD player for a long time, disconnect all power sources from the CD player.

On AC power adaptor

- Use only the AC power adaptor supplied. Do not use any other AC power adaptor. It may cause a malfunction.

Polarity of the plug



- Do not touch the AC power adaptor with wet hands.
- Connect the AC power adaptor to an easily accessible AC outlet. Should you notice an abnormality in the AC power adaptor, disconnect it from the AC outlet immediately.

On dry batteries

- Do not throw the batteries into fire.
- Do not carry the batteries with coins or other metallic objects. It can generate heat if the positive and negative terminals of the battery are accidentally contacted by a metallic object.
- Do not mix new batteries with old ones.
- Do not use different types of batteries together.
- When the batteries are not to be used for a long time, remove them.
- If battery leakage occurs, wipe off any deposit in the battery compartment, and install new batteries. In case the deposit adheres to you, wash it off thoroughly.

On the CD player

- Keep the lens on the CD player clean and do not touch it. If you do so, the lens may be damaged and the CD player will not operate properly.
- Do not put any heavy object on top of the CD player. The CD player and the CD may be damaged.
- Do not leave the CD player in a location near heat sources, or in a place subject to direct sunlight, excessive dust or sand, moisture, rain, mechanical shock, unlevelled surface, or in a car with its windows closed.
- If the CD player causes interference to the radio or television reception, turn off the CD player or move it away from the radio or television.
- Discs with non-standard shapes (e.g., heart, square, star) cannot be played on this CD player. Attempting to do so may damage the CD player. Do not use such discs.

On headphones/earphones

Road safety

Do not use headphones/earphones while driving, cycling, or operating any motorized vehicle. It may create a traffic hazard and is illegal in some areas. It can also be potentially dangerous to play your headsets at high volume while walking, especially at pedestrian crossings. You should exercise extreme caution or discontinue use in potentially hazardous situations.

Preventing hearing damage

Avoid using headphones/earphones at high volume. Hearing experts advise against continuous, loud and extended play. If you experience a ringing in your ears, reduce volume or discontinue use.

Consideration for others

Keep the volume at a moderate level. This will allow you to hear outside sounds and to be considerate to the people around you.

Maintenance

To clean the casing

Use a soft cloth slightly moistened in water or a mild detergent solution. Do not use alcohol, benzine or thinner.

To clean the plugs

If the plugs become dirty, there is no audio or noise is heard. Clean them with a dry soft cloth periodically.

Troubleshooting

Should any problem persist after you have made these checks, consult your nearest Sony dealer.

“Hold” appears in the display when you press a button, and the CD does not play.

→ The buttons are locked. Slide HOLD back.

The volume does not increase even if you press VOL + repeatedly.

→ Press and hold SOUND until “AVLS” disappears from the display.

The battery compartment lid is detached by an accidental drop, excessive force, etc.

→ Attach it as illustrated below.

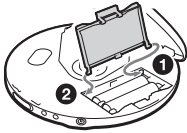

Specifications

System

Compact disc digital audio system

Laser diode properties

Material: GaAlAs

Wavelength: λ = 780 nm

Emission duration: Continuous

Laser output: Less than 44.6 μW (This output is the value measured at a distance of 200 mm from the objective lens surface on the optical pick-up block with 7 mm aperture.)

Power requirements

- Two LR6 (size AA) batteries: 1.5 V DC × 2
- AC power adaptor (DC IN 4.5 V jack):
220 V, 50 Hz (Model for China)
120 V, 60 Hz (Model for Mexico)

Dimensions (w/h/d) (without projecting parts and controls)

Approx. 135.8 × 22.8 × 135.8 mm

Mass (excluding accessories)

Approx. 180 g

Operating temperature

5°C - 35°C (41°F - 95°F)

Design and specifications are subject to change without notice.

Supplied Accessories

AC power adaptor (1)

Headphones/earphones (1)